

April 2017



WOODCRAFT[®]

Helping You Make Wood Work[®]

NEW! SYSROCK
Bluetooth
Integrated
Radio

FESTOOL

**Spring Cleaning Can Wait ...
The New Festool[®] Domino[®]
Connector System Comes First!**

See Pages 2, 5-9 For
FESTOOL From Woodcraft

Sale prices good March 24 through April 27, 2017



NEW

FESTOOL® Domino® Connector Set

Break through the limits of shop-built pieces and on-site construction with the use of knock-down hardware. Create, build, and finish full-sized constructed pieces, and then quickly disassemble, move, and reassemble them with only a hex wrench. This hardware works with the Domino XL (DF 700) Joiner to create flat or corner joints. Corner and flat connectors provide simple and quick connections without the need for templates or complex measuring. Colored cover caps provide high-quality corner connection appearance. Connectors require the use of a 14mm Domino cutter (sold separately, p. 7).

This complete set includes all the hardware necessary to construct 32 complete corner connections,

as well as 16 complete double-ended flat connections. Includes: 32x Anchor Bolts, 16x Double Headed Bolts, 128x Dowel Shells, 32x Expansion Bolts, 64x Transverse Anchors with Studs, 64x Widening Half-Shells, 32x Silver Cover Caps, 32x Dark Brown Cover Caps, 32x Light Brown Cover Caps, 32x 14x75 Birch Dominos, Instructions, 4mm Hex Wrench and a T-LOC SYS 2.

201353 \$259.00



NEW

FESTOOL® SYSROCK BR10

Fill the shop or jobsite with big sound from the feature rich, compact SYSROCK. This amazing unit provides FM Radio reception, Bluetooth streaming capability, hands-free calling, aux-in, and much more. Listen to your tunes on your terms with either corded or cordless functionality. Dynamic Sound Processor (DSP) automatically adjusts the sound at all volume levels to produce full and natural sound with rich bass without distortion. Built-in microphone lets you take calls from your phone hands-free. All this provides the perfect sound for your day even in extreme work conditions. Includes: SYSROCK, AC Adapter, AUX Cable and Carry Bag.

- Compact Size: 4" W x 6" H x 4 1/8" D
- Big Sound: 10 Watt 2 1/2" 8ohm Neodymium Speaker
- Phone capable with Bluetooth (4.1 Receiver)
- Powered By: AC Adapter (included) or Festool Flat Pack Batteries (not included)
- Battery Interface: Flat Pack Batteries 12.0V-18.0V
- FM Reception - 4 programmable preset station selections
- AUX-IN for use with non-Bluetooth devices
- Splash-Proof: IPX3 Rating

200184 \$119.00

Systainer contents for display only, are not included



NEW

TANOS® T-LOC SYS-Sort IV/3 Systainers

The Tanos T-LOC SYS-Sort IV/3 systainer offers 3 levels of parts and tool storage. Each drawer opens with a stack for easy access. Drawers can be customized with bins or the optional drawer accessory pack (sold separately) to fit your needs exactly. Ideal for hand tools, fasteners and other small parts. Like other systainers, the SYS-Sort IV/3 can be connected by the T-LOC to other systainers, Tool-Box, Storage-Box and systainer@classic Line to make the ultimate storage system. Each SYS-Sort includes 2 drawer separators. Made in Germany.

161974 anthracite **\$155.00**
161974LG light gray (shown) **\$155.00**

Accessory Pack

Set includes four (4) medium boxes, eight (8) small boxes, three (3) dividers and two (2) foam pieces.
161975 drawer accessories **\$25.00**

Systainer contents for display only, are not included

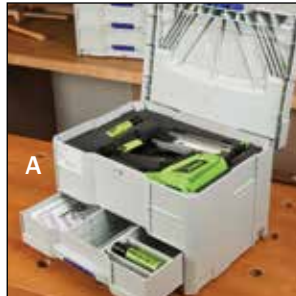

NEW

TANOS® T-LOC SYS-Combi II And III Systainer®

The open storage space of a SYS II or SYS III systainer® on top and a handy small parts storage drawer on the bottom gives you optimum organization.

- Pullout divided drawer for small parts.
- Open storage accepts available systainer@cc.
- T-LOC catch connects additional systainers
- Easy access to your tools.

Ideal for storing a tool in the top and the accessories in the drawer. Includes labels and 2 drawer separators. Made in Germany.

161790 SYS-Combi II anthracite **\$140.00**
161790LG (A) SYS-Combi II light gray **\$140.00**
161973 SYS-Combi III anthracite **\$150.00**
161973LG SYS-Combi III light gray **\$150.00**



NEW

FESTOOL® SysLite DUO-Plus Work Light

Jobsite lighting is more than just putting light in a room. It is about truly seeing the surface you are working on in the correct color and without hot spots in the center. The SysLite DUO is a hard-wired AC lighting solution with 8,000 lumens that projects an evenly diffused light over 180° with a color temperature of 5000 Kelvin. Designed for the jobsite, the SysLite DUO is impact and water-resistant and meets IP 55 standards for dust and water intrusion. With the LED service life rated at 10,000 hours, the SysLite DUO will provide unmatched lighting for many years to come.

769967 \$300.00



woodcraft.com is ALL NEW!

- Mobile Device Integration • Greater Detail • Improved Search • More Featured Articles
- Instructional Videos • More Blog Features • Find Your Local Store

+ Blog Adventures



+ Integrated With





Lock-Jaw CNC Track System

The Lock-Jaw Track was designed and engineered for CNC clamping operations to provide high strength, low profile workpiece security, by means of: Track, Stop, and Lock-Jaw Clamp. The Lock-Jaw Clamp secures a workpiece 1/8" above the track and locks the workpiece into position using a 22.5° lock screw, so the Lock-Jaws move simultaneously forward and downward. The Track has a toothed top surface to mate with the Stop's bottom teeth, to move the Stop in small, consistent increments along the Track, then lock it down. Tracks are 12" long and can be secured to an MDF top or workbench with 10-32 screws or #8 wood screws (not included). Customize The Lock-Jaw by purchasing additional Tracks and Lock-Jaw Clamps. All components are hardened steel with a black oxide coating. System includes: Two 12" Tracks, Two Stops, Two Lock-Jaw Clamps and Four Machine Screws.

- 161500 (A) Lock-Jaw Track System\$99.99
- 161501 Lock-Jaw Track\$39.99
- 161502 Lock-Jaw Stop and Clamp Set\$9.99



Door And Drawer Bumpers

Made of 100% polyurethane, with no plasticizer, oils or fillers to ensure they will not mar, scratch or stain any surface. The adhesive backing is considered the strongest, most effective adhesive in the industry. All bumpers are made of clear material with easy "peel-off" application.

- 153559 .500" x .150" round SD, 25 pcs. \$3.99
- 153560 .500" x .200" round SD, 25 pcs. \$3.99
- 153561 .312" x .080" round, 25 pcs. \$3.99
- 153562 .500" x .140" round, 25 pcs. \$3.99
- 153563 .500" x .120" square, 25 pcs. \$3.99
- 153564 1" x .180" square, 10 pcs. \$7.99

WE HAVE A STORE NEAR YOU!



- Hand Tools • Hardware •
- Power Tools & Accessories •
- Lumber • Classes & Demos •
- Expert Advice •

© 2017 Woodcraft Supply, LLC. "Helping You Make Wood Work" is a trademark of Woodcraft Supply, LLC. Retail store pricing and promotions may vary from catalog listings. Sale prices good March 24 through April 27, 2017, unless otherwise noted. Not responsible for typographical, photo or print errors. May not be reproduced in whole or in part by any optical, digital or electronic means without our express, written permission. Printed in USA.

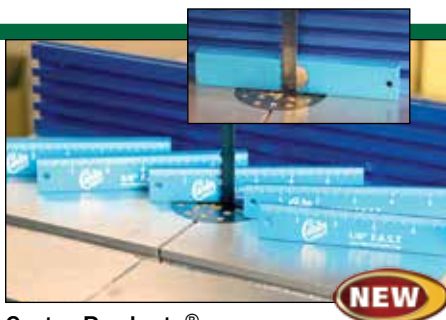

Carter Products®

F.A.S.T.™ Fence Alignment System Tool

Did you know that a bandsaw blade could change its angle as much as 18° depending on where it rides on the top or bottom wheel? Multiply that over the length of the table, and many fences can be as much as 3/4" out of square. The F.A.S.T. Fence Alignment System Tool from Carter Products is a simple and easy magnetic design that allows you to place it on the blade and determine that you are in that sweet spot for accurate cutting. It has a notch for the teeth so you can be sure you are perfectly flat against the body of the blade every time. The F.A.S.T. also has a ruler for determining fence distance. F.A.S.T. Combo Pack includes 1/8", 3/16", 1/4", 3/8" and 1/2" bars to allow you to precisely align the fence square to the blade and to the exact distance from the blade to the fence. Magnetic bars attach to each other to create any width desired between your blade and fence. For easy storage, the F.A.S.T. system comes with an adhesive backed foam drawer insert for easy organized storage. Likewise being magnetic, the F.A.S.T. bars attach directly to your saw for easy access. The F.A.S.T. bars are also a great tool for setup and confirmation of router bit depth by simply placing the desired depth of cut bar on either your router table or router base and adjusting the bit to the same height as the thickness of the bar.

- 868100\$49.99



WoodRiver®

8-Pocket Chisel Roll

Tools sold separately

Specially designed to store WoodRiver® chisels, the WoodRiver® 8-Pocket Chisel Roll will keep your chisels and other small hand tools organized. Keep it rolled up for ready-to-go use, or hang it on your pegboard, shop wall or side of your woodworking machine with the built-in grommets. Adjustable straps allow the roll to accommodate your items. Expanded: 17" x 12 3/4"; rolled size, empty: 13" x 6 1/2" x 2" (approximate). Black.

- 162068\$14.99



DAP® Rapid Fuse™

Rapid Fuse™ is a CA (cyanoacrylate) based adhesive fully repositionable for up to 3 minutes and ready to plane, sand, stain or finish in only 30 minutes. Also works on other surfaces such as melamine, particle-board, rubber, steel, glass, stone and more. Available in 4 oz. bottles only.

- 162085\$10.99



PRODUCT INDEX

CATEGORY	PAGE
All New Products.....	2-2J, 161, 164-167
ON SALE NOW!	2B, 2C, 168-170
Books/DVDs	
.....2B, 2G, 2J, 21, 31, 55, 62, 63, 65, 66, 89, 99	
Carving	2I, 89, 90-101
Chisels.....	2A, 2G, 2I, 2J, 67, 68, 69-70, 94
Clock Supplies.....	135
Dust Collection.....	2F, 3, 6, 12, 13, 16-20, 101
Fasteners	23, 132-133
Files & Rasps	105-106, 169
Finishing.....	2B, 164, 166, 168, 70, 71, 114, 115-122
Glue & Epoxy	2A, 2B, 111, 112-114, 164
Hardware	2A, 122, 123-134
Japan Woodworker.....	68, 70, 168
Kits	2B, 2I, 135-146, 165-167
Marking & Measuring.....	
.....2C, 2F, 2G, 2I, 62, 72, 77, 78, 79-82, 90, 168, 169	
MULTI-TOOLS	14
Ordering Information	162
Order Form.....	163
Pen, Pencil Kits, Acc.	2B, 140-144, 165, 166
Picture Framing	47
Planes.....	63-67, 68
Pneumatics	15
Power Carving & CNC.....	2A, 2B, 2I, 101, 102-103, 169
Power Tools	2F, 3-14, 161, 166, 170
Power Tool Acc.	
2, 2A, 2C-2F, 2H, 2I, 21-30, 55, 56, 137, 166, 168, 169	
Project Supplies.....	2A, 2B, 2E, 2F, 136-139, 144, 164-169
Routers & Acc.	30-36
Router Bits	2E, 34, 35, 37-40
Safety	20, 21, 42, 43, 89
Saws	2G, 51-55, 62, 67, 68, 168
Sanding & Scraping.....	2F, 10-13, 76, 106-111, 168, 170
Sharpening	2J, 82, 83-89, 165
Sharpening Service	55
Shop Accessories	
.....2A-2G, 36, 41-44, 63, 161, 165, 168, 169	
Systainer	2, 42, 66
Timber Framing.....	67
Vises & Clamps	
.....2A, 2C, 2D, 2G, 2H, 2J, 17, 22, 45-49, 161, 168	
Wood	2A, 148, 150-160, 165, 168
Woodboring.....	2D, 2E, 56-61, 136, 138, 139, 149, 168
Woodburning	2B, 103, 104
Woodturning.....	2C, 71-78, 166, 170
Workbench Hardware	2G, 48, 49
Workbenches/Tables.....	2C, 2D, 2G, 48, 49, 50
BRAND	PAGE
APOLLO.....	115
BLACK DOG SALVAGE	122
BOSCH.....	9, 10
CARTER	2A, 28, 77, 166
CROWN	71, 81, 111
DeWALT Tools.....	14
DMT.....	86, 88
DREMEL	102
EARLEX.....	114
EASY WOOD TOOLS.....	74, 75
FESTOOL®	2, 5-9, 166
FLEXCUT®.....	2I, 82, 100, 101, 103
FORREST Saw Blades	54
FREUD.....	37, 40, 53
GENERAL FINISHES	119, 121, 168
GENERAL INTERNATIONAL Tools.....	2H, 14
HAFELE	124, 129, 131
HIGHPOINT®	122, 124, 125, 127, 129, 132-134
HTC.....	27, 29, 30, 41
INCRRA Tools & Acc.	24, 26, 36, 80
JESSEM	28, 32, 36
JET Tools.....	10
KOCH	86
KREG® Tools.....	2D, 2H, 22-25, 27, 31, 49, 60, 61, 131, 169
LAGUNA	13, 19, 55, 170
MAGSWITCH.....	22
MICRO JIG®.....	2H, 21
MILESCRAFT.....	2E, 22, 30, 57-59, 151
Next Wave Automation	4, 5
NORTON	2F, 88, 108
NOVA Tools.....	2C, 11, 76, 77, 166, 170
ONEIDA Air Systems.....	2F, 18-20
PFEIL®.....	2I, 2J, 69, 82, 90-99, 111, 168
PINNACLE® Tools.....	42, 46, 63, 67, 71, 80, 86, 87
PORTER-CABLE Tools.....	14, 15, 107, 109
POWERMATIC Tools.....	10
RIKON® Tools	2C, 10-12, 13, 19, 82, 166
SAWSTOP.....	2C, 3-5
SHAPTON.....	89
SJÖBERGS.....	2C, 2G, 50
SORBY.....	69-73, 85, 110, 166
STARRETT®.....	2G, 55, 78, 79
TANOS®.....	2, 66
TITEBOND	113, 153, 164
TORMEK	84
VERITAS®.....	2G, 51, 52, 78, 79, 83, 111
WATCO	116, 118
WATERLOX	117
WHITESIDE	35, 37-39, 137, 139
WIXEY™.....	2E, 23, 78, 81
WOODPECKERS®.....	29, 33, 36, 47, 52, 58, 78, 79, 146

On Sale Now!

Save 25%

Whiskey Wood® Bourbon Barrel Staves Cutting Board Kits

Cutting Board pieces have been milled approximately 3/4" wide x 15/16" tall and 17" long. The chime – the beveled edge that holds the top or bottom of the barrel in place – has been kept intact. In our shop we made several cutting boards and other projects with interesting designs incorporating the chime.

Small: 6 Pieces Make A Cutting Board Approximately 4 1/2" W x 3/4" T x 17" L

162066 Small reg. \$24.99 **SALE: \$18.74**

Large: 10 Pieces Make A Cutting Board Approximately 7 1/2" W x 15/16" T x 17" L

162067 Large (Shown)..... reg. \$39.99 **SALE: \$29.99**



Save \$4 \$799

WoodRiver® Alaskan ULU Knife Kit

- Versatile And Easy To Use
 - Constructed From 440C Stainless Steel; Polished To A Mirror Finish
 - Excellent For Slicing, Chopping, And Dicing
 - Center Of Force Is Concentrated Over The Middle Of The Blade
- 161198 • reg. \$11.99
Handle Material Sold Separately.



Save \$10 \$1549



Ash Baseball Bat Billet

- Northern White Ash From Pennsylvania And Upstate New York
 - Graded For Quality With Straight Grain
 - Suitable For College And Lower Levels Of Play
 - 2 7/8" In Diameter And 37" In Length
 - Vacuum-Dried To A Moisture Content Of 9-11%, Offering Superior Strength
- 152795 • reg. \$25.49



Save 25%

Accord Pen Kits

The Accord kit features a silky smooth single twist mechanism, premium Schmidt® cartridges, and durable platings. Kit requires a 3/8" pen maker's bit and a 3/4" x 3/4" x 5" pen blank (both sold separately).

- 159229 Chrome reg. \$19.99 **SALE: \$14.99**
 159320 Gunmetal \$22.99 **SALE: \$17.24**
 159231 5-Piece Replacement Tubes \$4.99
 159230 Bushings \$6.50



Save \$3 \$1199

WoodRiver® 3-Piece Garden Tool Turning Kit

- Durable Cast Aluminum Construction
 - Contains A Transplanter, Cultivator And Weeder
 - Polished To A High Sheen
 - Handle Material Sold Separately
- 160213 • reg. \$14.99



Save \$5 \$1999

BucketBoss® Duckwear SuperBib Apron

- 18 oz. Duckwear Canvas
 - 16 Pockets: 13 At Waist & 3 On Bib
 - Padded Shoulder Straps And Dual Hammer Loops
 - 23" Wide For Full Coverage
 - Quick-Release Belt Fits 27" – 52" waists
- 159349 • reg. \$24.99



Save \$2 \$1799

Home Workshop Setup the Complete Guide

If you have found yourself dreaming about that shop you've always wanted, this guide may help you get it much sooner. All you need to start are scissors, tape, and a little imagination. 88 pages, softcover.
158734 • reg. \$19.99



Save 25% \$1199

System Three BarrelBond 5-Minute Gel Glue 2 oz.

- Two-Part Epoxy Gel Formulation Is Easy To Mix And Use
 - Five-Minute Open Time Is Enough To Glue Up Multiple Pen Tubes
 - Gap Filling, Waterproof, Flexible, Easy To Trim, Easy To Sand, Non-Sagging, And Has An Unlimited Shelf Life
- 152719 • reg. \$15.99



Save \$1150 \$1999

120-Piece Diamond Tip Carving Burr Set

Includes 30 Profiles In Four Grits, 150, 240, 400 & 600
149386 • reg. \$31.50

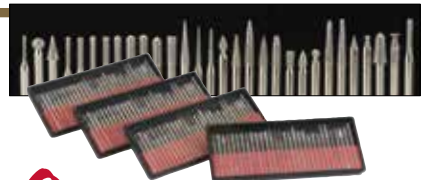

Save \$970 \$2499

Woodworker's Woodburner 30 Watt

- 30 Watt Professional Woodburning Tool
 - Four Woodburning Points
 - Tool Stand
 - Instruction Sheet
- 143072 • reg. \$34.69



Save \$450 \$1799

White China Bristle Brushes - Shop-Pack of 36

- Great For Applying Glue, Applying Stains, Or General Shop Use
 - Includes: 12 Each Of 1", 1 1/2" And 2" Brushes
- 147276 • reg. \$22.50



On Sale Now!



Save \$100
\$899⁹⁹

**Rikon 10-326
14" Deluxe Bandsaw**

The Rikon 14" Deluxe Bandsaw provides woodworkers with a powerful motor, impressive cutting capacities and patent pending technology. The powerful 1 3/4 HP, 115/230 dual volt motor offers two blade speeds and provides ample power for projects from 13 5/8" wide and 13" high.

Innovative Features:

- **Spring-Loaded, Tool-Less Blade Guides** – Fast, Easy Setting Of The Guides Without Wrenches!
- **Quick-Adjust Rip Fence** – Adjusts For Drift With The Simple Turning Of A Few Knobs! No Tools Needed.
- **Quick-Lock Table Trunnion System** – Handy Lever And Gear Unlock And Set Table Angles In Seconds!

865261 • reg. \$999.99

Buy A 3 HP Or 1 3/4 HP SawStop Professional Saw,
And Choose Between A FREE* Integrated Mobile Base
OR Overarm Dust Collection Assembly!



*Manufacturer's Mail-In Offer. Valid through April 30, 2017.
**Overarm Dust Collection requires a DC Blade Guard, which is included with the 3 HP Professional Cabinet Saw but must be purchased for the 1 3/4 HP model.

FREE UPGRADE*
OVERARM DUST COLLECTION OR INTEGRATED MOBILE BASE
\$199 VALUE



Save \$20
\$79⁹⁹

NOVA G3 Chuck

- Weight Is Only 3 lbs.
 - Handles Up To 14"-Diameter Bowls
 - Designed For Mini, Midi And Smaller Lathes With Up To A 14"-Diameter Swing
- 147016 • reg. \$99.99
(Insert Sold Separately.)



Save \$17⁵⁰
\$24⁹⁹

Heavy-Duty 1/2" Keyed Lathe Drill Chuck

- For Boring Out Hollow Vessels, Boxes, Vases, Depth Holes In Bowl Blanks And Much More
 - Accepts Bit Shanks 1/32" To 1/2", #2 MT
 - Allows Lathe To Function Like A Horizontal Drill Press
- 154750 • reg. \$42.50



Save \$50
\$199⁹⁹

Sjöbergs Hobby Bench with Birch Top 1" x 19 1/2" x 53"

Got space for a quality, compact workbench? Take a look at this Sjöbergs bench that features a birch top measuring 53" x 19 1/2" x 1", a birch tail vise and a pine trestle. Comes with four 3/4" wood bench dogs and an MDF shelf. The bench is the size and weight (52.8 lbs.) to fit that small space in your garage, an extra room or corner of your shop. Great for glue-ups, assemblies or a much needed third hand. Made in Sweden.
161650 • reg. \$249.99



Save 50%
WoodRiver® Stainless Steel Cabinetmaker's Rules

- Made Of Hardened Stainless Steel
- Deeply Engraved Graduations
- Finest Graduations Are In 64ths And .5mm
- Rear Face Displays Inch To Metric And Fraction To Decimal Conversion Table

140655	6"	reg. \$6.50	SALE: \$3.25
140656	12"	reg. \$13.99	\$6.99
140659	24"	reg. \$21.99	\$10.99
140657	40"	reg. \$29.99	\$14.99



Save \$35
\$39⁹⁹

Portamate® Six-Shelf Wood Rack

- Holds 110 lbs. Of Material Per Level, 6 Levels
 - Quick And Easy Installation
 - Powder-Coated Steel Tube Construction
 - Height: 39"; Shelf Depth: 12 1/4"
- 152860 • reg. \$74.99



Save \$40
\$119⁹⁹

Eclipse 10" Quick-Release Bench Vise

- Feature A Quick-Action Lever Which Disengages The Vise Screw And Permits Instant Adjustment
 - Heavy Cast-Iron Jaws & Solid Steel Slide Rods
- 152635 • reg. \$159.99

New Products



NEW

KREG® Mobile Project Center KWS1000

The Mobile Project Center is a workbench, sawhorse, assembly table, and clamping station all in one that provides a versatile work space for DIY, repair, and woodworking projects. It's easy to set up, folds to just 6 1/2" thick to store away, and provides a sturdy platform for all kinds of project tasks. Plus, the Mobile Project Center includes bonus clamping accessories, so it is ready to go to work, right out of the box. Multiple work modes provide maximum



versatility, including Kreg Joinery™. The large 27 3/4" x 31 1/2" work surface is constructed of durable polypropylene and supports a 350-lb. load capacity at a very comfortable 31 1/2" table height. Large, nonslip feet offer stable footing for the 40-lb. work center. Comes with auto-adjust Automaxx Bench Clamp, four Bench Dogs with Bench Brakes, two support brackets, two Trak Bushings, two Connection Keys and detailed owner's manual.

162291 \$159.99



NEW

KREG® Drawer Slide Jig

The KREG® Drawer Slide Jig ensures that drawers fit right and operate smoothly. Drawer Slide Jig fits ball-bearing, epoxy-coated, and under-mount slides. Built-in tabs easily align to support the slide and the drawers when attaching the slides. The KREG® Drawer Slide Jig includes two brackets that clamp in place inside the cabinet and align with the cabinet face frame or designated marks on frameless cabinets to support the drawer slide as you drill mounting holes. Minimum cabinet depth is 14", 12" slides and longer.

162006 \$24.99

KREG® Cabinet Hardware Jig

This jig works with almost any knob or pull style and is great for new or existing doors and drawers. Accurate hole placement and repeatable results with built-in measuring scales and adjustable guides. Adjustable fence locates guides 1" to 5" from edge. Indexed settings for locating drill guides on centerline, as well as 2 1/2", 3", 3 1/2", 4", 4 1/2", 5", 64mm, 96mm, 128mm on-center. A 3/16" (4.5mm) drill bit is required but not included.

162005 \$24.99



KREG® Custom Pocket-Hole Plug Cutter System

NEW

With the Custom Pocket-Hole Plug Cutter System, you can use pocket-hole joinery virtually anywhere by hiding the pocket holes with perfectly matched plugs that you create. A special Drill Guide Block slides into K3, K4 or K5 bench-top bases to match the angle of the pocket-hole jig with the specifically designed KREG Plug Cutting Bits. System includes plug cutting drill guide block, standard-sized custom plug cutting bit, stop collar and hex wrench. HD- and micro-sized custom plug cutter bits require the special drill guide block contained in the Custom Pocket-Hole Plug Cutter System. HD- and micro-sized custom plug cutter bits are available separately.



162474 (A) pocket-hole plug cutter sys. \$69.99
 162475 (B) std. pocket-hole plug cut. bit \$39.99
 162476 (C) micro pkt.-hole plug cut. bit \$39.99
 162477 (D) HD pocket-hole plug cut. bit \$39.99



NEW

Fisch® Wave Cutter Evolution Metric Forstner Bits

Fisch Wave Cutter technology enables these bits to drill splinter-free, true to size blind holes, for edge drillings and slant drillings in softwood and hardwood. The wavy peripheral cutting edge prevents the edges from wearing out, drilling 3 times the number of holes of conventional forstner bits before needing to be sharpened. Bits require 25% less power due to ideal cutting geometries. Metric sizes are required for many hardware installations such as Euro hinges and knock-down fasteners. 15mm - 30mm bits have 8mm shank; 32mm - 50mm bits have 10mm shank. All bits are 90mm long. **16-Piece Set** includes 12mm, 15mm, 16mm, 18mm, 20mm, 22mm, 24mm, 25mm, 26mm, 28mm, 30mm, 35mm, 38mm, 40mm, 45mm and 50mm sizes. 5-pc. set 6-pc. set

162588	15mm	*		\$19.99
162589	16mm			\$19.99
162590	18mm			\$19.99
162591	20mm	*	†	\$21.99
162592	22mm			\$21.99
162593	25mm	*	†	\$21.99
162594	26mm			\$24.99
162595	30mm	*	†	\$24.99
162596	32mm			\$29.99
162597	35mm	*	†	\$29.99
162598	40mm		†	\$39.99
162599	45mm		†	\$49.99
162600	50mm			\$54.99
162601	5-piece Set *			\$119.99
162602	6-piece Set †			\$199.99
162603	16-piece Set			\$379.99



NEW

ARBORTECH TURBO Shaft™

Designed to complement the Arbortech TURBO tool range or may be used as a stand-alone tool, the TURBO Shaft™ provides detailed freehand carving to perfectly combine efficiency and control. The TURBO Shaft fits most standard angle grinders and is fitted with replaceable carbide teeth for excellent performance and durability even when working with the hardest timber. The adjustable depth gauge makes it quick and easy to set the desired cutting depth. This is the perfect tool for deep narrow profiles, detailed sculpting, letter work, template work and much more.

161431 \$119.99



Woodcraft is proud to provide major funding for *The American Woodshop* with Scott & Suzy Phillips, now in its 24th PBS television season.



**Milescraft® Door Mortise Kits
#1214 And #1220**

Increase security and privacy in your home by replacing interior and exterior doors without damaging the jamb or door frame with these door mortise kits from Milescraft. #1220 HingeMate350 Door Mortise Kit includes templates for 2½", 3", 3½", 4" and 4½" hinges; 1⅝" x 2¾", 1½" x 2¼" strike plates; 1" x 2¼", 1⅝" x 2¼", and 1⅝" x 2¾" latch plates. Sturdy steel frame adjusts from 1⅜" to 1¾" doors and jambs. Includes durable carbide tipped ½" router bit with ball bearing eliminating the need for guide bushings, spring-loaded corner chisel for squaring routed corners and self-centering hinge bit. #1214 Hinge Mortise Kit includes templates for 2½", 3", 3½", 4" and 4½" hinges only; sturdy steel frame and ½" router bit with bearing. Both kits include Easy Measure Guide to simplify standard industry placement of your door hardware.

- 161958 1220 door mortise kit..... \$34.99
- 149404 (A) 1214 hinge mortise kit\$19.99
- 161959 ½" router bit with bearing\$9.99



**Milescraft® AccuDrillMate™
Portable Drill Guide #1318**

With the AccuDrillMate you can drill straight or angled holes, drill on the edge of a board or even round stock. All-metal construction AccuDrillMate provides the precision of a drill press with the ease of a hand drill. The drive shank attaches to your ⅜" or ½" power drill, while the keyed output chuck works with most ⅜" drill accessories. Plunge rods interlock with metal base for secure angle drilling and easy-glide bearings prevent cutting tool from hitting workpiece with adjustable depth-stop. The metal base has a scale with easy to read angles, V-grooves for centering round materials, and holes for permanent mounting. Also includes auxiliary handle and rubber nonslip base.

- 161999 \$34.99



Milescraft® TriGrips™

Instant, positive lateral stability on almost any kind of work surface without clamps! Special foam impregnated nonslip skin holds any type of material in place to rout, sand, drill, carve and paint without clamps. When on their flat side, TriGrips hold a workpiece 1⅜" above the benchtop, set on edge the self-adjusting internal ballast flows to the base for stability. A cone-shaped tip supports material 3" above the work surface. TriGrips support large workpieces in the corner, long, narrow workpieces along the middle or when grouped together form a concentrated center support.

- 161765 4-pack..... \$11.99



**Milescraft®
CabinetMate™ Drill Template**

The Milescraft CabinetMate Drill Template is an easy to use, durable jig that is a great alternative to shop-made jigs, which typically wear out after just a few uses. The CabinetMate has a rigid main body with two rows of 11 holes on a 32mm center spaced 1⅞" and 2½" from either edge of the jig. Included ¼" Shelf Pin Bit is a custom ¼" brad-point drill bit that rides in a spring-loaded guide to center within the holes of the main jig body. ¼" Shelf Pin Bit drills ¼" holes to be used with ¼" shelf pins. An additional feature that sets the CabinetMate jig apart from the rest is the ability to mark drilling locations for Euro-style hinges. The CabinetMate also includes a built-in closed storage compartment for your bit and indexing pins. Accessory 5mm ShelfPin Bit expands the capabilities of the CabinetMate Drill Template to install 5mm diameter shelf pins. Replacement ¼" ShelfPin Bit replaces a worn ShelfPin that was included CabinetMate Drill Template or gives you a spare in case you need it.

- 161760 (A) CabinetMate drill template ...\$24.99
- 161761 (B) accessory 5mm ShelfPin bit...\$9.99
- 161762 (C) replacement ¼" ShelfPin bit \$9.99

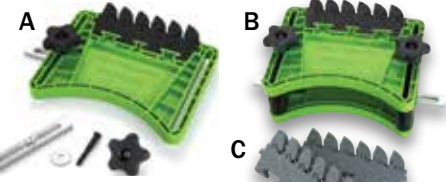

**BOW PRODUCTS
FeatherPRO Featherboards**

The FeatherPRO is a uniquely designed hold-down utilizing strong, non-marring EVA high density foam that is coupled with a living hinge for better control. High density foam feathers absorb vibration to minimize chatter or chatter marks for a cleaner cut. FeatherPRO Feathers are thicker and have greater surface contact area, which disperses the tension over a wider area, while the high density foam material and living hinge combination results in a smooth glide and greater control. EVA high density foam material included in the feather composition is very strong and durable. Feather foam will not mar softwoods, like other featherboards, when high tension is applied. Unique feather component is pressed into the FeatherPRO body so you can easily replace foam feathers or reverse feed direction quickly. Single FeatherPRO includes one Featherboard with one set of Standard Feathers and one set of mounting hardware. Stackable FeatherPRO includes two Featherboards with one set of Standard Feathers, one set of Ultralight Feathers, and two complete sets of mounting hardware and spacers for stacking. Choose between the Standard Feather or the optional Ultralight Feather for greater control and feedback when feeding more delicate workpieces.

- 162500 (A) FeatherPRO fthbrd., single...\$29.99
- 162501 (B) FeatherPRO stckble. fthbrds. \$59.99
- 162502 (C) ultralight fthrs. repl., grey.....\$14.99
- 162503 standard feathers repl., black.....\$14.99

New Products

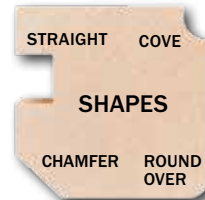

**WoodRiver®
Router Bit Starter Sets**

Start routing today with the WoodRiver Router Bit Starter Set. Four unique profiles – straight, cove, round over, and chamfer – cover most routing applications like edge treatments, grooves, rabbets, and joinery. Each bit (except straight) includes a bearing. WoodRiver Router Bits are suitable for cutting most woods, plywood, MDF and some plastics. Use the bits in your router table, handheld router or laminate trimmer. ¼" and ½" shank available.

- 162583 ¼" shank.....\$59.99
- 162584 ½" shank.....\$59.99



**WHITESIDE 6018
Front Face Door Edge Bit
With Bearing**

This Whiteside Front Face Door Edge Bit is ideal for creating a decorative profile on the front face of the door edge. Carbide-tipped blade produces clean cuts. ½" SH, ½" CL, ½" CD. Made in the USA.

- 161468.....\$43.77

**Wixey™
Drill Press
Laser Attachment**

The Wixey WL133 Drill Press Laser projects a set of bright crosshairs onto your drill press table precisely where the drill bit center will contact your workpiece. This allows you to instantly position and clamp your workpiece in place so that the hole is drilled exactly where you want it. The laser even works with large diameter bits that are difficult to position without repeated test positioning. The Drill Press Laser mounts to most drill presses and is easily adjusted to align the crosshairs with the center of your drill chuck. The crosshairs will stay on center, even when changing your drill press table height and regardless of your workpiece thickness. Rugged steel construction stands up to normal vibration. Requires two AA batteries, not included.

- 162567\$39.99

**HOTAK
29-Piece
Precision
Hobby Knife Set**

Our Hotak Precision Hobby Knife features a really comfortable handle and comes with 26 blades in six profiles: two #10 rounds, four #4 straight, six #11 skewers, six #1 skewers, four #3 skewers and four #12 skewers, a pair of tweezers and a small stone to help maintain your blades. Set comes in a plastic carry case, which holds all 29 pieces securely in place. Blades can be sharpened.

- 162189\$19.99

New Products

Oneida Air Systems® Super Dust Deputy® Deluxe 4" Kit

Finally, a turnkey kit from Oneida Air Systems made just for woodworkers with single-stage dust collectors! Single-stage dust collectors are great for small, hobbyist shops but they come with a cost ... fine dust quickly clogs the filter, reducing suction and leaving your tools as messy as ever! Worse still, there is nothing to protect your dust collector from damage should you accidentally suck up large wood chunks or fasteners. Oneida Air Systems' patented Super Dust Deputy® cyclone separates over 99% of dust and debris from the incoming airstream, virtually eliminating filter clogging, suction loss, and significantly prolonging the lifespan of your filter media. The 4" Super Dust Deputy Deluxe Kit has a small 16" footprint and assembled height under 42", making it the perfect shop accessory for small shops like your garage or even low ceiling basement shops. Cyclone molded from an industrial, abrasion resistant HDPE resin. Static dissipative construction safely conveys static charge build-up to the electrical ground, preventing harmful discharges. Retrofits to single-stage 1/2 HP to 3 HP dust collectors. Inlet Size: 4" OD (3.75" ID); Outlet Size: 4" OD (3.65" ID). Deluxe kit includes a lightweight, 15-gallon dustbin with quick-release latch.



162571\$209.99



Flexaust® Universal Wet/Dry Vacuum Kit

Professional grade kit fits most common shop vacuums with standard 2 1/4" inlet like Ridgid® Shop-Vac and Craftsman®. High quality 12-foot-long, 1 1/2"-diameter FLX Plus polyethylene copolymer hose reinforced with an integral polyethylene helix is crush resistant with smooth interior for efficient airflow. Hose is lightweight and flexible, even at low temperatures. 4" utility tool and 1 1/2" x 11" crevice tool simply slide into 1 1/2" swivel cuff for a secure connection.

162568\$59.99

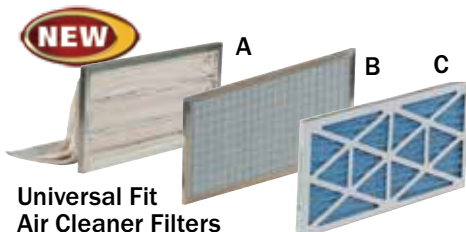

Universal Fit Air Cleaner Filters

These Universal Fit Filters are designed to fit multiple air cleaners that utilize 12" x 24" filters. These filters work with the JDS models 750 & 350, JET model AFS1000B, Rikon model 62-100 and the SuperMax model 810650.

162743 (A) inner replacement pocket filter,
1 micron, 12" x 4"\$57.99

162744 (B) electrostatic filter, washable,
5 micron, 12" x 4"\$44.99

162745 (C) outer replacement filter,
5 micron, 12" x 4"\$17.99

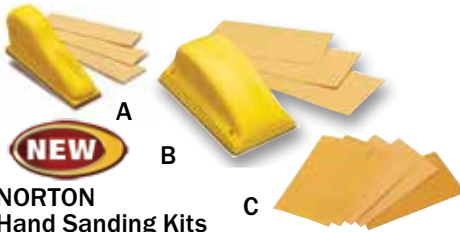

NORTON Hand Sanding Kits

Norton MultiSand Hook & Sand Detail and Finishing Block Sander Kits construction and ergonomic design reduce hand fatigue. The Smaller Detail Sander Kit fits well in hard to reach places. The larger Finishing Block Sander makes general hand sanding quick and comfortable. Detail Sander includes 30 hook and loop paper pieces; Finishing Block Sander has 5 pieces in coarse, medium and fine grits. Replacement sanding sheets available below.

161432 (A) Detail Sander Kit, 1" x 3 1/2"\$9.25

161433 (B) Finishing Block Sander Kit,
3" x 5 1/4"\$15.50

Finish Block Sanding Sheets - Includes 1 coarse (80 grit), 2 medium (120 grit) and 2 very fine (220 grit) sanding sheets. Cut to fit Detail Sander.

161434 (C)\$4.99



TITEBOND® Titewrap™

Band clamps are good for some difficult glue-ups, but getting the straps to stay put and setting the ratcheting mechanisms can be unwieldy. Titewrap™ fixes all of these issues. It's a stretchable 7 1/2" x 3/4" roll of "tape" that can be run and stretched to put clamping pressure where needed, but it doesn't damage the wood. It only sticks to itself, and with a little care, can be reused on the next project. We can envision using this stretchy tape on all kinds of projects where traditional clamping might not be ideal or you might not have enough traditional clamps to secure the project during glue-up. 1 roll of tape per package.

162164\$5.99

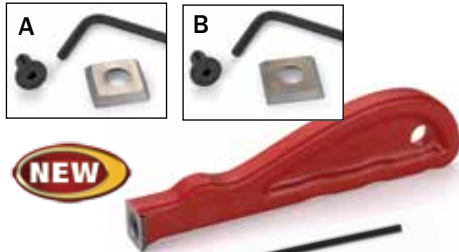

Woodpeckers® Mini-Scraper

Like most woodworkers, we at Woodcraft have lots of "scrapers" - basically anything steel with an edge. So, when we saw this Woodpeckers Mini-Scraper, we didn't get excited - until we started using it. Now we're hooked! The red molded plastic handle shape is comfortable to hold, and the carbide blade is thick, sharp and chatter-free. This scraper has four cutting edges, so a fresh edge can be rotated into position whenever the facing edge becomes dull. This Woodpeckers Mini-Scraper makes removing runny, drippy, excess wet or dry glue and cleaning up small areas of old finish a true pleasure. The Mini-Scraper is 5 3/8" long x 3/8" wide, with the carbide head 9/16" cambered square held in place by a hex screw. It comes with the Cambered Insert (blade) and a hex wrench.

162457 mini-scraper\$21.99

162458 (A) cambered blade\$11.99

162459 (B) square blade\$11.99

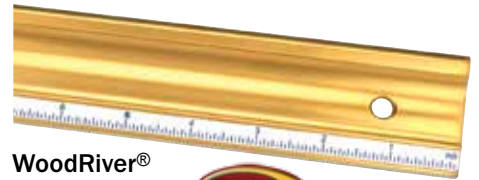

WoodRiver® Aluminum Straightedge

Perfect for checking power tools and more for flatness, our 24" and 38" WoodRiver® Aluminum Straightedge are great tools for gauging flatness most anywhere in your shop. They are made of extruded aluminum and will not rust, so they are an economical alternative to steel straight edges. The Straightedge is 1 7/8" high, 7/16" thick, and machined flat to .003" over the length of the straightedge. High-contrast tape measure in inches.

161739 24"\$29.99

161740 38"\$39.99



Kapro® Adjustable T-Square

The innovative sliding head of this T-square adjusts to any angle. The ABS end caps with ledges give you a hands-free hold. Features include: an anodized aluminum finish, strong lock screws, highly visible dual directional metric and imperial printed scales, and etched angle markings on the T-head. Folds for easy storage. 48" scale; 51" overall length.

162256 48" scale\$29.99



CLIFTON Ultra Thin Scraper Set

This new Clifton Scraper Set from Thomas Flinn in Sheffield, England, is made of carbon tool steel that is only 0.015" thick - just half the thickness of the company's standard scrapers, which are at 0.032". This thinner material offers more flexibility than a standard scraper and certainly less hand fatigue, because the tools are so much easier to flex. These are the perfect scrapers to use when more intricacy is required, such as in crafting musical instruments, and because they are so easy to flex, users of regular scrapers will want them as well. The 3-piece set contains a Gooseneck, Concave/Convex and a 5" x 2 1/2" Square.

162534\$20.99

Technical Questions?

Call 1-800-535-4486
For FREE help, and advice!



NEW

Veritas®

Tenon Saws

Be prepared for whatever cut you need to make with Veritas Tenon Saws. Rip or crosscut tooth options ensure you have the right tool for the job. Well-balanced with a spine molded from stainless steel powder, glass fiber and a polymer resin binder, Veritas Tenon Saws have a closed handle with Bubinga grip for increased control. The blade and handle-mounting bolt are molded into the spine, creating a solid body assembly. Each saw has a 16" blade. Rip blade has a 14° rake angle and 9 TPI; crosscut blade has a 15° rake angle, is filed with alternating 15° bevels and has 12 TPI.

161272 rip, 9 TPI (shown)..... **\$119.00**
 161273 crosscut, 12 TPI..... **\$119.00**



Rob Cosman

Medium Tenon Saw

Start cutting mortise-and-tenon joints right out of the box with the Rob Cosman Medium Tenon Saw. Slightly smaller than the standard tenon saw, this 11" Medium Tenon Saw has a 2" cut depth, making it large enough for most furniture projects. The weight of the blade reduces vibration, while the variable tooth set – 22 TPI to start and 12 TPI in the middle – ensures that you start and complete a straight cut. Brass back with ebony resin handle. Comes packed in a sturdy wooden crate. 0.025" kerf.

866409 **\$279.99**



NEW



SJÖBERGS

Junior/Senior Workbench

The Junior/Senior Workbench is a compact creative workstation for both children and adults. The bench may be assembled for two working heights, 25" and 34". But don't be fooled by its size; this 48-lb. sturdy, solid wood bench has features useful for woodworking and crafts, including two double rows of 3/4" bench dog holes and two vises. It is a great starter bench and is perfect for smaller workspaces. The Junior/Senior measures 19" wide x 39" long. Includes four bench dogs. Optional 22 1/16" wide x 18 1/8" high cupboard for the senior height is sold separately (159431). Shipping weight: 48 lbs.

142902 Jr./Sr. workbench..... **\$385.50**
 159431 (A) Jr./Sr. cupboard..... **\$90.75**

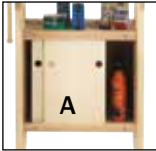

Stair Tread/Riser Gauge And Shelf Layout Tool

If you build stairs this tool is essential for laying out stair treads, risers or built-in shelves, ensuring a perfect cut the first time and reducing installation time. Made of top-grade Baltic Birch, the tool is sturdy, but won't mar your walls like steel versions. Large knobs will lock down quickly, and the tool folds up for easy storage. Extends from 30 1/2" to 49". Made to last in the USA.

159074 **\$99.99**



Rob Cosman Kerf X-10

Half-Blind Dovetail Kerf Extender

Create clean, smooth sides for your half-blind dovetails with the Kerf X-10. After you have made your cut for the side of a half-blind dovetail, place the blade of the Kerf X-10 into the kerf of the cut, and hammer in with a mallet. This action shears the portion of the cut that you would normally need to clean up later with a chisel. Brass back; mahogany handle. 0.025" saw plate.

866410 **\$99.99**



NEW

Rob Cosman

Dovetail Trainer

Get the angle of your next dovetail just right with the Rob Cosman Dovetail Trainer. This handy cutting aide allows you to cut straight, 10° left or right with a simple setup process. The lightweight tool won't throw off your sawing, but will help you gain the muscle memory for the correct position of your hand and arm when cutting. Use on saws with 1/4" thick back.

866411 **\$59.99**



NEW



STARRETT®

277 Toolmakers' Spring-Type Calipers And Dividers With Round Legs

Starrett 277 Series Toolmakers' Spring-Type Calipers and Dividers with Round Legs and Solid Nut are the finest tools of their type. They are designed for toolmakers and all good mechanics that require finer adjustment and better balance so a more sensitive "feel" can be obtained. Precision made to rigid Starrett standards throughout, features include hardened fulcrum stud, strong and flexible bow string, and centrally located leg adjustment to ensure smooth action.

841267 3" **\$64.99**
 840772 6"..... **\$77.25**



NEW

Hand-Cut Dovetails

The Rob Cosman Approach DVD

Rob coaches new student Dave through his first-ever hand-cut dovetail using Rob's "new" method. Watch and learn during two and a half hours of detailed instruction.

159920 **\$19.95**



NEW

WoodRiver® Stainless Steel Thickness Gauge

Just "pinch" your wood to read its thickness – from 1/32" to 2" – with this stainless steel gauge that features etched graduations for extended use. The expanded rear scale includes preset holes at 1/4" intervals for use as a go/no-go gauge.

162310 **\$14.99**

NEW

WoodRiver®

Table Leg Brackets

Use these heavy gauge steel WoodRiver Table Leg Brackets for attaching large legs to the bottom of tables/slabs and workstations. The powder coated black steel brackets come in two sizes: 159668 brackets fit legs that are a minimum of 3 1/2" square; 159669 brackets fit legs a minimum of 2 1/2" square. They attach with 8- #8 panhead screws and 8- #10 screws and can be used on even larger square legs. 2-piece set, enough for one leg.

159668 3 1/2" (shown) **\$29.99**
 159669 2 1/2"..... **\$24.99**



NEW

SJÖBERGS

Smart Workstation Pro

The Sjöbergs Smart Workstation Pro (33309) is a top quality portable workstation constructed from Premium clear European beech. It's ideal for wood-working, woodcarving and household repairs of all kinds. Just clamp or bolt (not included) the Pro to any convenient surface and start working. It's almost like having a full-sized Sjöbergs workbench where and when you need it. Includes four bench dogs with side springs. Dimensions: length 20 7/8" (working top 15 3/4"); width 14 3/8"; top thickness 1 5/8"; vise capacity 4 1/3" with a total weight of 22 lbs.

161388 **\$235.00**



NEW

SJÖBERGS Workbench Strong Vise

We all need a vise that we can count on while enjoying our woodworking passion. A smaller version of the popular Elite Vise, the Sjöbergs Adjustable Strong Vise is designed to fit most workbenches. Easy mounting and the adjustable design will keep the vise from racking. Mounting hardware not included.

159180 AV-15 vise **\$244.00**



New Products



DAMSTOM 38" Panel Clamp

Wide panel glue-ups can be a real pain – especially trying to keep even pressure across the length of the panel. That's when this uniquely designed clamp from Damstom Woodworking Panel Clamps rises to the occasion, or should I say "keeps a level head." The D300 GRAY is designed to erase completely the curvature of the wooden pieces, maintains even pressure and keeps all narrow components aligned for a flat panel every time. 38" capacity covers even the widest furniture tops with powder-coated rails so glue doesn't adhere to clamp, making it easy to clean. Make wood panels with different thicknesses from 3/4" up to 4 1/2". Articulated handle has been designed for less fatigue, even at higher pressure, with ACME thread that tightens faster and with finer control to prevent "glue-starving" the joint. This clamp is a must-have the next time you are gluing together a wide panel.

162565 38" panel clamp, each\$59.99

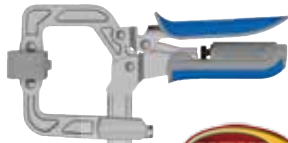

KREG Automaxx® Auto-Adjust Bar Clamps

When you want the durability and auto-adjust convenience of Automaxx® clamping, but you need more clamping capacity, turn to Auto-Adjust Bar Clamps with Automaxx Technology. Just like other Kreg Automaxx clamps, these bar clamps adjust automatically when you change material sizes. Just slide the clamp jaws against your workpiece, and then squeeze the handles. Automaxx Technology does the rest, closing the clamp with predictable, dependable clamping pressure every time. That clamping pressure is easy to regulate, as well, thanks to a simple thumbscrew that dials in the pressure you need, from gentle to highly powerful clamping. Auto-Adjust Bar Clamps are available in three lengths, 8", 16" and 24", each with 1 1/2" reach. Whether the job requires holding large pieces during assembly or holding workpieces in place on your bench, Auto-Adjust Bar Clamps suit a wide variety of project needs.

Each
162024 8" Auto-Adjust bar clamp\$29.99
162025 16" Auto-Adjust bar clamp\$34.99
162026 24" Auto-Adjust bar clamp\$39.99



GENERAL TOOLS EDGEWEDGE Pry Kits

The EDGEWEDGE Pry Kits flexible or rigid tools will get you out of tight spots without marring surfaces. Each kit contains three pry tools, two straight – short and long – tools and one long, radiused tool. Use them as pry bars, shims or levelers. The flexible version (yellow) works best where you need to gently remove items, and rigid version (black) is for heavier use. If the tips get rough, simply reshape or resurface with a file. Made in USA.

422225 flexible.....\$7.99
422226 rigid.....\$9.99

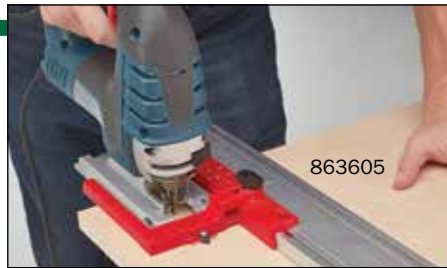

Bora® WTX Modular Clamp Edge Saw Guide System

The Bora WTX Modular Clamp Edge Saw Guide System provides a complete solution for making true, accurate cuts with virtually any circular saw, jigsaw and router. The basic system uses the WTX Modular Clamp Edge Saw Guide alone to guide your portable power tool. The compact, portable **WTX Clamp Edge Saw Guide** features fast setup, holds tight and has a quick-release clamping mechanism. **36" size** works well for crosscutting doors and countertops. **50" size** is perfect fence for crosscutting 4'-wide sheets of plywood or OSB. **100" size** forms optimum guide for ripping 8' sheets of plywood, MDF or OSB. Best of all, the Clamp Edge Guide is modular because it doesn't use a heavy steel rod to hold the clamp follower in place.

863608 circular saw plate.....\$29.99
866261 rip guide attachment.....\$19.99
866262 jigsaw guide.....\$9.99
866260 router dado guide.....\$49.99

Modular Clamp Edge Saw Guide Accessories
The rigid aluminum extrusion can be extended simply by adding optional **50" Add-on Extension Track**. The smooth-sliding **Circular Saw Plate** connects to your circular saw in seconds, and then rides along your Modular Clamp Edge Guide for near table saw precise crosscuts. You can add the versatile **Rip Guide Attachment** to your Circular Saw Plate to gain the same ripcut precision without being limited by the length of your Clamp Edge Guide. **Jigsaw Guide** glides smoothly in the T-track of your WTX Clamp Edge Guide, while the jigsaw is secured in position for a straight cut. **Router Dado Guide** comes with a 1" PC-style guide bushing for easy mounting and can be adjusted for bit size and board thickness, ensuring that pieces of slightly smaller than standard sizes can fit tightly. The Bora WTX Clamp Edge Saw Guide will help you build faster, with more professional results.

863605 36" modular Clamp Edge.....\$47.99
863607 50" modular Clamp Edge.....\$54.99
866259 100" modular Clamp Edge.....\$99.99
863606 50" add-on extension track.....\$47.99



WoodRiver® 2" Heavy-Duty Table Vise

This little portable cast-iron table vise has a host of features - first, at 5 lbs., 15 oz., it has the heft and feel of a much larger vise. Second, it clamps to any surface from 1" to 2 1/2". Next, you'll never find yourself on the wrong side of the vise in an awkward position because it swivels a full 360°. Finally, the 2 1/4"-wide, 2"-capacity jaws will hold big stuff, as well as delicate small work, with aplomb, and just for good measure it has a small anvil on the back to straighten nails or shape a little metal. We tested this little/big vise in our shop and think it is a solid performer.

162415.....\$19.99



Micro Jig® MATCHFIT™ Dovetail Fixture And Jig Clamps

MATCHFIT™ Dovetail Clamps can hold parts, jigs, and fences without being in the way. The fixed clamp leg is contained within a dovetail groove to offer maximum versatility without interference. Simply rout a 3/8" deep 1/2" x 14° dovetail slot in your fence or jig for infinite work holding possibilities. The dovetail design gives you the freedom to create your own track grooves, allowing you to clamp virtually anywhere! Build your own extension tables, clamping tables, and guide rails using the MATCHFIT™ clamps to anchor the jig or hold the workpiece. For your biggest projects, build taller fences for table saws, bandsaws or router tables simply by routing two parallel grooves in a 1/2" or thicker panel. Reversible clamping leg with acme thread, throat depth: 2 3/8", clamp capacity: 5 1/4", and clamp pressure: 595 lbs. open at 4". Includes one pair of clamps.

161950\$39.95



Micro Jig® MATCHFIT™ Dado Stop™

The MATCHFIT™ Dado Stop™ sets the shoulders of your cross dado using the actual part that will be fitted in the dado for a perfect fit without measuring or test cuts. The Dado Stop uses adjustable legs as a stop to make your shoulder cuts and then uses back and forth cuts to clear the center using a regular blade. Now intricate joinery angles on a table saw are possible with the Dado Stop. The Dado Stop can also be used as a safe and effective crosscut stop. The precise 3" length allows you to accurately set the rip fence scale for repeatable, accurate cuts. A single MicroJig® MATCHFIT™ Dovetail Clamp – (161950) not included – is necessary to attach the Dado Stop to your table saw fence. Micro Jig MATCHFIT™ Dovetail Clamps are sold separately in pairs.

866264\$19.99

PFEIL Swiss Made® Spoon Knives

A lot of folks are making wooden spoons for the kitchen. Spoons can be made any size from most any wood and can be shallow or deep, long or short. To form the "bowl" portion of the spoon, bent and spoon gouges can be used, but the better tool is a specially shaped knife called a Spoon Knife. Pfeil makes eight Spoon Knives – four bevel left and four bevel right with both round (deep) and half-round (shallow) curves to the blades. All come sharp and ready to use. To determine a tool's bevel orientation, look down at the logo with the blade of the tool pointed away from you. From that position, a bevel left tool has the bevel facing to the left, and a bevel right tool has the bevel facing to the right.

Large half-round knives have a 2½" cutting edge with a ½"-deep curve and large round knives a ¾"-deep curve to the knife.

- 161294** half-rnd. large, bevel left #21.... \$46.39
- 161295** half-rnd. large, bevel right #22.. \$46.39
- 161296** round large, bevel left #23..... \$46.39
- 161297** round large, bevel right #24..... \$46.39



Small half-round knives

have a 2" cutting edge with a ⅜"-deep curve and small round knives a ⅝"-deep curve to the knife.

- 161298** half-rnd. small, bevel left #25 \$44.79
- 161299** half-rnd. small, bevel right #26.. \$44.79
- 161300** round small, bevel left #27..... \$44.79
- 161301** round small, bevel right #28 \$44.79



PFEIL Swiss Made® Beveled Edge Chisels

Beveled Edge Chisels from Pfeil are crafted using the same Old-World craftsmanship, modern technology, and legendary Swiss attention to detail that have made Pfeil carving tools famous the world over. Pfeil uses only the finest Swiss alloy tool steel. Blades are heat treated individually, using the latest technology, and are expertly ground on all sides with a 25° main bevel on the cutting edge. Elm handles were chosen for beauty and feature an octagonal and slightly ovoid shape for improved control and comfort. However, there is something different about these beveled edge chisels! The side bevel is swept back towards the centerline as opposed to being parallel. This functional but very attractive design permits the blade to be used in some pretty tight places, such as cleaning up dovetails. Set includes the following: 6mm (¼"), 10mm (⅜"), 12mm (½"), 16mm (5/8"), 19mm (¾") and 26mm (1") chisels and a tool roll.

- 162516** 6mm (¼") \$34.99
- 162518** 10mm (⅜") \$36.99
- 162519** 12mm (½") \$37.99
- 162520** 16mm (5/8") \$38.99
- 162521** 19mm (¾") \$39.99
- 162522** 26mm (1") \$42.99
- 162526** 6-piece Set \$219.99



PFEIL Swiss Made® Violin-Maker's Knives

Swiss made Violin-Maker's Knives are crafted from Pfeil's special alloy chrome-vanadium steel and are double beveled and hardened through to the backside, making them easy to re-sharpen. These knives are razor-sharp and quite delightful to use for a variety of tasks. They excel at carving, scoring and are used as marking knives. The knives are all 160mm in length and available in six widths: 3.5mm, 6mm, 9mm, 12mm, 15mm and 19mm.

- 161302** (A) 3.5mm \$17.49
- 161303** (B) 6mm \$17.49
- 161304** (C) 9mm \$17.49
- 161305** (D) 12mm \$17.49
- 161306** (E) 15mm \$17.49
- 161307** (F) 19mm \$17.49



WoodRiver® 20-piece Rotary Carbide Burr Set

Detailing a woodcarving? Trimming some burr material or cutting metal? Our WoodRiver® Carbide Burr Set will handle both jobs with aplomb. You get 20 burrs – 10 double-cut and 10 single-cut in profiles, including balls, pointed cones, rounded cones and cylinders. All the burrs are approximately ⅛" in length, with the cutter length varying with the burr type, and all with 3mm heads (or smaller) and shanks. 3mm shanks? Don't panic! They'll fit ⅛" collets in all the popular rotary and flex shaft machines on the market. We consider this set as a must-have around the shop, because it switches so easily between wood and metal.

- 162416** \$34.99



PFEIL Swiss Made® Brass Carving Mallets

Pfeil Brass Carving Mallets are designed to provide the detail carver with a precise, controllable impact, without rebound on a carving tool while being easy on the wrist and elbow. These well balanced mallets are not for striking, making big cuts, but for lightly tapping to make very controlled, highly detailed cuts.

- 842225** (A) 8½"/700g \$74.99
- 842226** (B) 7½"/450g \$69.99



WoodRiver® 14 oz. Mallet with 1⅞" Head

A lot of mallets have brass heads with wood handles. We chose a slightly different approach for our WoodRiver 14 oz. Mallet and gave it a lightly textured, cool aluminum handle, which provided the heft and feel we were after, along with a kinder-to-your-tool nylon head. Our mallet is not just for carvers but also for anyone who needs to lightly drive a chisel or set a joint. Trim dowels or dovetails, do detail carving, tighten up a chair joint or close a gap in almost any joint with a light tap or a hard smack. Our nylon head can handle both with less stress to your tool's handle and less marring to your wood.

- 162417** \$19.99



A HOCK TOOLS 8" Kitchen Knife Kits

have ⅛"-thick high carbon O1 tool steel blades, the same steel in Hock plane blades that sharpen easily and stay sharp. The Chef's Knife has an 8" cutting edge, overall length is 12⅜". The Carving/Slicing Knife has a 3" cutting edge, overall length is 7⅝". Wash and dry after each use, and never put the knives in the dishwasher. vHandle rivets included, handle material sold separately.

- 160800** (A) chef's knife..... \$71.99
- 160801** (B) carving/slicing knife..... \$51.99



PFEIL Swiss Made® 4-piece Intro Set

We asked Pfeil to put together a tool set to introduce folks to woodcarving – nothing fancy, just the basics. Pfeil's Intro Set is not only a basic woodcarving set but also an introduction to the superb Pfeil carving tools at a phenomenal price. The set contains three Pfeil intermediate carving tools – a 12mm #1 Double Bevel Gouge (05E70), a 10mm #7 Gouge (05E64) and an 8mm #12 V-Parting Tool (05R02), plus a 3⅞" x 7/8" x 3/8" genuine Arkansas stone to keep them sharp. This simple set can be used to do relief carvings, as well as 3-D carvings. Our product manager carved his first spoon with a very similar set over 40 years ago, and he still uses the tools today, along with a few new additions in his tool roll.

- 162469** \$79.99

New Products



RECORD POWER 12-Piece Carving Chisel Set, Educational Booklet & DVD



Record Power has created this incredible woodcarving package of 12 carving tools, plus an educational booklet and DVD for woodworkers and woodcarvers of all skill levels – from the complete novice to the seasoned professional. Each tool in the set is manufactured from spring alloy steel, developed to retain a good cutting edge and for resistance to corrosion. The ergonomically shaped handles are suited for both hand and mallet work, with a substantial tang securing the blade into the handle to ensure strength and durability, locked in place by a ferrule to prevent the handle from splitting. Every set includes an excellent tutorial DVD and

booklet from internationally acclaimed carver and teacher Mike Davies, who has developed a unique and highly successful "carving by numbers" system that is ideal for the novice carving enthusiast. This DVD features his Significant Six carving techniques that will form a solid foundation upon which the aspiring woodcarver's skills can be built. By following Mike's proven system, the viewer will soon be creating a collection of attractive projects and designs using this basic set of 12 tools.

160877 \$139.99

RECORD POWER Carver's 15 oz. Mallet



A good quality carving mallet is essential in order to make carving as comfortable as possible and to assist with control of the cut. Weighing 15 oz., this beech mallet is well-balanced and an ideal general purpose tool suitable for delicate work, as well as for heavier operations such as roughing out. Overall length: 10" with a 2 3/4" (midpoint) head.



160880 \$29.99

RECORD POWER Carver's Vise RPCV130



Record Power's versatile Carver's Vise is lightweight, portable and strong, allowing you to carve almost anytime and anywhere. It can be clamped to any surface, up to 4" thick, and the 4" faceplate/arm assembly can be lowered, raised, swung and rotated 360° to virtually any position. This is the ideal carver's vise for amateurs and professionals alike.



160879 \$79.99

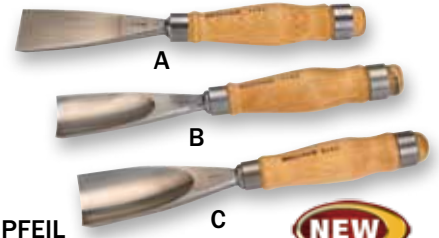

PFEIL Swiss Made® Gouges

Gouges are forged in various sweeps to remove greater or lesser amounts of wood. For instance a #9 sweep gouge will remove a great amount of wood compared to a #1 sweep. These fishtail gouges are Pfeil® Swiss Made® carving tools, which guarantees their reliability, precision and unmatched quality.

- 161284 1/50 #1 50mm (A)..... \$113.89
- 161285 2/50 #2 50mm..... \$120.59
- 161286 5/50 #5 50mm..... \$120.59
- 161287 7/50 #7 50mm (B) \$130.69
- 161288 8/50 #8 50mm..... \$130.69
- 161289 3/60 #3 60mm..... \$137.39
- 161290 8/60 #8 60mm (C) \$150.79

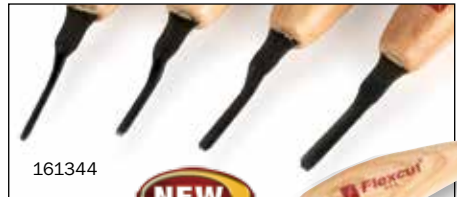

161344



FLEXCUT® Micro Tool Sets

Carving fine details such as hair, feathers, fur, mouths and eyes just got a lot easier. Flexcut's Micro Tool Sets are crafted in the USA from the same tool steel as Flexcut's bigger tools, but they are much smaller – the new standard for micro tools. All tools are easily sharpened on Flexcut's strops and feature handles designed to provide a secure but relaxed grip so necessary when doing detailed work. Handles are 3 7/8" long, with a 1" blade base. Overall tool length is 5 1/2".

- 161344 (A) Sweeps Gouge, 4-pc. \$74.95
- 161345 (B) Shallow U-Gouge, 4-pc. \$76.50
- 161346 (C) Deep U-Gouge, 4-pc. \$74.95
- 161347 (D) 45° V-Parting, 4-pc. \$74.95
- 161348 (E) 60° V-Parting, 4-pc. \$74.95
- 161349 (F) 90° V-Parting, 4-pc. \$74.95



161350

6-Piece Set contains one each of a 1.5mm Chisel, Skew, Sweep, Deep-U, 45° and 90° V-tools.

161350 \$111.99

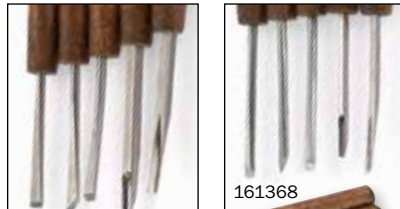

161369

161368



161371



RAMELSON Micro Carving Tool Sets

Ramelson Micro Carving Tools are made in the USA. Each tool is forged, tempered to HRC58 for a durable edge, and sharpened for use right out of the pouch. Tools of this size and quality are an absolute must if you're carving detail into wood or simply doing very small carvings. Tools are approximately 5 1/2" in overall length, with a 4 7/8" round hardwood handle, lightly finished to protect the handle and ensure a good grip while carving. Set includes a Bent V, Bent Single Bevel Chisel, Straight Double Bevel Chisel, Straight Double Bevel Skew Chisel and a Straight U Gouge.

- 161371 1.5mm set \$41.99
- 161368 2.0mm set \$41.99
- 161369 3.0mm set \$41.99



PFEIL Swiss Made® Drayer Gouges

Pfeil Drayer Gouges aren't really gouges at all, they are heavy-duty, double bevel skew chisels that got their name from a teacher at the Brienz Woodcarving School who requested that Pfeil make them. These tools are intended to be struck with a mallet and are capable of removing large chunks of wood with aplomb. Drayer Gouges come in four sizes listed below. Blades are electronically hardened alloy chrome-vanadium steel, with round, double hooped European hardwood handles. Overall approximate length is 11 1/4", with a 4 3/4" blade.

- 161291 50mm (1.97") \$110.69
- 161292 60mm (2.36") \$123.69
- 161308 70mm (2.75") \$132.89
- 161293 80mm (3.149") \$141.59

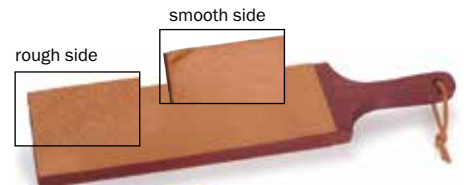

FLEXCUT® Paddle Strop PW16



The Flexcut Dual Sided Paddle Strop is a whopping 10" x 3"! That's enough stropping area for knives, plane blades, drawknives, kitchen cutlery and anything else you think needs a razor edge. The rough leather surface is used in conjunction with Flexcut Gold Polishing Compound to remove hardened steel. Turn the paddle over to the smooth leather surface for a high sheen, razor-sharp finish. Includes a 1 oz. bar of Flexcut Gold Polishing Compound; when you need more, we have it. Overall length of the strop including the handle is 14 3/4".

866263 \$39.95





852094

**SawStop®
3 HP Professional Cabinet Saw
With 30" Premium Fence System
PCS31230-PFA30***

The SawStop Professional Cabinet Saws are engineered to exceed the unique demands of the avid hobbyist. We offer the Professional Cabinet Saws, with peerless fit and finish, in two power options to match and optimize any home shop. SawStop delivers the performance you need with the peace of mind only SawStop's patented safety system can provide. The SawStop table saw's unique brake design detects hand or finger contact with the saw blade within milliseconds, instantly stopping and retracting the blade, helping to avoid serious injury. In addition to the groundbreaking safety features, SawStop manufactures one of the most precise saws on the market.

*\$250 freight charge applies to this item.

846918 PCS175-PFA30*\$2,299.00

852094 PCS31230-PFA30*\$2,729.00

**SawStop®
3 HP Professional Cabinet Saw
With 36" Professional T-Glide
Fence System
PCS31230-TGP236***

Includes: 36" Professional T-Glide Fence, Table Board, Legs and Dust Collection Blade Guard.

*\$250 freight charge applies to this item.

847462\$2,899.00

SawStop Professional Saws & Accessories



847463/846920

**SawStop®
3 HP Professional Cabinet Saw
With 52" Professional T-Glide
Fence System
PCS31230-TGP252***

Includes: 52" Professional T-Glide Fence, Table Board, Legs and Dust Collection Blade Guard.

*\$250 freight charge applies to this item.

847463\$2,999.00

**SawStop®
1 3/4 HP Professional Cabinet Saw
With 52" Professional T-Glide
Fence System
PCS175-TGP252***

Includes: 52" Professional T-Glide Fence, Table Board, Legs and Micro Blade Guard.

*\$250 freight charge applies to this item.

846920\$2,569.00

**SawStop®
1 3/4 HP Professional Cabinet Saw
With 36" Professional T-Glide
Fence System
PCS175-TGP236***

Includes: 36" Professional T-Glide Fence, Table Board, Legs and Micro Blade Guard.

*\$250 freight charge applies to this item.

846919\$2,469.00

**SawStop®
Professional
Cabinet Saw
Mobile Base**

Specifically designed for SawStop Professional Cabinet Saws – 3 HP and 1 3/4 HP versions, This unit is so rugged that it supports the entire table and requires no extension piece – even for the 52" extension table.

843878\$199.00



**SawStop®
Overarm
Dust Collection
Assembly**

The Overarm Dust Collection Assembly provides a simple and unobtrusive way to remove dust by connecting directly to SawStop's dust-collection blade guard. This unit is compatible with ALL SawStop saws, except CNS-SFA, and fits ALL SawStop T-Glide Fence Rail Systems. This unit requires Dust Collection Panel (842962), and Dust Collection Blade Guard (846911) purchased separately.

846909\$199.00

846911 DC blade guard\$139.00

842962 DC panel\$49.00



**SawStop® 10" Brake Cartridge –
ICS, PCS & CNS
Compatible**

Current SawStop models use cartridges with blue tinted plastic cases. Older models use a clear case. Please call SawStop for details.

839901 (shown)\$69.00

839902 8" dado brake cart. for ICS, PCS, PNS\$89.00



**SawStop® Standard Zero-Clearance
Lock-Down Insert –
ICS, PCS & CNS Compatible**

This insert can be used on all SawStop Table Saws using standard 10" saw blades. Precision machined from a high-quality, ultra strong phenolic core material that is covered on top and bottom with a low-friction, wear-resistant melamine surface. The positive locking latch allows for tool-free operation.

843879 Standard\$39.00

843880 Dado\$39.00



**For A More Complete Selection of
SawStop Models & Accessories
See Your Local Woodcraft Store,
or Visit woodcraft.com,**

capacity. To save space, you can flush mount the sliding table with the saw's front rail, keeping a full 36" crosscut capacity. The 43"-long aluminum fence can expand past 58". A single-knob angle adjustment on an oversized miter gauge will adjust to 60°. The fence can be positioned anywhere along the length of the sliding table and its proximity to the blade easily adjusted. Sliding table comes with two large flip-stops, scale and magnified lenses for accurate, repeatable cuts. *Shipping weight: 85 lbs.

861677\$999.00

*Additional \$75 Freight Charge for this item.



856291

**SawStop® Industrial Cabinet Saws
With 52" Industrial T-Glide Fence System**

The SawStop® Industrial Cabinet Saw is the definition of industrial grade. It is the heaviest, most powerful and highest quality 10" cabinet saw available. The configurations with a 52" Industrial T-Glide Fence Assembly offer the durability, versatility, and the peace of mind only SawStop's patented safety system can provide.

Features:

- SawStop's patented safety system
- Riving knife reduces the risk of kickback
- Tool-free quick-change blade guard mount
- Diagnostic system ensures the saw is ready to respond

- Dust-Collection Blade Guard
- 52" Industrial T-Glide Fence System

Includes: 52" Industrial T-Glide Fence, Table Board, Legs and Dust-Collection Blade Guard.

*Shipping weight: 802 lbs.

856291 3 HP, 1Ph Industrial Cabinet Saw\$3,999.00

856293 5 HP, 1Ph Industrial Cabinet Saw\$4,399.00

856295 5 HP, 3Ph Industrial Cabinet Saw\$4,399.00

856296 5 HP, 3Ph Industrial Cabinet Saw\$4,399.00

856297 5 HP, 3Ph Industrial Cabinet Saw\$4,399.00

856298 5 HP, 3Ph Industrial Cabinet Saw\$4,399.00

856299 5 HP, 3Ph Industrial Cabinet Saw\$4,399.00

856290 3 HP, 1Ph Industrial Cabinet Saw\$3,899.00

856292 5 HP, 1Ph Industrial Cabinet Saw\$4,299.00

856294 5 HP, 3Ph Industrial Cabinet Saw\$4,299.00

856295 5 HP, 3Ph Industrial Cabinet Saw\$4,299.00

856296 5 HP, 3Ph Industrial Cabinet Saw\$4,299.00

856297 5 HP, 3Ph Industrial Cabinet Saw\$4,299.00

856298 5 HP, 3Ph Industrial Cabinet Saw\$4,299.00

856299 5 HP, 3Ph Industrial Cabinet Saw\$4,299.00

856290 3 HP, 1Ph Industrial Cabinet Saw\$3,899.00

856292 5 HP, 1Ph Industrial Cabinet Saw\$4,299.00

856294 5 HP, 3Ph Industrial Cabinet Saw\$4,299.00

856295 5 HP, 3Ph Industrial Cabinet Saw\$4,299.00

856296 5 HP, 3Ph Industrial Cabinet Saw\$4,299.00

856297 5 HP, 3Ph Industrial Cabinet Saw\$4,299.00

856298 5 HP, 3Ph Industrial Cabinet Saw\$4,299.00

856299 5 HP, 3Ph Industrial Cabinet Saw\$4,299.00

856290 3 HP, 1Ph Industrial Cabinet Saw\$3,899.00

856292 5 HP, 1Ph Industrial Cabinet Saw\$4,299.00

856294 5 HP, 3Ph Industrial Cabinet Saw\$4,299.00

856295 5 HP, 3Ph Industrial Cabinet Saw\$4,299.00

856296 5 HP, 3Ph Industrial Cabinet Saw\$4,299.00

856297 5 HP, 3Ph Industrial Cabinet Saw\$4,299.00

856298 5 HP, 3Ph Industrial Cabinet Saw\$4,299.00

856299 5 HP, 3Ph Industrial Cabinet Saw\$4,299.00

856290 3 HP, 1Ph Industrial Cabinet Saw\$3,899.00

856292 5 HP, 1Ph Industrial Cabinet Saw\$4,299.00

856294 5 HP, 3Ph Industrial Cabinet Saw\$4,299.00

856295 5 HP, 3Ph Industrial Cabinet Saw\$4,299.00

**SawStop® Sliding Crosscut Table
TSA-SA48**

The TSA-SA48 Sliding Table is made of anodized T-6 aircraft-grade extruded aluminum and is engineered to fit all existing SawStop saws. **Special Note:** This Sliding Crosscut Table will require users to cut the front and rear guide rail. This is a simple task that any local machine shop will be able to do for a minimal fee. With multiple bearings, this slider is smooth as silk under the heaviest of loads and is micro-adjustable for smoothness and parallelism to the blade. The sliding table is 47 3/4" deep with a massive 55" travel, giving the user 48" of crosscut





See Your
Woodcraft Store,
or Woodcraft.com,
For More
SawStop Models
& Accessories

SawStop® Contractor Saw With 30" Aluminum Extrusion Fence System

Model CNS175-SFA30*
Includes: 1¾ HP Saw with stand, 30" Aluminum Extrusion Fence System, 10" 40-tooth combination blade, two stamped wings, blade guard assembly, miter gauge, riving knife, blade wrenches and owner's manual.

- Specifications:**
- CNS175-SFA30: includes aluminum extrusion fence & 30" rails
 - Motor: 1¾ HP, 110-120V, 15A
 - *User-configurable to 220-240V, 7.5A
 - Footprint: 25¾ W, x 27" D
 - Overall dimensions: 58" W x 45" D x 34¾" H

- Cast iron table: 20" W x 27" D
 - Extension wing: 12" W x 27" D
 - Blade: 10" diameter, 5/8" arbor
 - Blade tilt: left
 - Maximum depth of cut: 3¼"
 - Dado diameter: 8"
 - Dado max. width: 1¾"
 - Dust-collection port: 4" diameter
 - Insert: zero-clearance lock-down insert
 - Blade guard: polycarbonate, thin profile
 - Riving knife/splitter: 2mm thick
- *\$150 freight charge applies to this item.
840937*\$1,599.00

CNS Contractor Saw Accessories

CNS Contractor Saw Mobile Base
Features a fully-welded ¼" rigid steel construction and black powder coat finish.
840932 \$160.00

CNS Contractor Saw Cast-Iron Wing
A cast-iron wing provides a more stable, accurate surface and is precision ground to .0001".
838767 \$100.00

CNS Contractor Saw 30" Outfeed Table
Constructed of smooth ¾" polyurethane coated MDF with machined miter gauge slots and all steel hardware, including sturdy black powder-coated legs with adjustable feet.
840934\$99.00



SawStop® Contractor Saw With 36" Professional T-Glide Fence System
Model CNS175-TGP36*
*\$150 freight charge applies to this item.
840938* \$1,799.00

SawStop® Contractor Saw With 52" Professional T-Glide Fence System
Model CNS175-TGP52*
*\$150 freight charge applies to this item.
840939*\$1,899.00

CNS Contractor Saw Dust Control Panel
A versatile dust-collection accessory that fits 2½" and 4" dust-collection systems and is used in conjunction with the Overarm Dust Collection Assembly (846909).
842962\$49.00

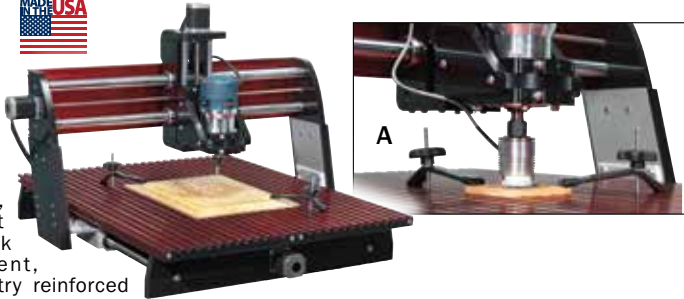

Next Wave Automation Shark HD4®

The all-new CNC Shark HD4®, now with Color Pendant Controller and CNC Shark Exclusive Auto Alignment, features a heavy-duty gantry reinforced with plate aluminum and a rigid interlocking aluminum table. It has anti-backlash, wear-compensated high precision lead screws on all 3 axes and is built to handle large 2¼ HP routers or the water-cooled spindle from Next Wave Automation. To accommodate even greater torque levels, the CNC Shark HD4® features adjustable bearings to give more stability during heavy cutting. It is perfect for carving and machining a large variety of projects made from wood, soft metals or plastics. Includes: CNC Shark HD4®, VCarve Desktop V8 Design software,

Vector Art 3D Sampler Pack, and CNC Shark control software. Made in the USA.

- Features:**
- Auto Edge & Rotational Sensing technology
 - Virtual Zero exclusive software
 - Touch-Screen Color Graphic Pendant Controlled software package
 - X & Y Homing Capability
 - Table dimensions: 28" W x 36" D
 - XYZ travel: 25" x 25" x 7"
 - Overall dimensions: 36¼" W x 36" L x 24½" H

NOTE: A minimum 15% Restocking Fee applies to the return of CNC machines - Please contact Customer Service for details.

work with the included VCarve Desktop V8 Design software on a PC computer with USB 2.0 port, save your program onto a USB flash drive, plug it into the Pendant, select your file, and hit the run button. PC & USB flash drive not included.

- Specifications:**
- Table dimensions: 12" W x 18" D
 - XYZ travel: 12" x 13" x 3"
 - Overall dimensions: 19½" W x 20½" L x 18" H
 - Aluminum interlocking Slotted Table Track for highly customizable clamping
 - Includes VCarve Desktop V8 Design software
 - Vector Art 3D Sampler Pack
 - Color Touch Screen Pendant Controller System
 - Currently not compatible with the Touch Probe (upgrade coming soon)

- Anti-backlash, wear-compensated direct drive
- lead screws on all axes
- Interlocking rigid aluminum table with virtually Unlimited clamp positioning
- Automatic on/off software control of router or spindle system
- Requires a PC computer with USB 2.0 port (not included)
- Requires a USB Flash Drive (not included)
- One-year warranty on parts and labor

Fully compatible with the following routers (sold separately): Bosch 1617 and 1618, Porter-Cable 890 Series, Porter-Cable 690 Series (6902VS must be manually started) and DeWalt 610, 616, 618 series routers

- 162343\$3,999.99
161352 (A) Laser Module (see page 5)\$799.99

For A Complete List Of Shark HD Accessories, See Your Local Woodcraft Store, or visit woodcraft.com

WHITESIDE CNC Router Bits

- | | | |
|-----------|-------------------------------|----------|
| 866162 | 3/32" x 45° engraving..... | \$32.00 |
| 161278* | 1/16" ball nose..... | \$53.99 |
| 161279**† | 1/8" ball nose..... | \$53.99 |
| 161280† | 3/16" ball round nose..... | \$23.80 |
| 161281† | 1/4" ball round nose..... | \$25.99 |
| 818081* | 1/4" dia. upcut spiral..... | \$19.99 |
| 837620 | 5/8" point carving liner..... | \$27.00 |
| 24871* | 90° V-groove..... | \$22.99 |
| 24881* | 60° V-groove..... | \$20.80 |
| 161282 | ball nose set, 3-pc. (†)..... | \$99.99 |
| 161283 | starter set, 5-pc. (*)..... | \$159.99 |

- Includes 3/8" V-Router Bit
 - Includes 2 Hold-Down Clamps
 - Requires a PC Computer w/USB 2.0 port (not included)
 - Requires a DeWalt, Porter-Cable, or similar style Palm Router (sold separately)
 - Ships fully assembled.
 - Made in USA
- 160958\$1,599.99
161666 Bosch rtr. motor mnt. bracket \$35.00
161352 Laser Module (see page 5) \$799.99



Next Wave Automation CNC Piranha FX

The compact 12" x 18" table makes the CNC Piranha perfect for smaller-scale projects like carvings, plaques, ornamental boxes and precision parts machined from wood, soft metals, or plastics. With its 3D carving capability, including a 3D models library, you can carve expensive corbels, cut intricate inlays or engravings. Design your

Router motor sold separately





SawStop® Jobsite Saw With Mobile Cart

- Unites SawStop Safety, Innovation, Precision And Compact Portability
- Simple, Intuitive Action Extends The Mobile Cart For Use And Collapses The Cart For Transport
- Motor Configuration: 15A, 120 VAC, 60 HZ, Universal Motor
- Weight: 79 lbs., 108 lbs. with cart
- Blade Diameter: 10"
- Depth Of Cut: 3 1/8" Max At 0°, 2 1/8" at 45°
- Dado Diameter: 8"
- Max Rip, Right Of The Blade: 25 1/2"
- Table Dimensions: 43 3/8" W x 22 5/8" D

862994* Jobsite Saw with Cart.....**\$1,299.00**
862995 Jobsite Saw Standard Insert.....**\$29.00**
862996 Jobsite Saw Dado Insert.....**\$29.00**
 *\$100 freight shipping charge applies to 862994
 See Your Local Store, or woodcraft.com For Availability.

Next Wave Automation Piranha XL® CNC



The All-New CNC Piranha XL® features an extra-large table, which makes it perfect for projects like carvings, plaques, ornamental boxes and precision parts machined from wood, soft metals, or plastics. Just design your work with the included VCarve Desktop V8 Design software on a PC computer with USB 2.0 port (not included). Then simply save the program directly to a USB flash drive (not included), plug it into the Pendant, select your file, and hit the run button. Includes: Piranha XL CNC, VCarve Desktop V8 Design Software, Vector Art 3D Sampler Pack, Color Touch Screen Pendant Controller System, V-Router Bit, Instruction Manual and Two Hold-Down Clamps. Made in USA.

Features:

- Auto Edge & Rotational Sensing technology
- Virtual Zero exclusive software
- Touch Screen Color Graphic Pendant Controlled software package
- X & Y Homing Capability
- Table dimensions: 12" W x 30" D
- XYZ travel: 12" x 24" x 4"
- Overall dimensions: 19 1/2" W x 30 1/2" L x 24" H
- Aluminum interlocking slotted table track
- Requires a PC computer with USB 2.0 port (not included)

Next Wave Automation CNC Machines Laser Module

This interchangeable Laser Module mounts in the collet of the palm router and will enable you to create detailed photographic engravings, images and lettering. Includes: Laser Module, ribbon cable, power supply and protective glasses.

NOTE: Compatible with either a Piranha CNC Machine and PC Computer with USB 2.0 port (not included); or a Shark HD3 CNC with required Laser Interface 161649 (not included). Made in USA.

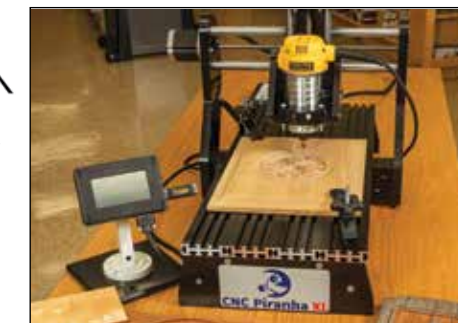

- Requires a USB Flash Drive (not included)
- Requires a DeWalt, Porter-Cable, or similar style Palm Router (sold separately)
- Requires a Bosch Motor Mounting Bracket (161666) if Bosch motor is being used
- Ships fully assembled.

NOTE: A minimum 15% Restocking Fee applies to the return of CNC machines – Please contact Customer Service for details.

162342**\$2,499.99**
161666 Bosch motor mount bracket..... **\$35.00**
161352 (below) **\$799.99**



SPECIAL NOTES: May require a free software update for use with older Next Wave Automation CNC machines. When used with Shark HD3 CNC Machine, requires Laser Interface (161649).
161352 **\$799.99**

161352 **\$799.99**



Helping You Make Wood Work®



FESTOOL® ETS EC Brushless EQ Sanders

Equipped with EC-TEC (r) Brushless Motors, these low-profile, long-life, and low-vibration sanders can run all day with multiple shifts. The ETS EC 125 and ETS EC 150 are available in a fine 3mm stroke. The ETS EC 150 can also be purchased with a broader 5mm stroke. These sanders offer the performance of an air sander without the expense and bulk of an air system. These ETS EC Sanders are equipped with innovative features, such as Multi-Jetstream Dust Extraction, Extraction Connection Signal, Electronic Active Vibration Stop, Carbide-Tipped Sanding Brakes and much more, that make them the ultimate high-demand sanding tools. Each sander includes: StickFix Sanding Pad, Pad Wrench, Plug It Cable, and SYS 2 T-LOC Systainer.

Specifications:

- Power Consumption:
- 400 watts (3.3 Amps, 120 VAC)
- Motor Type: EC –TEC Brushless Motor
- Pad Size: 6" (150mm) or 5" (125mm)/571897
- Speed: 6,000 – 10,000 RPM
- Sanding Stroke: 1/8" (3.0mm) or 3/16" (5.0mm)/571892
- Dust Extraction Port: 27mm
- Weight: 2.6 lbs. (1.2 kg)
- Systainer: SYS 2

571880 (A) ETS EC 150/3 EQ Sander.. **\$485.00**
571892 (B) ETS EC 150/5 EQ Sander.. **\$485.00**
571897 (C) ETS EC125/3 EQ Sander... **\$385.00**

Pads & Abrasives For 5" & 6" Festool Sanders

Rubin 2

Durable abrasive for aggressive sanding of bare wood; great for mild to medium stock removal and finish prep.



	Size	Grit	Qty./Pack	
499094	5"	60	50	\$32.00
499095	5"	80	50	\$32.00
499096	5"	100	50	\$32.00
499097	5"	120	50	\$32.00
499099	5"	180	50	\$32.00
499117	6"	40	50	\$36.00
499118	6"	60	50	\$36.00
499119	6"	80	50	\$36.00
499121	6"	120	50	\$36.00
499123	6"	180	50	\$36.00

Replacement Pads



	Size	Grit	Qty./Pkg.	
492280	5"	Soft	1	\$40.00
492282	5"	Super Soft	1	\$38.00
498987	6"	Soft	1	\$47.00
498988	6"	Hard	1	\$44.00

Technical Questions?

Call 1-800-535-4486
 For FREE help, and advice!





FESTOOL® Random Orbit Sanders

- Turbo Dust Extraction
 - Pad brake
 - Variable Speed
 - StickFix Hook & Loop Pad System
- Model ETS 150/3 EQ, 6" Sander** with NEW Fusion Tec design has a 1/8" stroke, 2.5 Amp, 6,000 to 10,500 OPM, with a T-LOC Systerainer storage container, 4 lbs. net weight.
- 571903 (A)** \$360.00
571916 ETS 150/5 R.O. Sander.... with Fusion-Tec....\$360.00

Model RTS 400 REQ. 5/64" stroke, rectangular pad of 3 3/32" x 5 1/4" and 2.0 amp variable-speed motor, 6,000 to 14,000 OPM. Includes: Pad Protector, Clean-Tec Hose Quick-Change Retrofit Dust Port Assembly, and T-LOC Systerainer storage container. 2.4 lbs.

201221 **NEW!** \$260.00

Model DTS 400 REQ. 2.0 Amps, 6,000-14,000 OPM, 2.4 lbs. Triangular pad is 4" x 6". Includes: hook & loop pad and a T-LOC Systerainer storage container.

201228(C) \$260.00

FESTOOL® SysLite II LED

Work Lamp
 Robust construction with a shock-resistant body, LEDs emit 50% more light with 20% longer run times. Higher capacity internal battery and an integrated emergency lighting function. This lamp can be used with external Festool batteries or plugged directly into a power source.

- 500723** \$198.00
499814 (A) SysLite Adapter magnetic swivel base ...\$76.00

Lithium Ion Batteries

- 500530 15V, 5.2 Ah** \$55.00
500531 18V, 5.2 Ah \$65.00



FESTOOL® CT Wings

Utilizing suction from a CT Dust Extractor, the CT Wings provide an additional support for mounting long items to a wall – like molding or for holding a straightedge or level in place for layout marks. With 16 adjustable "wings," CT Wings adjust and conform to molding and other stock quickly while providing a tacky grip surface to minimize movement. A bypass valve allows for quick and easy release and reset without going back to the extractor. Maximum material thickness is 2" (50mm), and maximum load is 6.6 lbs. Includes one unit.

500312 \$48.00

FESTOOL® Rotex Dual Mode Sanders

- Dual-mode random orbital action
 - Turbo Dust Extraction
 - Pad brake
 - Variable Speed
 - StickFix Hook & Loop Pad System
- Includes: Edge protector, removable dust channel & T-LOC Systerainer.

Model RO 150 FEQ 6" Dual Mode Sander with with NEW Multi-Jetstream design has a 3/16" stroke, 6 Amp, 320-660 RPM rotary motion speed, 3,300-6,800 OPM eccentric motion speed, 5 lbs.

571810 (A) \$595.00

Model RO 125, 5" Dual Mode Sander has a 9/64" stroke, 4.2 Amps, 300-600 RPM rotary motion speed, 3,000-6,000 OPM eccentric motion speed, 4.4 lbs.

571782 (B) \$490.00

woodcraft.com has a complete selection of FESTOOL Stickfix Sandpaper.

Model RO 90 Multi-Mode Rotex Sander

The versatile RO 90 DX easily switches to three different sanding modes - aggressive sanding, finish sanding or delta sanding. Switch from circular pad to delta-shaped pad in seconds. with no tools required. 1/2 horsepower. Includes: New SYS 2 T-LOC Systerainer, StickFix Soft Round Sanding Pad, StickFix V93 Delta Sanding Pad, Edge Protector, Plug-It Power Cord, and instruction manual.

571823 \$440.00

FESTOOL® Routers

- Superior Dust Extraction
- Powerful
- Multi-Material Speed Control
- Tool-Less Inserts

Model MFK 700 EQ
574368 \$535.00

Model SKU	MFK 700 EQ 574368	OF 1010 EQ 574691	OF 1400 574692	EQ 2200 EB 574689
Router Type	Trim*	Plunge	Plunge	Plunge
Watts/Amps	720W/6A	1,010W/8.5A	1,400W/11.7A	2,200W/18A
RPM	10,000-26,000	10,000-23,000	10,000-22,500	10,000-22,500
Depth adjustment	Micro Adjust- 1/256"	2 1/8"	2 3/4"	3 5/32"
Collet, Included	1/4" and 8mm	1/4" and 8mm	1/4", 1/2" and 8mm	1/2"
Weight	4.2 lbs.	5.94 lbs.	9.9 lbs.	17.2 lbs.
Chip Catcher	N/A	Yes	Yes	Yes
Dust Extraction Hood	Yes	Yes	Yes	Yes
Guide Stop	N/A	Yes	No	No
U.S. Guide Bush. Adapt.	N/A	Yes	Yes	Yes
Column stroke	9/16"	N/A	N/A	N/A
Max bit diameter	1" (26mm)	N/A	N/A	N/A
Systerainer	SYS 2 T-LOC	SYS 3 T-LOC	SYS 4 T-LOC	SYS 5 T-LOC

*Includes Vertical Base, 1.5" Horizontal Base & Feeler Bearing Set

FESTOOL® CT SYS Portable Dust Extractor

The CT SYS is portable, compact and loaded with features such as, tool-triggered operation, high performance suction, and Systerainer storage/transportation integration. The CT SYS provides 106 CFM at only 67 decibels (dB), and weighs just over 15 lbs., it can easily go wherever you need it. Integrated hose storage and common use cleanup tools pair well with the shoulder strap, 16' power cord and nearly 10' hose. Includes: CT SYS, Shoulder Strap, HEPA Filter, Disposable Filter Bag, 1 1/16" x 9.8' Hose, Upholstery Brush, Crevice Nozzle and Owner's Manual.

- Specifications:**
- Power: 1,000 Watt, 8.3 amp motor
 - Container Capacity: 1.2 gal.



- Filter Bag Capacity: .9 gal.
- Max. Suction Capacity: 106 CFM
- Max. Vacuum: 80" static water lift
- Power Cord: 16'
- Size (D x W x H): 15 9/16" x 11 5/8" x 10 5/8"
- Weight: 15.2 lbs.
- Sound Level: 67 dB

584174 \$380.00
500438 repl. bags (5) \$21.00

FESTOOL® Dust Extractors

- Automatic Tool Start
- Oversized wheels

	CT Mini 574786	CT 26 E 583492	CT 36 E 583493	CT 48 584084
Filters	HEPA	HEPA	HEPA	HEPA
Antistatic Suction Hose	1 1/16" x 11.5' (27mm x 3.5 m)	1 1/16" x 11.5' (27mm x 3.5 m)	1 1/16" x 11.5' (27mm x 3.5 m)	1 1/16" x 11.5' (27mm x 3.5 m)
Container Capacity	2.6 gal. (10 L)	6.9 gal. (26 L)	9.5 gal. (36 L)	12.7 gal. (48 L)
Filter Bag Capacity	2 gal. (7.5 L)	6.3 gal. (24 L)	8.9 gal. (34 L)	12.2 gal. (46 L)
Depth x Width x Height	17.5" x 13.5" x 16.5"	24.8" x 14.4" x 21.25"	24.8" x 14.4" x 23.4"	26.1" x 15.4" x 27"
Weight	21 lbs.	28.9 lbs.	29.8 lbs.	35.9 lbs
Noise (low setting)	62 dB	62 dB	62 dB	62 dB
(max. setting)	72 dB	72 dB	72 dB	72 dB
Max. Suction	99 CFM	137 CFM	137 CFM	137 CFM
Power Consumption	400-1,200 watts / 3.3-10 amps, 120V	350-1,200 watts / 2.9-10 amps, 120V	350-1,200 watts / 2.9-10 amps, 120V	350-1,200 watts / 2.9-10 amps, 120V
Integrated SYS-dock	Yes	Yes	Yes	Yes
Adjustable Suction	Yes	Yes	Yes	Yes
Locking Brake	Yes	Yes	Yes	Yes
Integrated Hose Garage	Yes	Yes	Yes	Yes
HEPA Filtration	Yes	Yes	Yes	Yes

- 574786** CT Mini \$510.00
574787 CT Midi (nt. shwn.) \$560.00
583492 CT 26 E \$700.00
583493 CT 36 E \$756.00
584084 CT 48 \$795.00
498410 CT Mini filter bags (5) \$30.00
498411 CT Midi filter bags (5) \$36.00
452970 CT 22 filter bags (5) \$40.00
452971 CT 33 filter bags (5) \$46.00
496187 CT 26 filter bags (5) \$40.00
496186 CT 36 filter bags (5) \$46.00
497539 CT 48 filter bags (5) \$50.00



FESTOOL® Domino® Joiner System DF500Q

The Domino Joiner cuts "rectangular", domino shaped slots to accept the pre-fabricated, solid Beech Domino tenons.

- Precise positioning and accurate mortising
- Powerful 420 watt motor – 24,300 RPM
- Fully adjustable large pivoting fence system
- Dust extraction
- 5 different mortising depths
- For material thickness of 3/16" to 1 3/16"

System includes DF 500 Q Domino, D5 Cutter, Support Bracket, Wrench and custom fitted T-LOC Systainer 2. Dominoes sold separately.

574332 DFQ 500 Q system \$910.00

Domino Cutter And Tenon Assortment T-LOC Systainer

Systainer includes: D10, D8, D6, D5 & D4 Cutters; 225-5mm x 30mm, 150-6mm x 40mm, 100-8mm x 40mm, 75-8mm x 50mm, 60-10mm x 50mm, and 450-4 x 20mm dominoes.

498899 \$316.00

FESTOOL®



FESTOOL® Domino XL DF 700 Joiner

Bigger and stronger than the original, there is no job too big for the Domino XL. With an expanded range of thicker, longer tenons, you can quickly and precisely join massive slabs, doors, and gates or construct the most durable of tables and just about any larger scale project you can imagine. This tool can create mortises up to 9/16" (14mm) thick and 5 9/16" (140mm) long. Domino XL DF 700 Joiner includes: Domino XL DF 700, 12mm Cutter, Support Bracket, Plug-It Power Cord, Wrench and T-LOC Systainer #5 storage container.

Specifications:

- Motor: 720 watts
- RPM: 21,000 RPM
- Routing Depth: 15-70mm
- Routing Width: 16 1/2mm + Dia. of Cutter
- Cutters: 8mm, 10mm, 12mm, 14mm (12 included)
- Weight: 11.6 lbs.

574422 \$1,335.00

FESTOOL® Domino XL DF 700 Joiner Set

Domino XL DF 700 Joiner Set includes: Domino XL DF 700, 12mm Cutter, Support Bracket, Trim Stop, Cross Stop, Plug-It Power Cord, Wrench and T-LOC Systainer #5 storage container.

574447 \$1,430.00



Domino Cross Stop Set

For hole spacings between 4" (100mm) and 8" (205mm).
498590 D/S \$74.00



Domino Trim Stop

For repeatable mortising of spindles, narrow rails, or other materials from 22mm (7/8") to 70mm (2 3/4") wide.
493487 D/S \$74.00



FESTOOL Domino Joiner Set

Best Value – Save \$68 when you combine the Domino Joiner with the Cross Stop and Trim Stop.
574432 DF 500 Q Set \$990.00

Replacement Domino Cutters

493493	D10 (10mm)	\$44.00
493492	D8 (8mm)	\$44.00
493491	D6 (6mm)	\$42.00
493490	D5 (5mm)	\$40.00
495663	D4 (4mm)	\$40.00

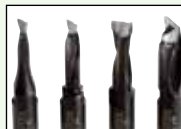

D5 D6 D8 D10

Domino Tenons

	Size	Pieces	
495661	4mm x 20mm	450	\$24.00
493296	5mm x 30mm	1,800	\$94.00
493297	6mm x 40mm	1,140	\$94.00
493298	8mm x 40mm	780	\$94.00
493299	8mm x 50mm	600	\$94.00
493300	10mm x 50mm	510	\$94.00

D/S = Item drop ships direct from manufacturer.

FESTOOL® Domino Cutter And Tenon Assortment Systainer

8mm & 10mm Mix

This kit is perfectly suited for a wide range of medium to large scale projects. Includes assorted Domino tenons: 49 – 8mm x 50mm, 38 – 8mm x 80mm, 36 – 8mm x 100mm, 82 – 10mm x 50mm, 52 – 10mm x 80mm, 53 – 10mm x 100mm, plus two Domino XL Cutters, sizes 8mm and 10mm.

498204 \$316.00



FESTOOL® Domino Cutter And Tenon Assortment Systainer

12mm & 14mm Mix

This kit is perfectly suited for your biggest, most demanding projects. Includes assorted Domino tenons: 41 – 12mm x 100mm, 40 – 12mm x 140mm, 16 – 14mm x 100mm, 32 – 14mm x 140mm, plus one 14mm Domino XL Cutter.

498205 \$288.00



FESTOOL® Domino XL Cutters

Durable, carbide-tipped cutters quickly and precisely carve out clean and consistently sized mortises, ensuring a perfect fit and precise joint placement.

497868	Domino XL 8mm Cutter	\$58.00
497869	Domino XL 10mm Cutter	\$60.00
497870	Domino XL 12mm Cutter	\$62.00
497871	Domino XL 14mm Cutter	\$64.00

FESTOOL® Domino XL Tenon Assortment

See your local Woodcraft Store or woodcraft.com for a complete selection of Domino XL tenons.



Model TS 55 REQ

FESTOOL® Plunge-Cut Saws

Get the accuracy of a panel saw, table saw, sliding miter saw or radial-arm saw in a compact package that delivers precise cuts in any environment.

Both models include: Splinterguard and Limit stop.

Model 55 REQ Imperial

574683	\$660.00
496305	standard blade, 12T, ATB	\$52.00
495377	lam./veneer blade, 48T, ATB	\$80.00
496304	universal blade, 28T, ATB	\$58.00
496309	lam. floor/Corian® blade, 48T	\$90.00

Model 75 EQ Imperial

574684	\$780.00
495380	universal blade, 36T, ATB	\$90.00
495381	fine-tooth blade, 52T, ATB	\$130.00
491473	splinter guards (5)	\$24.00

Specifications:	TS 55 REQ	TS 75 EQ
Watts/Amps:	1,200W/10A	1,600W/13A
RPM:	2,000-5,200	1,350-3,550
Dust Extraction:	YES	YES
Cut Depth:	1 15/16"	2 3/4"
Cut Depth at 45°:	1 7/16"	2 1/8"
Cut Depth w/Rail:	2 1/8"	2 15/16"
Weight:	9.92 lbs.	13.6 lbs.
Blade Diameter:	6 1/4"	8 1/4"
Blade Arbor:	.787 (20mm)	1.101 (30mm)
Bevel Cuts:	0°-45°	0°-45°
Guide Rail:	55"	75"
Carbide Blade:	48 T	36T
Systainer:	SYS 4 T-LOC	SYS 5 T-LOC

FESTOOL® FS Guide System

For use with any Festool saw or router.

491498	55" guide rail	\$136.00
491937	106" guide rail	\$340.00
495207	replac. 55" splinter guard	\$23.00
495209	replac. 197" splinter guard	\$44.00
482107	1 guide rail connector (2 rcmnd.)	\$19.00
489570	clamps (2), 4 1/16" capacity	\$44.00

Guide Rail Accessory Kit. Includes: angle unit; limit stop; 55" splinter guard; deflector; 2 guide rail connectors; 2 clamps; Systainer 1 storage container.
497657 \$230.00



FESTOOL® Parallel Guide Extension System

The Festool parallel guide set, allows you to make accurate rips and crosscuts ranging from 1/16" to 2 1/2" with your Festool guide rail and TS plunge cut saw. The parallel guides have movable stops that reference the guide rail parallel to edge of your material for fast, accurate and repeatable cuts. The guides can be purchased separately or as a set. The Parallel Guide cuts from 5 1/2" to 25 1/2" while the Parallel Guide Extension cuts from 1/16" to 7 7/8".

201182	parallel guide	\$288.00
201183	parallel guide extension	\$160.00





FESTOOL® HK 55 EQ-FSK420 Circular Saw

The HK 55 EQ Circular saw is the ultimate in efficiency. This saw is not only faster and more accurate than other jobsite saws, the unparalleled level of Festool quality is built in to every aspect of this saw. You can perform practically all jobsite cutting tasks with this one tool. Making exact and repeated cuts quickly and accurately anywhere without taking materials to a miter saw or sacrificing accuracy with a standard circular saw makes this the ultimate solution for all wood processing on the jobsite. Includes: HK 55 EQ Circular Saw, FSK 420 Guide Rail, 18-Tooth Saw Blade, SYS 5 SYSTAINER, Owner's Manual and a Three-Year Warranty.

575085	HK 55 EQ-FSK420 (shown).....	\$560.00
561756	HK 55 EQ (Saw Only)	\$440.00
769941	FSK 250 Guide Rail	\$150.00
769942	FSK 420 Guide Rail	\$175.00
769943	FSK 670 Guide Rail	\$200.00
500463	HK 12-Tooth, Rip Blade.....	\$46.00
500461	HK 18-Tooth Standard Blade ...	\$52.00
500462	HK 32-Tooth Fine Blade	\$62.00



FESTOOL® MFT/3 Multifunction Table

The improved design MFT is taller and is 15% lighter but still provides a strong, sturdy, portable 28 1/4" W x 43 3/8" D x 35 1/2" H, work table that folds to 7 3/32". Max. work thickness: 3 1/16"; max. working width: 27 9/16"; working height: 35 7/16". Includes (2) guide rail supports, angle unit, fence rail, adjustable stop and guide rail FS 1080. Weight: 62 lbs.

495315 \$685.00

Clamping Elements, for clamping on MFT, qty. 2.
488030 (A) above..... \$118.00

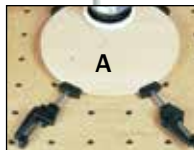

FESTOOL® MFT/3 Kapex Multifunction Table

Designed specifically for use with the Kapex sliding compound miter saw. Table is 22 7/8" W x 34 7/32" D x 31 1/8" high, 42 lbs., and folds to just 8" thick.

495465 \$475.00

Accessories:

Quick Clamp for use with MFT or guide rails.

491594 (not shown)..... \$40.00

Clamping Elements, for clamping on MFT, qty. 2.

488030 (A) above..... \$118.00

201402

FESTOOL® TSC 55 Cordless Track Saw

The TSC 55 Cordless Track Saw delivers the most versatile, precise cutting system available to go wherever the work takes you. Powered by two 18V, 5.2 Ah batteries, the TSC 55 can zip through over 320' (100 meters) of sheet goods on a single charge.

TSC 55 Plus-XL-FS includes: Festool TSC 55 Cordless Track Saw, 2x TLC 3 Chargers, 2x 5.2 Ah Li-Ion Batteries, 55" Guide Rail, 48-Tooth Blade, Chip Collection Bag, Splinter Guard, Limit Stop, and T-LOC Systainer - SYS 5.

TSC 55 Basic includes: Festool TSC 55 Cordless Track Saw, 48-Tooth Blade, Chip Collection Bag, Splinter Guard, and T-LOC Systainer - SYS 5. This model DOES NOT include Batteries (500531), Charger (499412) or Guide Rail (491498).

Specifications:

- Battery Voltage: 18/36V
- Battery Capacity: 5.2 Ah
- Saw Blade Speed: 2,650-3,800 (1 x 18V) / 2,650-5,200 (2 x 18V)
- Saw Blade Diameter: 6 1/4" (160 mm)
Bevel Cuts: -1 to +47°
- Cutting Depth (with Guide Rail): 1 11/16" (50 mm) straight down & 1 7/16" (37 mm) at 45°
- Cutting Depth (without Guide Rail): 2 1/8" (55 mm) straight down & 1 11/16" (43 mm) at 45°
- Arbor Size: .787" (20 mm)
- Weight: One Battery 10.1 lbs. (4.6 kg)
- Weight: Two Batteries 11.7 lbs. (5.3 kg)
- Warranty: Three Years

201402 TSC 55 Plus-XL-FS \$885.00

574685 TSC 55 Basic..... \$465.00

FESTOOL® TXS Compact Drill Set, 10.8V, 2.6 Ah

Festool's TXS Compact Drill Driver will conquer tight spaces, dark spots, and corners are no match for the ultra-compact, engineered for big performance TXS drill/driver. At fewer than 2 lbs., the TXS Cordless Drill packs more features, technology and ingenuity than any other cordless drill and comes equipped with a built-in fuel gauge, LED light, four-bit magnetic storage, removable reversible belt clip, high and low speeds, multiple-position clutch, and is compatible with Festool system accessories and Centrotec drill bits.

Specifications:

- Motor: DC
 - RPM: 0-400 RPM & 0-1,200 RPM
 - Battery: 10.8V, 2.6 Ah
 - Chuck Capacity: 1/32" - 3/8"
 - Charge Time: ~ 30 min. to 100%
 - Weight: 1.98 lbs.,
 - Warranty: Three years
- Includes: TXS Drill Driver, MXC Charger, (2) 10.8V - 2.6 Ah Lithium-Ion Batteries, Centrotec Chuck, Right Angle Chuck, 3/8" Keyless Chuck, BH 60 Centrotec Bit Holder, PH 2 Bit, and T-LOC Systainer SYS 1.

564514 \$390.00

500243 10.8V, 2.6 Ah Li-Ion battery..... \$45.00



FESTOOL® T+3 PLUS Brushless Li-Ion Cordless Drill

The revolutionary EC-TEC brushless motor, combined with all new 5.2 Ah battery packs, delivers ample power to tackle a million screws with minimal wear. Imagine a drill that does the thinking. This drill beeps when the desired torque setting is reached while driving screws. T18+3 Include: Drill, (2) 5.2 Ah Batteries, Charger, Keyless Chuck, Centrotec Chuck, Centrotec Bit Holder, and T-LOC Systainer - SYS 2.

Specifications:

- Motor Type: EC-TEC Brushless
- Battery Voltage: 18V
- Battery Capacity: 5.2 Ah
- Speed Ranges: 0-450 / 0-1,500 RPM
- Chuck Capacity: 1/16" - 1/2"
- Warranty: Three Years

564574 T18+3 PLUS - Brushless Li-Ion
Cordless Drill..... \$495.00



FESTOOL® C PLUS - Brushless Li-Ion Cordless Drill

The revolutionary EC-TEC brushless motor, combined with all new 5.2 Ah battery packs, delivers ample power to tackle a million screws with minimal wear using a compact D-Handle design. The incomparable FastFix system uses a keyless, eccentric, depth-stop, right angle and Centrotec system chucks, (all available separately).

C18 Include: Drill, (2) 5.2 Ah Batteries, Charger, Keyless Chuck, Centrotec Chuck, Centrotec Bit Holder, and T-LOC Systainer - SYS 1.

Specifications:

- Motor Type: EC-TEC Brushless
- Battery Voltage: 18 V
- Battery Capacity: 5.2 Ah
- Speed Ranges: 0-450 / 0-1,500 RPM
- Chuck Capacity: 1/16" - 1/2"
- Warranty: Three Years

564615 C18 PLUS - Brushless Li-Ion.....
Cordless Drill..... \$495.00



FESTOOL® CXS, Li-Ion 10.8V Cordless Drill Driver Set

The popular CXS has been updated with a larger 2.6 Ah capacity battery, and an integrated fuel gauge. The new CXS can utilize existing 1.5 Ah batteries from older CXS drills. CXS is equipped with a larger capacity 3/8" keyless chuck. Set Includes: CXS Drill Driver, Two 10.8V - 2.6 Ah Lithium Ion Batteries, Charger, Centrotec Chuck, Right Angle Chuck, 3/8" Keyless Chuck, and T-LOC Systainer SYS 1.

564535 \$290.00

500243 10.8V, 2.6 Ah Li-Ion battery..... \$45.00



FESTOOL® SysLite Uni Torch

The SysLite Uni Torch features three LED Lamps, pivoting head, high and low settings, and a battery fuel gauge. Use the removable rafter hook for keyhole slot for nail or screw mounting. Compatible with Festool batteries 10.8 - 18.0V Lithium Ion and Nickel-based battery packs. Batteries sold separately.

500639 D/S \$58.00

500530 15V, 5.2Ah Li-Ion battery..... \$55.00

D/S = Item drop ships direct from manufacturer.



Technical Questions?

Call 1-800-535-4486
For FREE help, and advice!



FESTOOL® Kapex VS Sliding Compound Miter Saw

Model KS 120 EB
The KS 120 is the first 10" miter saw with variable speed, matching requirements of the material for perfect cuts, every time.

- 12" Miter saw Cutting capacity
- 91% Dust Collection efficiency
- Dual laser marking system
- Miter Fast angle transfer device

Specifications:
• Power Consumption: 13 Amps
• Speed: 1,400-3,400 RPM
• Cutting depth: 90°/90°- 12" x 3¹⁵/₃₂"
Left/right: 45°/90° - 8¹⁵/₃₂" x 3¹⁵/₃₂"
Left: 45°/ 45° - 8¹⁵/₃₂" x 2¹/₈"
Right: 45°/45° - 8¹⁵/₃₂" x 1³/₈"
Special cutting depth: 4²³/₃₂" x 3/4"
• Crown nested capacity: 6⁵/₈", Max Bevel: 47°/47°
• Miter range: 50°/60°
• Dust port: 27/36 mm
• Dim.: 28" W x 19³/₄" D x 18¹/₂" H
• Weight: 47 lbs.

Includes: angle transfer device, hold-down clamp, wrench and high-quality 60-tooth carbide blade.
561287\$1,475.00

Colliflower Zero Clearance Insert For Kapex Miter Saw

Slip-in/slip-out machined aluminum, insert provides perpetual zero clearance, replaceable 3mm expanded PVC inserts. No saw modification needed.

- 160168\$39.99**
- 160169 Replacement Inserts, 4-Pack\$9.99**



FESTOOL® Carvex 420 EBQ Series Jigsaws

The Carvex Jigsaws fully automatic blade guidance system helps control blade drift aided by a 4-LED, stroboscopic lighting system. Each Model includes: Carvex Jigsaw, SYS-1 T-LOC Systainer and Three-Year Warranty.

Carvex PS 420 EBQ Barrel Grip Jigsaw 561593\$372.00

Carvex PSB 420 EBQ D-Handle Jigsaw 561608\$372.00

FESTOOL 420 EBQ Carvex Jigsaw Accessory Kit, Imperial

The ultimate Accessory Kit includes: Dimpled Base Plate, Hard Fiber Base Plate, Metal Cutting Base Plate, Angle Base, Guide Rail Adaptor Base, Circle Cutter, Five Splinter Guards and Systainer SYS 2 T-LOC.

201186\$213.00

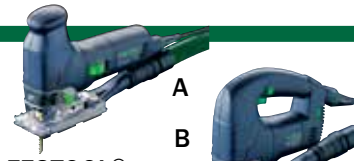

FESTOOL® Pendulum Jigsaws

- Powerful 720 watt Motor
- Dual Port Dust Extraction
- Multi-Material Speed Control
- Triple Blade Guidance System
- Bevels 45° to either side
- Full 1" stroke - 1,000-2,900 SPM
- 4-stage stroke adjustment
- Non-marring sub-base

Includes: Chip guard, Splinterguard and SYS 1 T-LOC Systainer. Available in two handle configurations.
Barrel Grip Jigsaw, model Trion PS 300 EQ. 561443 (A)D/S \$250.00

D-Handle Jigsaw, model Trion PSB 300 EQ. 561455 (B).....\$250.00



BOSCH Barrel Grip Jigsaw, JS470EB

The Bosch JS470EB Jigsaw features a powerful 7.0 Amp, variable-speed motor with Constant Response™ circuitry that maintains desired speed under load. With a tool-less blade-change system. Includes: Barrel Grip Jigsaw, Blade, Anti-Splinter Insert, Plastic Overshoe, Bevel Wrench and Carrying Case.

- Specifications:**
- Motor: 120V, 7.0 Amp
 - Speed Range: 500-3,100 SPM
 - Stroke: 1"
 - Blades: "T-Shank"
 - Bevel Angle Range: ±45°
 - Cutting Capacity Soft Wood: 5⁷/₈"
 - Cutting Capacity Aluminum: 7/8"
 - Cutting Capacity Mild Steel: 3/8"
 - Max. Bevel Cut: 45°

853154\$159.99

BOSCH 12V Max 3/8" Drill Driver Kit, PS31-2A

The Bosch PS31-2A 12V Max System gives you advanced lithium-ion technology by providing up to 5X more charges, 2X longer runtime and 7X more total work than comparable systems on the market. Kit includes: 12V Max Cordless Lithium-Ion 3/8" Drill Driver, (2) 12V Max. Lithium-Ion Batteries, 30-Minute Charger and Carrying Case.

- Specifications:**
- Series: 12V Max
 - Battery Type: 12V Li-Ion
 - RPM: 0 - 350 / 0 - 1,300
 - Torque: 265 in-lbs.
 - Chuck Size: 3/8" Single Sleeve
 - Clutch Settings: 20 + 1
 - Built-In Features: Fuel Gauge & LED Light
 - Length: 7"
 - Weight: 2.14 lbs.

153518\$129.99



BOSCH 2 1/4 HP VS Plunge And Fixed Base Router Kit, 1617EVSPK

Bosch includes a plunge base and fixed base with the powerful 2 1/4 HP motor with soft start and advanced speed-control technology. Kit includes: 2 1/4 HP VS Motor, Fixed Base, Plunge Base, 1/4" and 1/2" Self Release Collets, Shaft and Collet Wrenches, Plunge and Fixed Base Chip Shields, T-Handle Height Adjustment Knob, Hardware for Router Table Applications and rugged Carrying Case.

- Specifications:**
- Motor: 2 1/4 HP, 120V, 12 Amp
 - Speeds: VS 8,000 - 25,000 RPM
 - Speed Control: Dial
 - Base Diameters: 6" Fixed & 6¹¹/₁₆" Plunge
 - Base Openings: 3 3/4" Fixed and Plunge
 - Subbase Openings: 2" Fixed and Plunge
 - Weight: 19.5 lbs.

822704\$219.99



BOSCH 2 1/4 HP VS Fixed Base Router, 1617EVS

Includes: 2 1/4 HP VS Motor, Fixed Base, 1/2" and 1/2" Self Release Collets, Shaft and Collet Wrenches, Chip Shield, T-Handle Height Adjustment Knob and hardware for Router Table Applications.

814269\$169.99

BOSCH 12V Max Impact Driver Kit, PS41-2A

The Bosch PS41-2A 12V Max System gives you advanced lithium-ion technology by providing up to 5X more charges, 2X longer runtime and 7X more total work than comparable systems on the market. Kit Includes: 12V Max Cordless Lithium-Ion Impact Driver, (2) 12V Max Lithium-Ion Batteries, 30-Minute Charger, Carrying Case.

- Specifications:**
- Series: 12 V Max
 - Battery Type: 12V Li-Ion
 - RPM: 0 - 2,600
 - Torque: 930 in-lbs.
 - Chuck Size: 1/4" Hex
 - Built-In Features: Fuel Gauge & LED Light
 - Length: 7"
 - Weight: 2.13 lbs.

153519\$129.99

BOSCH Dual Bevel Glide 10" Miter Saw, CM10GD

Bosch's patented Axial-Glide system replaces the traditional sliding rail system with a hinged or articulating glide arm system, which provides a more compact miter saw that delivers durable precision while remaining true and smooth overtime. Includes: CM10GD Glide Saw, 10" 60T Blade, Material Clamp and Dust Collection Bag.

- Specifications:**
- Motor: 110V, 15 Amp
 - Bevel: Dual
 - Blade Speed: 4,800 RPM
 - Cutting Capacity (0 Miter/0 Bevel): 5 1/2" x 12"
 - Bevel Angle (Left & Right): 47°
 - Miter Angle: 52° Left & 60° Right
 - Positive Miter Detents: 9
 - Weight: 64 lbs.

863656\$599.99

Gravity Rise Miter Saw Stand 841931\$299.99

BOSCH 6" VS Random Orbit Sander With Vibration Control ROS65VC-6

Bosch's ROS65VC-6 boasts the industry's lowest vibration, highest removal rate and efficient onboard dust extraction through the 6" (6-hole) sanding pad. Includes: 6" VS ROS, 6" Soft Backing Pad, Vacuum Hose Adaptor, Pad Wrench, Front Handle and Dust Canister.

- Specifications:**
- Motor: 120V, 3.3 Amp
 - Eccentric Offset: 5/64"
 - Length w/Canister: 16"
 - Length w/o Canister: 10⁵/₆₄"
 - Speed: 5,500-12,000 OPM
 - Orbit Diameter: 5/32"
 - Orbit Radius: 5/64"
 - Vibration Level: <2.5m/sec²

853094\$229.99

BOSCH 5" VS Random Orbit Sander, ROS20VSC

The Bosch ROS20VSC combines pad orbit and rotation to deliver fast removal and an ultra-smooth finish. Includes: 5" VS Sander, Soft Sanding Pad, Dust Canister, Vacuum Hose Adapter, Sanding Disc, Dampening Ring and Storage Bag.

- Specifications:**
- Motor: 120V
 - Eccentric Offset: 3/64"
 - Speed: 7,500-12,000 OPM
 - Orbit Diameter: 3/32"
 - Orbit Radius: 3/64"
 - Weight: 4.4 lbs.

857753\$69.99



POWERMATIC Lathe Model 3520B

- Motor: 2 HP, 1Ph/3Ph, 220V, 6.2A
- Variable speed and digital RPM readout: (high 125-3,200; low 50-1,200)
- Spindle lock and built-in spindle indexing on the headstock
- Distance Between Centers: 34 1/2"
- Swing Over Bed: 20"
- Headstock/Tailstock Taper: MT-2
- Spindle Nose: 1 1/4" x 8TPI
- Ram Travel: 4 1/2"
- Hole Through Spindle: 9/16"
- Overall Dimensions: 75" L x 27" W x 58" H

Includes: Safety shield, 3" face plate, face plate wrench, 14" tool rest, ball-bearing live center, brass tipped knockout rod, and drive center.
*Shipping weight: 682 lbs.

831997D/S \$3,999.99



POWERMATIC 15" Planer with Byrd SHELIX® Helical Cutterhead

- 3 HP TEFC, 1Ph, 230V, 15 Amp motor with magnetic controls
- Byrd helical cutterhead w/inserts
- Closed stand with built-in casters
- Cutterhead Diameter (in): 27/8"
- Cutterhead Speed: 4,500 RPM
- Dust Collection Min. CFM: 800
- Feed Rate (FPM): 16 and 20
- Infeed Roller Diameter: 2.070"
- Maximum Depth of Cut: 1/4"
- Maximum Full Width Depth of Cut: 1/8"
- Maximum Planing Thickness: 6"
- Maximum Planing Width: 14 7/8"
- Minimum Planing Length: 8"
- Number of Knives: 98 four-sided inserts
- Overall Dimensions: 48" W x 28" D x 43 1/2" H
- Table Size: 15" x 48" (w/ extensions)
- 43 1/2" H x 28" W

*Shipping weight: 507 lbs.

835284D/S \$3,059.99

159876 replacement carbide inserts for Byrd Shelix Cutterhead, 10 Pack..... \$39.99

RIKON 1" x 42" Belt x 8" Disc Sander Model 50-144

Rikon benchtop combination sander's powerful 5/8 HP TEFC motor spins the 8" disc at 1,725 RPM and the 1" x 42" belt at 3,000 SFPM. Two large cast-iron tables with miter slots tilt 0-45°. The belt table tilts for chisel sharpening. Removable belt plate for sanding curved material. The solid steel base and cast-iron frame for minimal vibration and maximum rigidity. Includes two 2" dust ports.

863631 \$249.99



JET Lathe Model 1221VS

The JET 1221 Electronic Variable Speed Lathe features an enhanced design, variable-speed, and unrivaled speed control.

- Motor: Powerful 1 HP, 1 Ph, 6 Amp
- Speed Range: 60 to 3,600 RPM
- Swing Capacity: 12 1/2"
- Center-to-Center: 20 1/2" between centers
- Spindle: 1" - 8 TPI
- Headstock & Tailstock: No. 2 Morse tapers
- Tailstock: 2 1/4" quill travel
- Digital RPM readout
- Forward and reverse operation
- Intuitive speed controls
- Patent-pending ratchet-style belt tensioning system
- Spindle designed with industrial-style preloaded bearing
- 24 integrated indexing positions

Shipping weight: 137 lbs.

856325 D/S \$799.99

856505 bed extens. D/S \$198.99

856506 stand D/S \$347.99

856507 stdn. extens. D/S \$106.99



JET Lathe Model 1440VS

The 1440VS is JET's newest addition to its line of outstanding JET Woodworking Lathes! The new JET Lathe has a sliding and pivoting headstock, variable speed controls, and redesigned Tool Rest Clamping. This lathe was built with the woodworker in mind and will be a great addition to any workshop.

- Motor: 1 HP, 1Ph, 11/5.5 Amp, 115/230V, Prewired for 115V
- Variable speed from 400-3,000 RPM
- Spindle Bore: 3/8"
- Spindle Speeds : Variable
- Spindle Thread (In./TPI): 1" x 8 TPI
- Spindle and Tailstock Taper: MT2
- Swing Over Bed: 14 1/2"
- Swing Over Tool Rest Base: 11"
- Distance Between Centers: 40"
- Number of Indexing Positions: 36
- Bed Construction: Cast Iron
- Sliding headstock: Pivots 360° with 7 positive locking positions

*Shipping weight: 413 lbs.

861606D/S \$1,599.99

JET Scroll Saw Model JWSS-22

You'll love the exclusive upper mechanism that clamps and tensions the blade in one step. This saw also offers 22" of throat capacity and an arm that tilts 40° left and 45° right, variable speed range, and top lift-spring loaded arm.

- Clamps and tensions blade in one step
- Removable lower blade holder snaps in place quickly and securely
- Large 12 7/8" x 23" cast iron table

D/S = Item drop ships direct from manufacturer.

BOSCH Colt 1 HP VS Palm Grip Router, PR20EVSK

The PR20EVSK Colt 1HP Variable-speed Palm Grip Router features soft-start that reduces start-up torque, while the Bosch Constant Resistance Circuitry monitors and maintains speed under load for consistent performance and overload protection. Includes: 1 HP VS Motor, Palm Grip Base, Straight Edge Guide, 1/4" Self Releasing Collet, Shaft Wrenches and Carrying Case.

Specifications:

- Motor: 1 HP, 120V, 5.6 Amp
- Spd. Range: 16,000 - 35,000 RPM
- Base Opening: 1 9/16"
- Collet Capacity: 1/4"
- Plunge Depth: 1 3/16"
- Subbase Length: 3 1/2"
- Subbase Width: 3 3/4"

831838 \$119.99

*SHIP. WGT: Items weighing more than 150 lbs., or of an unusual size, must be shipped by common carrier. These are charged based on our actual discounted rates plus a minimal handling fee. If the shipment is to a residence or if lift gate service is required, additional fees may be charged by the freight company.



BOSCH Bench Top Router Table, RA1171

The RA1171 tackles a wide variety of routing applications. The sturdy aluminum fence measures 47 8/8" high by 25 7/8" long with adjustable MDF faceplates. The fence has a max opening of 3 3/16" and a max throat opening of 3 9/8". This unit comes with a rigid aluminum router mounting plate that is predrilled for variety of routers. Includes: Bench Top Router Table, Aluminum Router Mounting Plate, 3X Mounting Plate Rings, Mounting Hardware, 2X Adjustable Featherboards, Adjustable Clear Guard, Starter Pin and Guard, and 2X Outfeed Fence Shims.

834197 \$179.99



JET 16-32 Drum Sander Model JWDS-1632

- 1 1/2 HP Motor, 115V
- V.S. Feed Rate: 0-10' per minute
- Stock Thickness: 3" to 1 3/32"
- Minimum Stock Length: 23 1/2"
- Handles stock up to 32" wide with two passes

• Precise Depth Adjustment Control
• Includes Sander and Stand

*Shipping Weight: 175 lbs.

868060 D/S \$1,299.99

JWDS-1632 Infeed/Outfeed Tables 868061 D/S \$129.99

Abrasive Wraps for the Jet 16-32 Drum Sander. Pre-cut, ready to use packs of four strips.

161637 36 grit \$29.99

161669 60 grit \$29.99

161670 80 grit \$29.99

161671 100 grit \$29.99

161672 120 grit \$29.99

161673 150 grit \$29.99

161674 180 grit \$29.99

161675 220 grit \$29.99

161636 36, (2) 80, 120 grit \$29.99

JET Benchtop Spindle Sander Model 708404

This sander is ideal for sanding contours and those hard to reach spots that other sanders just can't get to. It provides a scratch free finish due to the oscillating action of the spindle. Features include a 1/2 HP motor, a large cast iron table that tilts to handle all bevel sanding projects, and built-in dust collection. Five spindle sizes are included as standard equipment: 2", 1 1/2", 5/8", 1/2", and 1/4" as well as two round and two oblong table inserts. A larger 3" spindle is available as an accessory. Shipping weight: 82 lb.

816763 D/S \$489.99

3" Spindle Assembly. Includes spindle with hardware, 3" rubber sleeve.
817457 D/S \$69.99



JET Drill Press Model JDP-17

The JET model JDP-17 features a powerful 3/4 HP induction motor with 16 speeds that will enable woodworkers to tackle any project that comes along.

- Motor: 3/4 HP, 115V, 1 Ph, 6.8 Amp
- Table Size: 14" L x 19" W
- Table Tilt: 90° Left and Right
- Chuck Size: 5/8"
- Spindle travel: 5"
- Xact-A-Laser system easily identifies the drill center
- Replaceable MDF table insert
- Spindle Speeds: 16 Speeds, 210-3,500 RPM
- Spindle Distance to Table: 30" max.
- Swing: 16 7/8"

*Shipping weight: 187 lbs.

861604 D/S \$739.99



**NOVA
DVR Voyager
18" Drill Press**



Teknatool, maker of the Nova DVR Voyager Drill Press, has produced the world's first smart drill press by combining the best features of classic drill presses with state-of-the-art technology to make your time on the drill press more efficient, fun and safer. This unit combines the proven DVR (Digital Variable Reluctance) technology with some great new features with intelligent ADAPTIVE CONTROL™ software that works for you to produce optimum conditions for your specific projects.

WARRANTY: 2-Year Full Replacement for Motor and Controller and 5-Year Full Replacement for all other parts.

Specifications:

- DVR High Torque Motor: 1¾ HP Direct Drive; 1Ph 110-120V, 15A
- Variable-Speed: 50-5,500 RPM
- Swing: 18"
- Spindle Travel: 6"
- Spindle Taper: MT-2
- Spindle Distance to Table: (Max.) 23½"
- Spindle Distance to Base: 40.94"
- Table Size (L x W): 16½" x 16½"
- Table Tilt (Deg.): -45° to +45°
- Table Rotation (Deg.): 360°
- Chuck Size: 5/8"
- Column Diameter: 3.62"
- Base Size (L x W): 22¼" x 17¼"

*Weight: (Net/Shipping): 269 lbs./306 lbs.

162540\$1,499.00
162541 magn. shop light \$49.99



**NOVA
1624 Type II
Wood Lathe**

Teknatool's newest lathe is packed with features and quality that you'd expect from a much more expensive lathe! Well designed, with high quality components and great capacity, this lathe has the ability to meet the needs of any turner for a lifetime. With 16" of inboard capacity and 29" of outboard capacity (using the Outboard Tool Rest Assembly), coupled with a 1½ HP custom designed motor, large diameter turnings are not a problem. Capacity between centers is 24" and can be extended in 20" increments with additional bed segments. Other features include eight speeds (214 - 3,600 RPM),

forward and reverse motor function, cam operated belt drive, #2 MT headstock and tailstock, 1¼" 8 TPI spindle, 24-position spindle index with spindle lock, true 360° swivel head, and vibration dampening stand with adjustable feet. Includes: NOVA 1624 II Lathe, Stand, Spur Drive Center, Live Center, 3" Faceplate, 12" Tool Rest and Owner's Manual. Warranty: One Year on the Motor and Five Years on the Lathe Parts and Components.

*Shipping weight 260 lbs.

162341reg. \$999.99
.....**SALE: \$849.99**



**SAVE
\$150**



NOVA Galaxi DVR 1644 Lathe

The DVR features a 1¾ HP, 115V motor that is direct drive, using one-piece rotors and no pulleys or belts for extremely smooth turning performance and 100% transfer of power to the spindle, which is actually the rotor assembly of the DVR motor itself.

Specifications:

- Capacity: 16" Swing Over Bed • Between Centers: 44"
- Swivel Headstock: 360° With 7 Locking Positions
- Spindle Thread: 1¼", 8 TPI • Spindle Taper: 2 MT
- Tailstock Quill Travel: 3", Self-Ejecting

Net Weight: 436 lbs.

*Shipping Weight: 526 lbs.

864682\$2,499.99

**RIKON
6" x 48" Belt/
10" Disc Sander
With Stand
Model 50-122**



The Rikon 50-122 provides plenty of power and sanding capacity for any project. The table tilts down to 45° from horizontal. Cast-iron construction makes this sander vibration-free during operation.

Includes: Steel Stand, Miter Gauge, Safety On/Off Switch, Hex Wrenches, Sanding Belt, PSA Sanding Disc, Owner's Manual and 5-Year Warranty.

Specifications:

- Motor: 1 HP, 120V, 60 HZ, 3,450 RPM (no load)
- Belt Speed 1,836 FPM (no load)
- Disc Speed (no load): 2,510 RPM
- Sanding Belt Frame Tilt: 0 - 90°
- Belt Fence Size: 8¾" x 2½"
- Belt Fence Tilt: 90°
- Disc Table Size: 13" x 6¼"
- Disc Table Tilt: 90° - 45° (135°)
- Miter Gauge "T" slot: 5/8" x ¼"
- Dust Port (1): 2" OD, 1¾" ID
- Power Cord: 6'
- Weight: 85 lbs.

861425\$369.99

**RIKON Mortiser
With Dual Axis
Table**

The cast-iron machined steel table moves left, right, forward and back on dovetail ways. It features adjustable chisel depth and mortise lengths stops. Forward control wheels position your work precisely. Includes: Mortiser with Dual Axis Table, ¼", 5/16", 3/8" and ½" Mortise and Chisel Sets, 6" Extension Rods, Tool and Chisel Holder, and User's Manual with Parts Breakdown. 5-Year Warranty.

Specifications:

- Motor: ½ HP, 120V, 60 HZ
- Spindle Speed: 1,700 RPM
- Chuck Capacity: ½" (1.5 - 13mm)
- Chisel Range: ¼" to 5/8"
- Chisel Stroke: 5"
- Maximum Hold Down Width: 37/8"
- Maximum Height Under Chisel: 5"
- Table Movement: Lt. to Rt.: 63/8"
- Table Movement: Back to Front: 4"
- Fence Size: 2" H x 7¼" L
- Base Size: 10¾" W x 12½" D
- Weight: 86 lbs.

861204\$379.99



**RIKON
Midi Lathe
Model 70-220VSR**

Powered by a 1 HP variable-speed motor that offers 12½" swing over the bed. With this power and capacity, this RIKON machine is one of the largest midi lathes available.

Specifications:

- Motor: 1 HP, 1Ph, 120V, 6 Amp, 2900 RPM, TEFC
- Spindle Speed Range: 250 - 3,850 RPMs
- Speed Ranges: 250 - 750; 550 - 1,650; 1,300 - 3,850 RPMs
- Digital RPM Readout w/Control Dial
- Forward/Reverse Control Switch
- On/Off Switch With Removable Child Safety Tab
- Swing Over Bed: 12½"
- Distance Between Centers: 20"
- Spindle Thread: 1" x 8 TPI

Shipping weight: 115 lbs.

861205\$649.99

862698 stand**D/S \$149.99**



**RIKON
Benchtop
13" Planer
w/Helical
Cutterhead
Model 25-130H**



The 13" Benchtop Planer features a six row helical-style cutter head and 26 HSS insert cutters precision sharpened on two edges and easily changed/rotated. Features a threaded 4-post housing for extra head stability, a side handle for quick table height adjustments, repeat cut setting lever, large fold-up extension tables, flat top for stock returning, and side carry handles.

Specifications:

- Motor: 115V 60 Hz, 15 Amp, 2 HP
- Motor Speed: 22,000 RPM (no load)
- Cutterhead: 2" dia., 10,000 RPM
- HSS Inserts: 26, 6 rows

Capacities:

- Max Cut - Depth: 1/8"; Width: 13"
- Max Cutting Depth (Height): 6"
- Min. Length of Stock: 7"
- Min. Width of Stock: 3/4"
- Min. Thickness of Stock: 3/16"
- Feed Speed (Sq.Ft./Min): 26
- Table Size: 9¼" L x 13¼" W
- Ext. Tables (2): 12" L x 14" W
- Dust Port (OD): 4" or 2½" diameter
- Dust Collection min. CFM: 650
- Noise Level: 100 dB
- Unit Height: 17½"; Width: 26¼"
- Unit Depth: 34¼"
- Base Size: 13¼" L x 22" W
- Net Wgt.: 73 lbs., Ship. Wgt.: 77 lbs.
- Warranty: 5-Year

863179\$679.99

160868 repl. cutter set.....\$59.99

**RIKON
1" x 30" Belt/5" Disc Sander
Model 50-151**

This Rikon combination sander's powerful 110V, 1/3 HP motor spins the 5" disc to of 3,450 RPM and the belt to 3,340 sq. ft./min. The belt and disc tables tilt from 0° to 45° and it has two 1½" dust ports for easy dust extraction.



Specifications:

- Motor: 1/3 HP, 110V motor
- 5" disc 3,450 RPM
- 1" x 30" moves at 3,340 sq.ft./min.
- Two 1½" dust ports

861010**D/S \$109.99**

5" Sand Discs - 10-piece, 2 each of: 80, 120, 150, 180, 220 grits.

848546 10-pc., 5" assort. grits\$10.99

D/S = Item drop ships direct from manufacturer.

Power Tools

RIKON Deluxe 14" Bandsaw

Model 10-326

The Rikon 14" Deluxe Bandsaw provides woodworkers with a powerful motor, impressive cutting capacities and patent pending technology. The powerful 1 $\frac{3}{4}$ HP, 115/230 dual volt motor offers two blade speeds and provides ample power for projects from 13 $\frac{5}{8}$ " wide and 13" high.

Innovative Features:

- **Spring-Loaded, Tool-Less Blade Guides** – Fast, Easy Setting Of The Guides Without Wrenches!
- **Quick-Adjust Rip Fence** – Adjusts For Drift With The Simple Turning Of A Few Knobs! No Tools Needed.
- **Quick-Lock Table Trunnion System** – Handy Lever And Gear Unlock And Set Table Angles In Seconds!

*Shipping Weight: 276 lbs.

865261 reg. \$999.99
 **SALE: \$899.99**



RIKON 10" x 18" Pen Lathe

Model 70-105

The 70-105 Pen Lathe was designed specifically at the request of pen turners who need a sturdy, dedicated machine. This unit is constructed of cast iron so vibration is not a factor. Includes: Lathe, Live Center, Tool



RIKON Mini Lathe

Model 70-100

- 1/2 HP, 115V TEFC motor
- Six speed (430: 810; 1,230; 1,810; 2,670; 3,900 RPM)
- 12" swing and 16" between centers
- Ability to add one or more bed extensions
- 12 position indexing head

RIKON 1 HP Dust Collector

With 5-Micron Filter Model 60-100B

- TEFC Motor' Continuous Duty
 - Built-In Casters
 - 1 HP, 110V, 7 Amp
 - 650 CFM
 - Balanced 9" Steel Impeller
 - 5 Micron Top Bag, Reusable 14 $\frac{3}{4}$ " Clear Plastic Lower Bag
 - 4" Inlet
 - Weight: 61 lbs.
- 847117 1 HP.....\$279.99



Rest, Knockout Bar, Wrenches and a Five-Year Warranty.

Specifications:

- Motor: 1/2 HP, 120V, 60 HZ
- Five Speeds: 500, 1,175, 1,850, 2,225, 3,200 RPM
- Spindle Size: 1" x 8 TPI
- Headstock & Tailstock: MT2
- Ram Travel: 1 $\frac{3}{4}$ "
- Swing Over Bed: 10"
- Distance Between Centers: 18"
- Size: 35 $\frac{1}{2}$ " L x 10 $\frac{1}{2}$ " W x 14 $\frac{3}{4}$ " H
- Net Weight: 74 lbs.
- Shipping Weight: 82 lbs.

863667\$299.99



- Self-ejecting tailstock with 2 $\frac{1}{2}$ " ram travel
- Easy access to the top and bottom pulleys for quick speed changes
- #2 MT head stock
- Overall dimensions: 32" L x 10 $\frac{1}{2}$ " W x 19" H

Includes: 8" tool rest, live center 3" face plate, spur center, and tooling knockout. Shipping weight: 89 lbs.

832637\$399.99
 160845 24 $\frac{1}{2}$ " ext. bed...\$129.99
 832639 6" face plate.....\$25.99
 832640 4" tool rest.....\$18.99
 832641 6" tool rest.....\$24.99
 862698 stand.....D/S \$149.99

RIKON Bench Top 10" Bandsaw

Model 10-305

- 1/3 HP, 3.5 Amp motor
- Speed 2,780 ft/min.
- Safety paddle switch
- Cutting capacities: Height – 4 $\frac{5}{8}$ " Width – 9 $\frac{5}{8}$ " Table – 13" x 12"
- Edge-Facing Thrust Bearings
- 70 $\frac{1}{2}$ " blade range from 1/8" to 1/2"
- Shipping weight: 74 lbs.

150503\$279.99
 831665 stand.....\$69.99
 846362 miter gauge.....\$19.99



RIKON 1 HP, 8" Slow Speed Grinder

With a 1 HP motor, you can tackle the tough grinding jobs that are typical in production shops, as well as the precision shaping and sharpening of hand tools. Tool rests on this machine are extra-large and flat and wheel flanges are cast metal. Grinder includes dual dust collection ports on the rear of the wheel guards. This grinder operates at 1,750 RPM, which is ideal for sharpening operations because it reduces heat build-up and minimizes the possibility for "bluing." Equipped with 1" x 8" white aluminum oxide grinding wheels (60- and 120-grit) mounted on a 5/8" arbor. cast-iron base features anti-vibration rubber feet and is equipped with mounting holes for convenient attachment to a workbench or grinder stand. Grinder comes with Work Light, Tool Rests, Eye Shields, Spark Arrestors, 6' Power Cord And Five-Year Warranty.

863666\$219.99



RIKON 6" Buffer Model 81-600

The 3/4 HP Rikon Buffer is perfect for polishing surfaces of woods, metals, plastics, hardware, rocks, jewelry and more! It is excellent for maintaining sharp edges on chisels and blades, putting buffed finishes on woodturnings, or just keeping other shop hand tools and home furnishings in tip-top, rust-free, polished condition.

863668\$99.99



RIKON Slow Speed 8" Grinder

The Rikon model 80-805 Slow Speed Grinder features a smooth starting, powerful 1/2 HP motor. The grinder operates at 1,750 RPM, which is ideal for sharpening operations because it reduces heat build-up and minimizes the possibility for "bluing." This grinder comes equipped with two 1" x 8" white aluminum oxide grinding wheels: one 120-grit wheel and one 60-grit wheel. The cast-iron base features anti-vibration rubber feet and is equipped with mounting holes for convenient attachment to a workbench or grinder stand. Grinder comes with Tool Rests, Eye Shields, Spark Arrestors, 6' Power Cord And Five-Year Warranty.

158512\$139.99



RIKON Oscillating Spindle Sander Model 50-300

Rikon's oscillating spindle sander is perfect for sanding curves, bev-els, and just about any contour you can dream of. Features include a 1/2 HP motor, a large 14 $\frac{3}{4}$ " x 14 $\frac{3}{4}$ " tilting cast-iron table, built-in dust collection and convenient tool holders. Five 4 $\frac{1}{2}$ " spindle sizes are included as standard equipment: 2", 1 $\frac{1}{2}$ ", 1", 3/4" and 1/2", as well as six table inserts.

866005\$399.99

RIKON 17" VS Drill Press Model 30-217

Add some versatility to your tool arsenal with this variable speed 17" drill press from Rikon. It features a powerful 1 1/2 HP motor, clutch depth stop, cast-iron table, and large cast-iron feed handles.

- Motor: 1 1/2 HP, 115/230V
- RPM: 1,720
- Swing: 17"
- Chuck Size: 5/8"
- Drilling Capacity: 1"
- Spindle Travel: 6"
- Head Rotates: 360°
- Speed Range: 200 – 700/600 – 2,200 RPM
- Quill Diameter: 2 $\frac{5}{8}$ "
- Table: 14" x 14"
- Table Tilts: 90°
- Table Rotates: 360°
- 5-Year Warranty

*Shipping weight: 205 lbs.
 865632\$899.99



SAVE \$40

WoodRiver® Spindle Sander

This compact spindle sander easily works any irregular shape. Includes: six (6) each of sanding sleeves and table inserts; five (5) each of rubber sanding drums and drum washers.

- ### Specifications:
- Motor: 3 $\frac{1}{2}$ Amp 120V, 1Ph
 - Oscillations Per Minute: 5/8" stroke with 58 OPM
 - Sanding Height: 3 $\frac{5}{8}$ "
 - Sanding Drum Diameters: 1/2", 3/4", 1", 1 $\frac{1}{2}$ ", 2" and 3"
 - Sanding Drum Length: 4 $\frac{1}{2}$ "
 - Overall Dimensions: 15 $\frac{3}{16}$ " W x 14 $\frac{1}{8}$ " D x 17" H
 - Weight: 34 lbs.

157889reg. \$169.99
 **SALE: \$129.99**



D/S = Item drop ships direct from manufacturer.

*SHIP. WGT: Items weighing more than 150 lbs., or of an unusual size, must be shipped by common carrier. These are charged based on our actual discounted rates plus a minimal handling fee. If the shipment is to a residence or if lift gate service is required, additional fees may be charged by the freight company.

**SAVE 10%
On LAGUNA**

**LAGUNA
REVO 18|36 Lathe**

- World Class Fit & Finish
- Extreme Low-End Torque
- Cast-Iron Headstock
- Polished Steel Bed
- Cone-Shaped Headstock

Specifications:

- 2 HP, 220V Electronic VS w/DRO
- Spring Loaded Spindle Lock
- Max. Outboard Swing: 32"
- Swing: Over Banjo – 13½", Over Bed – 18"
- RPM: High 135 - 3,500; Low 50 - 1,300
- Tailstock: Quill – 4½", Engraved, Self-Ejecting, Through-Bore: ¾"
- Headstock: Travel – Full Length, Through-Bore: ¾"
- Spindle Size: 1¼" x 8TPI RH

*Shipping weight: 480 lbs.
861424 D/S reg. \$2,499.00
..... **SALE: \$2,249.10**



LAGUNA 14|bx Bandsaw 220V 2.5 HP

World class fit, finish, and design with heavy gauge solid steel frame and equipped with an ingenious patent pending disc-brake that shuts off power automatically, the Laguna 14bx is leading the evolution of bandsaws. The 14|bx has been designed to run smoother with almost no detectable vibration. Magnetic on/off switch and dual mounting positions for the optional Pro Light System comes standard. Available in both 110V (864582) and this 220V model.

Specifications:

- Power: 2.5 HP, 9.8 Amp TEFC 220V
- Resaw Capacity: 12"
- Throat: 13⅝"
- Table Size: 21½" x 16"
- Table Height: 38"
- 7 degree left table tilt
- 45 degree right table tilt
- 2 - 4" dust ports
- Blade length: 115"
- Minimum blade width: ⅛"
- Maximum blade width: ¾"
- Cast iron wheels
- Magnetic starter
- Pyramid shaped spine
- Quick release tension
- Magnetic blade guard
- Laguna Ceramic Blade Guides
- Hi/Low Aluminum Fence
- Worm Gear Rack and Pinion
- Cast trunnion (8" x 13")
- 110V outlet for light acc. (light sold separately)
- Footprint: 17½" x 22½"
- Height: 70¼"

*Shipping Wgt.: 330 lbs
864583 D/S reg. \$1,499.00
..... **SALE: \$1,349.10**



Shown with
Optional
Bandsaw Light
and Mobility Kit



**A
LAGUNA 14|12 Bandsaw**

The Laguna Tools 14|12 Bandsaw is engineered to very exacting standards, including a brass-tipped lock handle for the rip fence, Euro-style adjustable hinges, cast-iron wheels, tracking and tension windows, an oversized table and heavy-duty trunion, just to name a few. Laguna Bandsaw Light and Mobility Kit sold separately.

Specifications:

- Motor: 1¾ HP, 14/7 Amp TEFC, 115/230V
- Laguna Ceramic Blade Guides
- Dual Voltage Motor 115/230, Pre-Wired to 115V
- 12" Resaw
- Table Height 38"
- Blade Length: 115" – Sold Separately (854327)
- 45° Table Tilt Right
- 47° Table Tilt Left
- 21½" x 16" Table
- Quick-Release Blade Tension
- Rack & Pinion Upper Blade Guide
- Hi/Low Aluminum Fence 18" x 5½" x 1½"
- Min. Blade Width: ⅛"
- Max. Blade Width: ¾"

*Shipping weight: 312 lbs.
854323 reg. \$1,097.00
..... **SALE: \$987.30**

LAGUNA Bandsaw Accessories:

- 858172** (A) Lag.Bndsw. Lit.e, 110V reg. \$99.00
..... **SALE: \$89.10**
- 854410** (B) Laguna Mobility Kit..... reg. \$149.00
..... **SALE: \$134.10**
- 864584** dual arm Light, 220V..... reg. \$149.00
..... **SALE: \$134.10**

Laguna Resaw King Blade

- 854327** 115" x ¾" x variable TPI .. reg. \$149.99
..... **SALE: \$134.99**

*SHIP. WGT: Items weighing more than 150 lbs., or of an unusual size, must be shipped by common carrier. These are charged based on our actual discounted rates plus a minimal handling fee. If the shipment is to a residence or if lift gate service is required, additional fees may be charged by the freight company.

D/S = Item drop ships direct from manufacturer.

NEW

Laguna C|Flux:2 Cyclone Dust Collector

The C|Flux:2 sets a new standard for cyclones. The horizontal chute is designed to maximize airflow while improving CFM. All shapes and dimensions have been designed to optimize performance. The C|Flux:2 comes standard with a 1-micron canister providing filtration of 99.7% of particles 1 micron or larger and features 109 square feet of polyester spun bond pleated filter to ensure maximum airflow. A 270° manual rotating cleaning bar comes standard. The ingenious lift system quickly moves the drum off the floor and seals against the drum lid, avoiding the need for a flex hose. This design allows for much better portability.

See pages 16-19,
Visit your Woodcraft Store, or
woodcraft.com for Dust Collection
fittings & hose accessories



**SuperMax
19-38 Drum Sander**

Take your sanding to the next level with a SuperMax sander. The 19-38 Drum Sander comes standard on SuperMax's open stand, and the drum is pre-wrapped with 80-grit sandpaper. It features simple one-nut conveyor head alignment.

Specifications:

- Drive Motor (TEFC): 1¾ HP
- 110V 20 Amp
- Conveyor Motor: 43 in./lb. torque, direct drive
- DC motor, infinitely variable 0-10 FPM
- Maximum Width: 38" (two passes)
- Minimum Length: 2¼"
- Maximum Thickness: 4"
- Minimum Thickness: 1/32"
- Dimensions: 42" L x 26" W x 24" H
- Drum: 5" W x 19" L extruded aluminum
- Drum Speed: 1,740 RPM
- Dust Hood: One 4" vacuum port (min. 600 CFM recommended)

- *Shipping Wgt: 286 lbs.
- (3 boxes including stand)
- 857815** **\$1,399.00**

Infeed/Outfeed Tables
for 19-38 sander
857828 **\$109.00**

Swivel and Lock Casters
for 19-38 sander
421632 **D/S \$89.99**



Patented Abrasive
Attachment System



**(A) SuperMax
Pre-Cut
Abrasive Wraps
For 19-38
Sanders**

- Packs of three strips.
- 857817** 36, 80, 120 grit.... **\$29.99**
- 857818** 36 grit..... **\$29.99**
- 857819** 60 grit..... **\$29.99**
- 857820** 80 grit..... **\$29.99**
- 857821** 100 grit..... **\$29.99**
- 857822** 120 grit..... **\$29.99**
- 857823** 150 grit **\$29.99**
- 857824** 180 grit **\$29.99**
- 857825** 220 grit **\$29.99**



DeWALT Two Speed 13" Planer Model DW735X*

Powerful 15 Amp motor drives the cutterhead at 10,000 RPM for cuts, up to 1/8". Three knife cutterhead delivers 30% longer knife life and makes knife changes easier. Two-speed gear box optimizes cuts at 96 or 79 per inch. Automatic carriage lock reduces the movement that causes snipe. Maximum depth of cut 1/8", 6" depth and 13" width capacity. Includes dust hose adapter and ejection chute. Shipping weight: 101 lbs.

845599\$649.99
825518 stand.....\$199.99

DeWalt 1.25 HP Variable Speed Compact Router, Clear Plunge Base with LEDs Model DWP611PK

Specifications:

- Motor: 1.25 HP
- Variable Speed w/Soft-Start: 16,000 - 27,000 RPM
- Collet Diameter: 1/4"
- Plunge Base Stroke: 2"
- Fixed Base Adjustment: 1.5"
- Depth Stop: 5-Position
- Base Dimension: 4" (standard), 4 3/8" x 5 3/4" (plunge)
- Spindle Lock
- Tool Weight: 4.1 lb. (fixed); 6.2 lb. (plunge)
- Shipping Weight: 8 lbs.

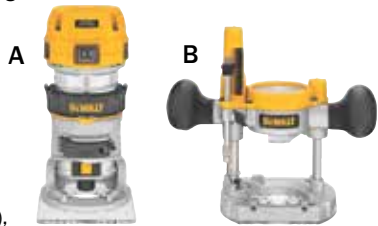

848065 A & BD/S \$209.99
848343 (A) compact router \$149.99
413548 (B) plunge base\$89.99

Portamate PM-P254, 3 1/4 HP, Variable Speed Router Motor
Designed specifically for use with router lifts or CNC machines that specify a 4 1/4" diameter router motor, this heavy-duty industrial-quality, 3 1/4 HP, 15 amp router motor offers a variable-speed control and premium NSK bearings for extended life with minimal bit run out. The adjustable speed control is completely



sealed, and is engineered to maintain constant speed under load. Additional location pins make the router motor compatible with standard 3 1/4 HP router motor bases. Includes: router motor, 1/2" and 1/4" bit auto-release collets, two offset wrenches, and operator's manual. one-year warranty.

Specifications:

- Motor: 3 1/4 HP, 15 Amp, 120V
- Variable Speed Range: 10,000- 22,000 RPM
- Motor Diameter: 4 1/4"
- Weight: 10 lbs. • Warranty: 1 Yr.

158997\$229.99

FEIN MultiMaster With Starlock

FEIN has now made the best even better by incorporating the Starlock mounting system in the FMM Multi-Master 350QSL. The FEIN Starlock mounting system is a pin-less, tool-free quick change system for effortless change of accessories. The accessories simply snap into the tool head for a secure and accurately seated connection.

865784 (A)\$199.00

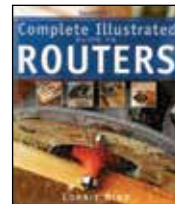

Complete Illustrated Guide To Routers

by Lonnie Byrd. Expand your skills through understanding of the router and how you can you can shape decorative profiles, cut grooves, flush-trim, raise panels, and cut almost any joint with the appropriate bit, and guiding the cut in the proper manner. More than 800 photos and drawings. 240 pages, softcover.

835615\$24.95

FEIN MultiMaster Top with Starlock

Package includes: FMM 350QSL MultiMaster, a Premium Storage Case and an assortment of FEIN accessories for a vast array of applications,



including cutting, sawing, grout and epoxy removal, and sanding from profiles to large surface areas. Made in Germany
865786 (B)\$349.00



CADEX 21 Gauge 2³/₁₆" Combination Pinner/Brad Nailer - With Systerainer Case

The model V2/21.55, 21-gauge 2³/₁₆" Combo Pinner/Brad Nailer gives you the option of using either a non-obtrusive headless pin or the added strength of a headed brad nail. "Sure Grip" comfort coating, anti-dry fire safety mechanism, built-in blow gun, a swivel coupler, belt hook, rear exhaust port, onboard tool storage and a bottle opener! Operates at 70-100 PS, Weight: 2.6 lbs. For a complete selection of 21-gauge fasteners, visit us at woodcraft.com **868188**.....\$299.00

Porter-Cable 3.5 Gallon Portable Air Compressor Model PCFP02003



The Porter-Cable PCFP02003 is a perfect small general purpose shop compressor. This unit features a 3¹/₄ gallon tank with 135 maximum PSI and can supply 2.0 SCFM delivered @ 90 PSI. This compressor has a durable oil-free pump, designed for longer run time and quicker recovery, it will provide long service life with no maintenance.

Specifications:

- Air Delivery @ 40 PSI: 3.0 SCFM
- Air Delivery @ 90 PSI: 2.0 SCFM
- Tank Size: 3¹/₂ gallon
- Running Horsepower: .8 HP
- Power: 120V, 10 Amps
- Cut-Out Max: 135 PSI
- Cut-In Restart: 105 PSI
- Quick-Connect Couplers: 1
- Weight: 26 lbs.

858961\$119.99

ROLAIR AB5 Air Buddy 1/2 HP, 1 Gallon Compressor



The Rolair AB5 Air Buddy, 1/2 HP Compressor may be lightweight and easily portable, but it is also impressively durable and built to last. Pump Description: super quiet Rolair quality, single stage, oilless, one cylinder, ball bearings, cast-aluminum cylinder, stainless-steel reed valve. Motor: 1/2 HP, 4.6 Amp, 3,400 RPM, manual overload protection, 1.15V, 60 Hz, heavy-duty/industrial-grade with ball bearings for greater durability. 68 dBA. Includes: start/stop pressure switch, safety relief valve, intake filter, ball valve drain cock, 1/2 HP, 4.6 Amp motor, pressure-relief valve, airline regulator and pressure gauge, 1/4" universal coupler. Wgt. 25.4 lbs. **160167**\$169.99

GREX Headless Pinners

- Model P635 - 1³/₈"
- Model P645 - 1³/₄"
- Model P650 - 2"
- Model P650XL - 2"

The Grex industrial strength 23 gauge Headless Pinners utilize patented magazines that eliminate the need to adjust for different fastener lengths. The powerful motors will drive fasteners from 3/8" up to 1³/₈" (P635) or 1³/₄" (P645), or 2" (P650 & P650XL) with ease. The compact, lightweight, slim profile is very maneuverable and features a rear exhaust with built-in silencer. Weight: 2.68 lbs. (1.2 kgs.), (3.25 lbs., P650)



operating pressure: 60 - 100 psi, air inlet: 1/4" (6mm) NPT male plug.

- 836278** P635-1³/₈" (shown)\$189.99
- 836086** P645 - 1³/₄"\$249.99
- 838673** P650 - 2"\$269.99
- 863716** P650XL - 2"\$309.00
- 149858** No-Mar tips\$8.99
- 162742** 23ga. edge guide \$24.99

Driver Kit

- 149854** fits P635.....\$34.99
- 149855** fits P645, P650 ...\$48.99

O-Ring Kit

- 149856** fits P635.....\$9.99
- 149857** fits P645, P650 ...\$12.99

GREX Green Buddy 18-Gauge 2" Brad Nailer

Superior internal construction provides smooth and accurate operation. The one-piece precision machined hardened steel driver and anodized internal cylinder and piston valve design delivers robust performance.



Specifications:

- Size: 9¹/₂" L x 2" W x 9¹/₄" H
- Weight: 2.9 lbs.
- Operating Pressure: 70 - 120 PSI
- Fastener Type: 18-Gauge Brad Nails
- Fastener Range: 1/2" - 2"
- Fastener Capacity: 1 Strip (approx. 100 brads)
- Air Inlet: 1/4" NPT Male Plug

- 849249**\$199.99
- 868038** 18ga. edge guide \$24.99

GREX GC1850 Cordless 18-Gauge 2" Brad Nailer

Compact and lightweight cordless finish nailer - with NO compromise on power, the new lightweight and balanced design has the power to sink 2" 18-gauge brad nails into 2"-thick red oak.

Features:

- Operates at high altitudes
- Adjustable power
- Narrow nose and safety design allow driving nails at any angle
- Removable no-mar rubber tip
- Posit-Lock™ Nose Cover dramatically reduces jamming



- Auto trigger lockout prevents empty (dry) firing and alerts user to reload
- Stepped magazine allows tool to access corners

Includes: GC1850 Cordless Brad Nailer, (2) AAA Batteries, Safety Goggles, Adjustment Wrench, Belt Hook, Instruction Manual and Custom Storage Case. Note: Requires Grex Fuel Cell (160982) sold separately. **160981**\$439.99 **868038** 18ga. edge guide \$24.99

GREX Fuel Cells

The Grex GC1850 Brad Nailer fuel cell provides over 1,300 shots per cartridge, they operate at high altitudes and low temperatures. No expiration date.

- 160982** 4-pack\$25.00

Retractable Reel Polyurethane 39' Air Hose

This retractable polyurethane air hose reel eliminates the hassle of dragging air hoses out and then having to recoil them for storage. Mount the hose reel in your shop or garage and you will always have a high quality polyurethane air hose at your finger tips and storing the hose use is a snap. Simply retract the air hose into the reel and it is neatly store, ready and waiting for use. The 1/4" diameter hose retains its flexibility even in the coldest of conditions, is rated at -40°F to +165°F, at a working pressure of 200 PSI. **150316**\$79.99



ROLAIR JC10 1 HP 2 1/2-Gallon Oilless Air Compressor

The super quiet, oilless Rolair JC10 Compressor features a 1HP, single-stage, two-cylinder motor/pump with cast aluminum cylinders and stainless steel reed valve that runs on low RPM for optimum quiet operation. Standard equipment includes: Start/Stop Pressure Switch, Roll-Cage Design to Protect Pump/Motor, Safety Relief Valve, Intake Filter/Silencer, 8-Amp Motor, Pressure Relief Solenoid Valve, Air Line Regulator and Pressure Gauge.

Specifications:

- Motor/Pump: 1 HP, 110V, 8 Amp, 1,725 RPM
- Number of Cylinders: 2
- Overall Dimensions: 17" W x 16" D x 15" H
- Decibel Rating: 60 dBA
- Weight: 39 lbs.

856904\$239.00



The Rolair AB5 Air Buddy, 1/2 HP Compressor may be lightweight and easily portable, but it is also impressively durable and built to last. Pump Description: super quiet Rolair quality, single stage, oilless, one cylinder, ball bearings, cast-aluminum cylinder, stainless-steel reed valve. Motor: 1/2 HP, 4.6 Amp, 3,400 RPM, manual overload protection, 1.15V, 60 Hz, heavy-duty/industrial-grade with ball bearings for greater durability. 68 dBA. Includes: start/stop pressure switch, safety relief valve, intake filter, ball valve drain cock, 1/2 HP, 4.6 Amp motor, pressure-relief valve, airline regulator and pressure gauge, 1/4" universal coupler. Wgt. 25.4 lbs. **160167**\$169.99

GREX

23 Gauge Headless Pins

500 pieces each of 1³/₁₆", 1³/₈", 1¹/₂", 1³/₄" & 2" Pins. For use in Grex Model 650, 23 Gauge, 2,500 Per Box. **151234**\$15.99

23 Gauge Headless Pins

2,500 per Box
151224 3/8"\$6.99
151225 1/2"\$7.99
151226 5/8"\$7.99
151227 3/4"\$8.99
151228 1"\$9.99
151229 1³/₁₆"\$13.99
151230 1³/₈"\$14.99
151231 1¹/₂"\$16.99
151232 1³/₄"\$19.99
151233 2"\$23.99

23 Gauge Headless Pins

3,000 per Box
 Includes 500 pieces each of 3/8", 1/2", 5/8", 3/4", 1", and 1³/₈" length pins.
839804 3,000 pins\$11.99

23 Gauge Headless Pins

10,000 per Box
147855 3/8"\$10.99
836088 1/2"\$11.99
836090 3/4"\$13.99
836092 1"\$15.99
148940 1³/₁₆"\$19.99
836095 1³/₈"\$19.99
836096 1¹/₂"\$27.99
836097 1³/₄"\$30.99
838672 2"\$34.99

21 Gauge Brads & Pins

5,000 per Pack
145771 1/2" pins.....\$7.50
145773 5/8" pins\$7.50
145775 1³/₁₆" pins.....\$10.50
145777 1" pins.....\$10.50
145779 1³/₁₆" pins.....\$11.99
145772 1¹/₂" brads.....\$7.99
145774 5/8" brads.....\$8.50
145776 1³/₁₆" brads\$11.25
145778 1" brads\$13.99
145780 1³/₁₆" brads\$14.99

GREX 18-Gauge

Galvanized Brad Nails

GREX Brad Nails provide the optimal steel tensile strength. 5,000 per box.
160971 multi-pack\$18.99
160972 1/2" long.....\$6.99
160973 5/8" long.....\$6.99
160974 3/4" long.....\$7.99
160975 1" long.....\$9.49
160976 1¹/₄" long\$10.99
160977 1¹/₂" long\$12.99
160978 1³/₄" long\$14.99
160979 2" long.....\$16.99

ARROW T-50 Fine Wire Staples

1,250 per Box
159637 1/4"\$2.99
159638 5/16"\$2.99
159639 3/8"\$3.50
159640 1/2"\$3.50
159641 9/16"\$3.50

FLEXEEL Polyurethane 15' Coil Hose

Compact, lightweight, flexible, for outdoor or indoor use. The 1/4" diameter, rated at -40°F to +165°F with a working pressure of 200 PSI. **149029**\$30.50



Dust Collection

FREEMAN Air Fittings & Accessories

16-piece Set includes one female 1/4" NPT coupler, two male and two female 1/4" NPT plugs, one male and one female 1/4" NPT adaptors, blow gun with accessory tips, single-foot tire inflator, dial tire pressure gauge and 25-foot coil hose.

- 157750 quick-coupler - male threads.....\$3.49
- 157751 quick-coupler - female threads.....\$3.49
- 157752 air plug - male threads.....\$2.49
- 157753 air plug - female threads.....\$2.49
- 157754 swivel air plug - male threads.....\$3.99
- 157755 push-button cplr.-male threads ...\$6.99
- 157756 (B) push-button cplr.-fml. threads \$6.99
- 157757 male barbed coupler.....\$2.49
- 157759 (A) 16-pc. coil hose acc. pack.....\$19.99



2 1/2" Vac & Dust Collection Accessories
Dust collection system for benchtop tools using your shop vac, or use the 4" to 2 1/2" reducer and outfit your 4" system with a 2 1/2" hose and accessories. Union fitting is required to connect hoses together or to other fittings.

- 128680 2 1/2" x 14" floor tool \$11.50
- 128681 2 1/2" x 20" straight wand.....\$12.99
- 128682 2 1/2" x 14" crevice tool..... \$7.99
- 128683 2 1/2" dusting brush\$10.50
- 128685 2 1/2" hose end fitting.....\$5.99
- 144541 2 1/2" hose union fitting.....\$4.79
- 144655 1 1/2" to 2 1/4" adaptor\$5.99
- 150758 2 1/4" union hose fitting.....\$3.19
- 100108 2 1/2" x 10' hose with end fittings \$16.79
- 100109 2 1/2" x 25' shop vac hose\$29.99
- 128747 2 1/2" ABS blast gate..... \$4.79
- 144281 2 1/2" tee fitting..... \$4.79
- 144282 2 1/2" "Y" fitting.....\$4.79
- 144770 2 1/2" hose hangers (5).....\$3.50
- 150757 2 1/2" flanged inlet fitting.....\$3.99
- 158727 2 1/2" 90° elbow..... \$4.99

Shop Vac Hose Kit contains one 10' hose with end fittings, two straight wands, 14" floor tool, dusting brush and crevice tool.

- 128691 (A) **Save!** \$47.99



Rigid Flex Dust Collection Hose

Bend it, turn it, twist or pull it to collect airborne dust at the source. The hose can be compressed to 12" or extended to 36" all the while holding its shape. Come up with creative uses for it in the shop, especially on your bandsaw, scrollsaw, drill press or sander. Made of tough, rigid polypropylene plastic, for everyday shop use.

- 149580 (A) 2 1/2" x 36"..... \$17.50
- 149581 (B) 4" x 36".....\$24.99



Power Tool Vacuum Hose Assembly

Flexible hose assembly offers a simple connection between your shop vacuum and your portable power tools or specialty jigs equipped with 1" OD or 30mm ID dust ports. Lightweight construction allows freedom of movement, yet efficient dust collection during use with sanders, circular saws, routers and plate joiners, ensuring a clean, safe work environment. Soft, flexible fittings at each end of the hose adapt to your dovetail jig, mortise and tenon jig or pocket hole jig to enhance chip collection at the source.

- 152676 10' x 1 1/2" x 1" vacuum hose.....\$22.99
- 144655 (A) 1 1/2" to 2 1/4" adapter.....\$5.99



Rigid Flex Dust Source Sets

Two different nozzles and hose end fittings convert 2 1/2" or 4" Rigid Flex hose to a system for collecting airborne sawdust and small wood chips at the source. Rigid Flex hose holds its shape so you can point the nozzle in line with the cutting tool making it the perfect accessory for your scroll saw, sander, drill press, band saw or router. Choose the 2 1/2" set for your shop vacuum or the 4" size for your portable dust collector.

- 150512 2 1/2" rigid flex set \$21.99
- 152800 4" rigid flex set..... \$33.50



Hi-Tech Duravent Expandable Sta-Flex™ Hose

High quality, American made hose can be used to connect two 2 1/2" ports or used to collect airborne dust at the source. Hose can be bent or flexed all the while holding its shape and position. The 12" hose fully expands to 32". Kit includes hose end swivel fittings, also sold separately.

- 153515 Sta-Flex hose swivel cuff kit.....\$15.79
- 153516 (A) 2 1/2" hose end swivel cuff.....\$6.29



Heavy-Duty Clear Dust Collection Hose

Polyurethane dust collection hose offers the maximum combination of flexibility and abrasion resistance across a temperature range of -65° to 225°F. Reinforced with a spring steel wire helix for excellent compressibility as well as cut, gouge, and chemical resistance. Designed to handle the rigors of a portable dust-collection system as well as permanent installations. 10' lengths.



- 147881 2 1/2" diameter \$34.50
- 147880 4" diameter, clear \$44.99

FLEXAUST®



Flexadux® PV R-4 Stretch Dust Collection Hose

Flexadux Flexadux® PV R-4 Stretch is a medium weight PVC hose reinforced with a spring steel wire helix that expands to provide optimum flexibility and reach while minimizing storage space. Stretch hose is clear with reverse helix, and both hoses have a relaxed length of 2'. The 2 1/2" ID hose expands to 12', while the 4" ID hose expands to 14'.

- 161625 2 1/2" diameter stretch hose..... \$34.99
- 161626 4" diameter stretch hose.....\$49.99



FLEXAUST®

Flexadux Clear PVC Dust Collection Hose

Flexadux PV is a medium-weight, flexible PVC hose with good abrasion resistance that makes it easy to locate blockages, and the flexible construction makes it maneuverable around machinery and workbenches. 2 1/2" ID hose is ideal for connecting to shop vacuums, and 4" ID is for portable dust collectors. 5" ID is a common size in central dust collection systems, and 6" ID is used to connect to collection drums and cyclones. Temperature range between 20°F to 160°F

- 127761 2 1/2" x 10' DC hose \$27.99
- 127760 4" x 10' DC hose.....\$40.99
- 161627 5" x 10' DC hose.....\$44.99
- 161628 6" x 5' DC hose..... \$34.99

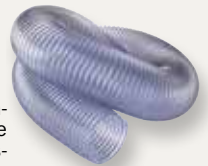

Light-Duty Semi Clear Dust Collection Hose



Light-Duty Semi Clear Dust Collection Hose

Flexadux hose provides an economical solution for central and portable dust-collection systems. Semi-clear material offers a constant view of ship and dust flow, so obstructions are visible. This lightweight, polyurethane hose is reinforced with a polyurethane helix and has smooth interior walls for efficient air flow. 10' lengths.

- 151250 2 1/2" diameter \$17.69
- 151249 4" diameter.....\$24.19



- | | | |
|-----------------------------------|--------|--------|
| Wire Hose Clamps | Each | 10+ |
| 85U66 4" wire clamp (1)..... | \$1.99 | \$1.79 |
| 140606 2 1/2" wire clamp (1)..... | \$2.09 | \$1.88 |

Dust Collection

Our dust collection fittings will help you build a high performance dust extraction system for your shop, designed to stand up against the abrasive nature of saw dust and wood fiber. Because of the danger of static electricity involved with dust collection we highly recommend the book *Dust Control Made simple* be read prior to any installation.

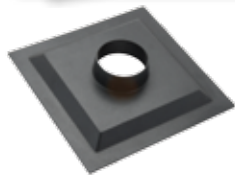
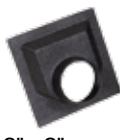

Table Saw Fittings
85009 2 1/2" \$10.50
147758 1 3/2" x 8" \$8.99



8" x 8" Joints Fitting
85014 • \$7.50



4\" Y Fitting
85016 • \$8.99



4\" x 4\" x 2 1/2\" Y Fitting
144930 • \$7.99



Table-Top Dust Collectors
144614 • \$25.19
151293 10\" x 4\" hood \$17.99



4\" T Fitting
85015 • \$9.50



4\" Elbow
85011 • \$8.50



4\" Splice
85012 • \$5.99



4\" Hose To 4\" O.D. Quick-Disconnect
140259 • \$7.99



4\" Aluminum Blast Gate
85007 • \$13.69



Floor Sweep Collector
85010 • \$11.99

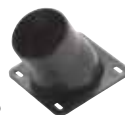

Router Fence Dust Fittings
85013 2 1/2\" \$5.99
147788 Corner mt. \$6.50



6\" To 1\" Universal Adapter 158727 • \$4.99
140791 • \$6.99



4\" To 1\" Multi-Step Reducer
151193 • \$5.99



Universal Tool Adapter
142173 • \$10.99



2 1/2\" Aluminum Blast Gate
149578 • \$11.59



4\" 45\" Elbow
149579 • \$7.99



4\" Swivel Fitting
146489 • \$11.50



ABS Quick-Conn. Thread Gate
149577 • \$10.50



ABS Blast Gate
4\" Hose To 4\" O.D. 142767 • \$7.50



4\" ABS Blast Gate
85006 • \$6.99



Self Clearing 4\" Blast Gate
149576 • \$9.49



2 1/2\" Flex Cuff w/Clamps
153234 • \$8.99



4\" FlexCuff w/Clamps
153235 • \$10.99



4\" Universal Fitting
144654 • \$5.99



1 1/2\" To 2 1/4\" Adapter
144655 • \$5.99



Dust Collection Fitting 4\" 3-Way Junction
153982 • \$16.50

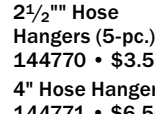

2 1/2\" Hose Hangers (5-pc.)
144770 • \$3.50

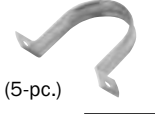

4\" Hose Hangers (5-pc.)
144771 • \$6.50



2 1/2\" Flanged Inlet
150757 • \$3.99

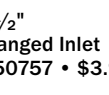

4\" Flanged Hose End
151292 • \$8.99



4\" Flanged Inlet Fitting
152674 • \$5.50



4\" x 2 1/4\" Funnel Reducer
147759 • \$4.99



DWV PVC Pipe Dust Collection System Adapter Fittings
151294 (A) PVC Pipe To DC Fitting Adapter • \$7.99
151295 (B) 4\" Hose To PVC Pipe Adapter • \$7.99
158282 (C) DC Port Cap • \$1.49
Hose and PVC pipe not included



4\" x 2 1/4\" Funnel Reducer
147759 • \$4.99



DWV PVC Pipe Dust Collection System Adapter Fittings
151294 (A) PVC Pipe To DC Fitting Adapter • \$7.99
151295 (B) 4\" Hose To PVC Pipe Adapter • \$7.99
158282 (C) DC Port Cap • \$1.49
Hose and PVC pipe not included



Quick Disconnect Fittings
143660 (A) dbl. Ended. 4\" To 4\" O.D. Fitting\$5.99
154294 2 1/2\" Hose To 4\" O.D. Fitting.....\$6.50
142767 (B) ABS Blast Gate, 4\" Hose To 4\" O.D. \$6.99

Reducer Fittings
144534 4\" To 2 1/4\" (shown)..... \$6.50
85U65 4\" To 2 1/2\"\$6.99
154575 6\" To 4\"\$8.99
154576 5\" To 4\"\$6.99



Dust Control Dual Port Kit Includes:
(1) 4\" Rubber Cuff With Clamps
(1) 4\" x 4\" x 2 1/2\" \"Y\" Fitting
(1) 4\" Wire Hose Clamp
(2) 2 1/2\" Wire Hose Clamps
153547\$17.89

EZ Squeeze Dust Collection Hose Clamps

There is no easier way to connect dust-collection hoses to fittings or machine ports than these EZ Squeeze Hose Clamps. Choose between Single-Loop (SL) and Double-Loop (DL) design in two sizes. The Single-Loop is easier to squeeze for temporary connections while the Double-Loop grips tighter on hose containing an internal wire. Two per pack.

- 149998 SL 2 1/2\" EZ\$5.25\$4.72
- 149999 DL 2 1/2\" EZ\$6.50\$5.85
- 150000 (A) SL 4\" EZ\$6.39\$5.75
- 150001 (B) DL 4\" EZ\$7.50\$6.75

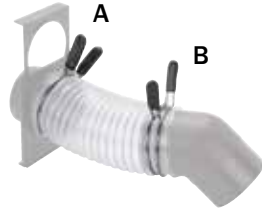

Hose Clamps

Keyed Hose Clamps have a thumb screw that allows you to quickly tighten or loosen them without a screwdriver or wrench.

- Each 10+
141933 (A) 2 1/2\" clamps (2) ... \$4.19\$3.77
- 141934 (A) 4\" clamps (2) \$5.29\$4.76

Standard Hose Clamps

- Each 10+
127762 2 1/2\" clmp (1)\$1.59\$1.43
- 85008 4\" clmp (1)\$1.79\$1.61

Wire Hose Clamps

- Each 10+
140606 2 1/2\" wire clamp (1) ..\$2.09 ...\$1.88
- 85U66 4\" wire clamp (1) \$1.99\$1.79

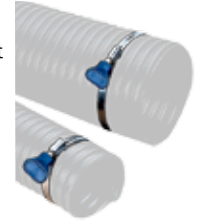

Dust Collection

WoodRiver® Dust Collection System Clean Up Tool Sets

Replace your low capacity portable shop vacuum, and clean up your shop floor, work area and stationary tools with your dust collector and a 4" hose. Unlike ordinary dust collection tools, the generous 6" x 10" opening of the Floor Scoop included in the floor model is fitted with a special glide to protect wood or painted floor surfaces from scratches, and the 36" straight wand can easily be cut to a length that suits your height. The soft touch of the Benchtop Brush Nozzle in the benchtop set protects workbenches and project surfaces from scratches. Both sets feature the Dust Control Handle with an ergonomic grip that is fully adjustable and reverses for operator comfort. Choose left-hand threaded hose end for a convenient shop vacuum style connection or simply slide your 4" hose over the Dust Control Handle, and then anchor with EZ Squeeze Hose Clamp. Both sets include a metal Spring Clip that can be mounted on the wall to stow the assembly out the way when not in use.

- 152842** (A) benchtop DC cleanup set.....**\$37.50**
152843 (B) floor model DC cleanup set..**\$48.50**
152925 4" dust control handle.....**\$16.99**



Trash Can Cyclone Lid

With this lid and a common trash can you collect the larger and heavier shavings and dust before they reach your impeller and dust collection bags. A foam gasket provides a superior seal and an elbow fitting under the inlet side induces a cyclonic air flow. Accepts 4" hose. Fits standard 30-gallon metal trash cans.



- 143290****\$32.99**

Mini Dust Collection Separator. For use with shop vacs. Similar to above, but fits on a 5-gallon bucket. Inlet and outlet accept a 2½" hose. ABS plastic.

- 143868** 5-gallon separator**\$24.19**

Clear Dust Collector Lower Bags

These economical, disposable clear plastic dust collection bags allow you to remove debris directly to a trash can without creating a cloud of dust. The clear plastic lets you instantly see when to change bags so you don't have overflowing dust collectors. Each package contains five 7 mil plastic bags sized to fit most dust collectors. The 500mm bags work with 1½ HP and above models with 20" diameter filters. 370mm works with smaller 14" diameter filters.

- 146068** 500mm, 5-pc.....**\$30.49**
148790 370mm, 5-pc.....**\$19.49**



iVAC Pro Dust Collector Control System

Automate your dust collector with the iVAC PRO Dust Collector Control System! Choose the Remote Control that matches your dust collector's voltage, and enjoy the convenience of a remote control unit to turn on and off your dust controller with the press of a button. This remote control uses a high quality digital wireless system with 40' range. The iVAC PRO switch is built for repeated use with high quality mechanical relay components capable of reliably driving 115V dust collectors up to 1.5HP and 240V dust collectors up to 2HP repeatedly ON/OFF over and again. You can even further automate your dust-collection system with iVAC PRO accessories like the Tool Plus Sensor and Automatic Blast Gates. The Tool Plus Sensor clamps onto the power cord without damaging the wire and automatically detects when your power tool is turned on by sensing the magnetic field around the power cord. When the power tool is turned on, the presence of that field is detected by the sensor and a wireless signal is sent to the iVAC PRO Remote Control to turn on the dust collector. Similarly, when the tool is turned off, the sensor detects the absence of the magnetic field and signals the iVAC PRO Remote

iVAC Automated Vacuum Switch

The Intelligent Vacuum Switch eliminates the distraction of turning on and off a dust collection system while you are operating potentially dangerous power tools. Three modes of operation: Auto - Off - On. Turn-On delay avoids the two power surges occurring at the same time. Turn-Off delay clears work area of remaining debris after tool has stopped. Two input power cords permit operation from two separately protected circuits when the combined load from tool and vacuum exceeds 15 Amps. Both power cords are individually protected with 15 Amp circuit breakers. Rigorously tested for ETL safety approval. Compact, lightweight, wall mount.



FastCap Remote Vacuum Control

Simply attach this remote to the end of your shop vacuum hose using the hook-and-loop strap included in the kit, and you're ready to turn your vacuum on or off with the press of a button. The wireless remote surpasses the convenience of automatic switches by allowing you to locate the vacuum wherever you prefer - even in another room to reduce the noise - and turn it on and off as needed from where you are working. Designed to be used with one shop vacuum at a time. Not rated for continuous operation for long periods of time. Choose from four different channels to support the use of multiple shop vacuums, so a different remote control switches each shop vacuum. Includes 110-volt receiver and wireless remote with hook-and-loop strap with over a 100-foot range. Not to exceed 10-amp load.



- 856230** 0-channel RVC**\$29.99**
856231 1-channel RVC.....**\$29.99**
856232 2-channel RVC.....**\$29.99**
856233 3-channel RVC**\$29.99**



Control to turn off the dust collector. The iVAC PRO Tool Plus Sensor can also send a signal to an iVAC PRO Auto Blast Gate to open or close when the tool powers on. The iVAC PRO 4" Auto Blast Gate lets you automate the connection from your power tool to your dust collector. The unit operates electrically and there are three methods of controlling an iVAC PRO Auto Blast Gate. First, your iVAC PRO Remote Control can be programmed to open and close the blast gate. Second, your iVAC PRO Tool Sensor can be programmed to open the blast gate when the tool is turned on and close when the tool is turned off. Third, a user provided toggle switch can be installed on a wire that will instruct the gate to open or close. 4" molded resin housing construction with self-cleaning motorized metal knife gate powered by included 115V UL/CSA approved AC adaptor. iVAC PRO Remote Control, iVAC PRO Tool Plus Sensor and iVAC PRO Auto Blast Gate are each sold separately.

- 161816** (A) 115-volt Remote Control**\$89.99**
161817 240-volt remote control.....**\$89.99**
162001 (B) Tool Plus Sensor.....**\$59.99**
162002 (C) 4" Auto Blast Gate.....**\$99.99**

Dust Hood With Stand

Capture dust at the source and send it directly into your dust collection system. With an adjustable stand and articulating head, you can easily position this hood at any machine in your shop. Sanding or power carving? Set it up right beside your work area for a dust free environment. The steel pedestal adjusts from 27" to 47" and locks in place. The hood is made of durable plastic with a 15¾" wide and 11¾" high opening and a 4" vacuum hose connection.



- 147113****\$94.99**

i-Socket Vacuum Automator

Have your shop vac start up and shut down automatically every time you turn your sander, router or other handheld power tool on or off. Simply plug your power tool into one socket of the i-Socket Vacuum Automator and your shop vac into the other. Starting the tool will automatically turn on the shop vac, and it will continue to run for approximately seven seconds after you shut the tool off.



- 147369****\$39.99**

HI-TECH DURAVENT ULD Urethane Dust Collection Hose

ULD is a lightweight, ultra-flexible urethane clear hose material that makes it easy to locate blockages. ULD is the perfect choice for handheld use or applications with automated machinery. 10' length with reverse helix. Temperature range between -65°F to 200°F.



- 161495** 2½" x 10'**\$27.99**
161496 4" diameter hose (shown)**\$39.99**

KARCHER WD5/P Tool Activated Shop Vacuum 6.6 Gallon

The WD5/P is a 6.6 gallon vacuum with a powerful 1800-watt, variable-speed motor with onboard power outlet, which is a great option when extracting dust from power tools. When you have your power tool plugged into the vacuum and the tool is turned on, the vacuum will instantly come on. The WD5/P features a filter cleaning tact function that reduces work interruptions and prolongs filter life. Simply depress the tact button, and high-speed air blasts the dust out of the filter, forcing debris back in the container. The WD5/P also features a convenient blower function. Simply remove the hose from the inlet port, plug it into the blower port, and you have a portable blower. Includes: WD5/P, Hose, Hand Grip, Floor Nozzle, Crevice Tool, Wands, Filter Cartridge and Fleece Bag.

- 161498** Karcher WD5/P Shop Vacuum,
6.6 gallon.....**\$199.99**
161499 Karcher Replacement Vac Bags,
4-pack**\$14.99**



Shop-vac Air Cleaner

The unit is 25" long and 13" in diameter and weighs only 15 pounds, so easily fit where dust is being produced. The induction motor quietly moves 235 cfm of air to filter dust as small as 5 microns and will filter 290 square feet every 10 minutes. Remove the end grill for filter maintenance of the included 2-stage filter system. The small size will fit between joists in a basement shop. Includes a 12' cord, and rocker switch. The replacement filter kit includes a foam sleeve secondary filter and cartridge filter.

- 143300****\$134.99**
142211 replacement filter kit**\$25.79**



Small Dust Collection Cyclone System

Reduce the amount of sawdust clogging your shop vacuum's filter with this simple cyclone separator set. This unit connects in-line from your shop vacuum to your woodworking tool to collect dust and chips and reduce the number times you need to empty your shop vacuum. Includes 6-gallon see-through bucket with 12" cyclone separator lid and 90° diverter elbow; two 2 1/2" Rigid Flex hoses expandable from 12" to 36"; four 2 1/4" quick hose connectors; two 2 1/2" wire hose clamps, and one 2 1/4" x 1 1/2" reducer fitting.

- 158525****\$59.99**

*Items that weigh more than 100 lbs. or are an unusual size, may be shipped by common carrier, and will be charged our actual discounted rates plus a minimal handling fee.

RIKON 3 Speed Air Cleaner, 400 CFM

The model 62-400 from Rikon is the perfect air filtration system for a smaller shop or for creating a localized system on a benchtop application. The Rikon 62-400 is specifically designed to filter 98-99% of all particles five microns in size and 85% of particles one micron in size. The outer filter is five micron, and the inner pocket filter is one micron. Model 62-400 offers three speeds: 300, 350 and a maximum of 400 CFM. At high speed, this unit can filter the air in a 20' x 20' x 8' shop seven times an hour. With a programmable timer, you can come into your shop, set the timer for one, two or four hours, and go straight to work without giving it another thought. The system automatically shuts down at the time you've set. These units are designed to be set on a workbench or hung from the ceiling. Air Cleaner comes with: Remote Control, Hooks and Hardware for ceiling mounting, and Owner's Manual.

- Motor: 1/6 HP, 1 Amp, 120V, 60 HZ
- Volume: 20' x 20' x 8' Room = 7 times an hour
- Speeds: 300, 350 and 400 CFM
- Filtration: Outer Filter 5 Micron, Inner Filter 1 Micron
- Sound Level: 50-60 dB
- Built-in Timer: 1-, 2- and 4-hour settings
- Dimensions: 20 1/4" long, 17 1/4" wide and 10 1/4" tall
- Weight: 31 lbs.

- 857601****\$189.99**



RIKON 62-100 3-Speed Air Cleaner With Remote Control

Model 62-100 is 950 CFM and has 3 speeds: 480, 750 and 950 CFM. At high speed, the 62-100 can filter the air in a 20' x 20' x 8' shop 14 times in less than an hour. The outer filter is 5 micron, and the inner pocket filter is 1 micron. The programmable timer can be set for two, four or eight hours. These units are designed to be set on a workbench or hung from the ceiling. Includes: remote control and hardware for ceiling mount applications.

- 152919****\$379.99**
152921 1 micron outer filter.....**\$39.99**

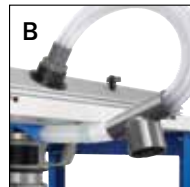
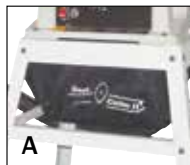

KEEN PRODUCTS For Enhanced Dust Collection

The improved Dust Cutter II is a practical accessory for most contractor style table saws. The Dust Cutter II features three modes of operation including Collector Mode, Funnel Mode and Vacuum Mode. The new Dust Router is the first dust collection accessory that works with router tables of open stand design to protect your router motor from harmful dust that is not collected by the router table fence. Both Keen Products work with most shop vacuums with standard 2 1/4" hose end fittings.

- 151089** (A) Dust Cutter II.....**\$47.50**
151090 (B) Dust Router.....**\$46.99**

JET 1 1/2 HP Dust Collector With Canister Model DC-1100VX-CK*

- Vortex Cone improves chip separation and efficiency
- Motor 115/230V, 1 1/2 HP, 1PH
- 2-Micron Canister
- 1,100 CFM of air flow and 10.5" of static pressure
- Two 4" ports or one 6" port
- Overall dimensions: 37" x 22.5" x 79"

- *Shipping wgt. 172 lbs.
849645 **D/S \$699.99**



JET Air Filtration System Model AFS-1000B

- 3-Stage Filtering - 1 micron
- Remote Control & Timer
- 3 speeds - 550,702 & 1,044 CFM
- Disposable Outer Filter - Washable
- Filters air 12 times an hour for a 20' x 20' x 8' shop

- 815488****\$369.99**
818941 electrostatic filter**\$63.99**



FEIN Turbo II Dust Extractor

Featuring powerful suction and quiet operation, the 8.4-gallon capacity Fein Turbo II Dust Extractor helps you keep your workspace and power tools clear of debris and liquid. An auto-start outlet allows the Turbo II to turn on automatically when used for extracting dust from power tools. When you have your power tool plugged into the vacuum and the tool is turned on, the vacuum will instantly come on. This vacuum also features a protective filter cartridge, so you don't need to change the filter when wet vacuuming, and the vacuum's compact design makes it ideal for maneuvering in tight spaces. Includes: Turbo II Dust Extractor, 1 3/8" Dia. x 13' Hose, Tool Coupling and 8.4 Gal. Filter Bag.

- 861108****\$399.99**



FEIN Turbo Vacuum Replacement Filter Bags
Fleece replacement bags for the Fein Turbo II & Turbo I Models.

- 861118** 5-pack.....**\$41.99**



X-Treme Tape Duct Hose Wrap

Dust-collection systems inherently leak where clamps secure hoses to duct and fittings. X-Treme Tape Duct Hose Wrap seals those joints and repairs punctures in expensive dust-collection hose. It's better than ordinary duct tape because there is no adhesive; it simply sticks to itself, there is no residue after removal and it leaves joints and hoses clean and free of sawdust. 1 1/2" x 25' roll.

- Each 4+
149888**\$25.99**.....**\$23.39**

Safety

ONEIDA® AIR SYSTEMS

Super Dust Deputy™

Turn your inefficient single-stage bag collector into a two-stage cyclone system using your existing blower. Get the available drum kit, or use your own—any size or shape as long as it's airtight. High efficiency cyclone separates 99% of wood waste before it reaches the filter, resulting in virtually no filter clogging or reduction in airflow. Reduced filter maintenance and no dusty bags to empty. Retrofits to 1/2 HP to 3 HP single-stage dust collectors. Cyclone is 23" tall with 5" OD inlet and 6" OD outlet. Optional 17-gallon steel drum kit includes a lid with opening and hole pattern designed to mate with the Super Dust Deputy cyclone. 19"-diameter drum is 15 3/4" tall and includes lever-lock seal ring for airtight operation and easy disposal. Both cyclone and drum feature powder-coated paint finish over welded steel construction, utilizing a compact footprint and simple installation with included assembly gasket and hardware. Made in the U.S.A.

- 154755** (A) Super Dust Deputy Cyclone steel **\$239.99**
154756 (B) 17-gal. steel drum **\$99.99**
154757 6" to 4" reducer fitting **\$8.99**
154756 5" to 4" reducer fitting **\$6.99**

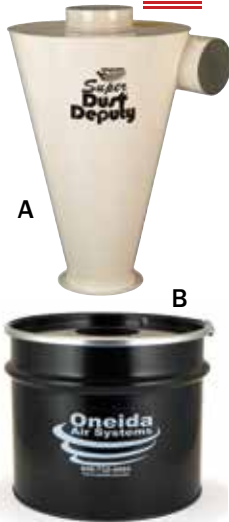

ONEIDA® AIR SYSTEMS

Molded Super Dust Deputy™

Turn your inefficient single-stage bag collector into a two-stage cyclone system using your existing blower. Get the available drum kit, or use your own—any size or shape as long as it's airtight. High efficiency cyclone separates 99% of wood waste before the filter, resulting in virtually no filter clogging or reduction in airflow. Super Dust Deputy retrofits to 1 HP – 3 HP single-stage dust collectors and is 27" tall with 5" OD inlet and 6" OD outlet. XL Super Dust Deputy retrofits to 3 HP – 5 HP single-stage dust collectors and is 38" tall with 6" OD inlet and 6" OD outlet. Lightweight molded resin resists a static charge and has low center of gravity, so there is less danger of tipping on taller collection drums. Optional 17-gal. steel drum kit includes a lid with opening and hole pattern designed to mate with both Super Dust Deputy cyclones. 19" diameter drum is 15 3/4" tall and includes lever-lock seal ring for airtight operation and easy disposal. Drum features powder-coated paint finish and simple installation with included assembly gasket and hardware.

- 158396** (A) Super Dust Deputy **\$169.99**
159878 XL Super Dust Deputy **\$239.99**
154756 (B) 17-gallon drum **\$99.99**
159879 5" to 4" metal reducer **\$13.99**
159880 6" to 4" metal reducer **\$23.50**
159881 6" to 5" metal reducer **\$23.50**



ONEIDA® Air Systems

Dust Deputy

Oneida's Dust Deputy will transform your shop vacuum into an effective dust-collection system. Extremely efficient, cyclonic pre-separator filters 99% of sanding dust with only 1% going into the vacuum; this extends the life of your shop vacuum and filters. 10-gallon steel drum has a molded cyclone with tapered ports to connect a typical shop vacuum to the cyclone outlet. Molded plastic kit includes a molded poly cyclone separator with two 5-gallon plastic buckets, fitted lid and hardware to outfit a portable shop vacuum. Use the molded DIY poly Dust Deputy as a cyclone separator to make your own shop vacuum driven dust-collection system. Note: The Dust Deputy is not for use with highly explosive dust.

- 149951** 5-gal. Dust Deputy kit, shown **\$99.99**
149952 DIY molded cyclone only **\$49.99**
154402 10-gal. Dust Deputy kit **\$174.99**



Bionic Face Shield

Maximize your protection, vision, and comfort. This FaceShield provides extended top-of-head coverage, superior optics and full face visor, comfortable foam back pad, and built-in chin protection. The easy-to-set ratcheting headgear locks into place for a secure fit; headgear adjusts to your choice of 4 visor angles and 2 depth adjustments so it can be adjusted to be comfortably worn with most goggles and respirators. It's lightweight and comfortable for extended wear, and visor replacement is quick and easy. The polycarbonate visor features both anti-scratch and anti-fog coatings. Meets ANSI Z87.1 and CSA Z94.3 standards.

- 147814** **\$56.99**
147815 replacement visor **\$30.75**



TREND® Airshield PRO

Includes FREE Trend Airshield Earmuffs, A \$52 Retail Value!*

Twin filters provides superior protection from nuisance dust. The 8-hour Ni-MH provides up to 7.06 CFM of filtered air flowing across your face and to prevent the visor from fogging. The Airshield PRO comes complete with battery, battery charger, airflow indicator, clear visor overlay, and plastic carry bag. Weighs just 2.21 lbs. Provides eye protection to ANSI Z87.1 and respiratory protection NPF50 to EN 12941 TH2P. PRO clip-on earmuffs for hearing protection rated at NRR 22.

- 152709*** Airshield PRO w/clip-on muffs **\$424.99**
149031 TH2P filters (2) **\$53.99**
149032 visor overlay (10) **\$37.50**
149033 extra 8-hour battery **\$70.50**



Half Mask R95 Disposable Respirator

This disposable respirator from SAS features dual cartridges, twin straps and an exhalation valve. The pre-filters provide short-term protection against airborne oil-based particulates up to eight hours of continuous or intermittent use when spraying solvent-based coatings, and are replaceable.

- 153977** medium **\$20.25**
153976 large **\$21.50**

- Disposable Half Mask Respirator R95 Pre Filter**
153978 5-pair **\$9.99**



Dust Bee Gone™

The Best Nuisance Dust Mask!

Made from woven polyester with heavy 3/4" elastic straps with hook and loop closure on the bottom and plastic quick release buckle on the top, this mask forms to all face shapes and even works with beards. Easy to breathe through and it's hand washable. With proper care the Dust Bee Gone Mask can last for years. Three sizes include Medium (woman/small men, neck size 14-15), Large (most men, neck size 15-18), and XLarge (men's neck size 18.5-26).

- 141104** medium - blue edging **\$39.99**
141152 large - maroon edging **\$39.99**
141153 x-large - green edging **\$39.99**



GVS Elipse P100 Mask



The "P100" in the GVS Elipse P100 Mask name means this mask protects against all particulates, offering a minimum efficiency of 99.97% or higher at 0.3 microns particle size. It is made of hypoallergenic materials and has replaceable filters for dust (included with each mask) and nuisance odor (available as replacement filters). Extremely lightweight, the mask fits perfectly to the face without hindrance to the user or his or her selection of eye and hearing protection and comes in two sizes, S/M and M/L to fit most faces.

- 864939** P100 Mask s/m **\$24.99**
865566 P100 Mask m/l **\$24.99**
865569 repl. standard P100 filter **\$11.99**
864940 repl. nuisance odor filter **\$15.99**



Breathe Healthy Antimicrobial Dust Mask

A Breathable Healthy Mask is light, comfortable and lab tested to filter particulates down to 1 micron, plus it utilizes hydrophobic technology that wicks moisture away from your face, and also features hospital safe AEGIS antimicrobial treatment, which lasts for the life of the mask and offering protection against dust, pollen, dander, mold spores, many bacteria, effluents from coughs and sneezes, and wood dust. Masks may be reused after hand washing with a non-allergenic laundry detergent. Available in one size, which fits most adults.

- 155437** **\$17.99**

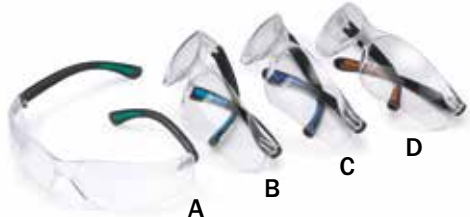

FASTCAP

Magnifying Bifocal Safety Glasses

When 64ths seem to merge together on your rule but your vision is otherwise near normal these bifocal magnifiers provide uncorrected vision in the upper viewing field, correction to focus on nearby objects. Anti-fog coated lenses, and a range of bifocal powers with shatterproof wrap-around lenses with UV protection and reinforced temples. ANSI rated Z87.1

- 147866** (A) +1.5 diopter **\$7.99**
147867 (B) +2.0 diopter **\$7.99**
147868 (C) +2.5 diopter **\$7.99**
147869 (D) +3.0 diopter **\$7.99**

GRR-RIPPER®

MADE IN THE USA

THE SAFEST, MOST PRECISE PUSHBLOCK

Virtually eliminates kickback

Gives you total control of workpiece

Precise 1/4" ripping and work with small stock safely

Beyond pushsticks and featherboards



GRR-RIPPER 3D PUSHBLOCK SYSTEM

Virtually eliminates kickback while controlling pressure in three dimensions – downward, inward and forward. Works with table saws, bandsaws, router tables, jointers and more. See the GRR-RIPPER in action, visit MICROJIG.com today.

146172
GRR-RIPPER Basic
GR-100
\$59.99



820434
GRR-RIPPER Advanced
GR-200
\$79.99



GRR-RIPPER Double Pack Pro

The Double Pack Pro includes two advanced model GR200 GRR-RIPPER® pusher systems and two GRHB-010 Handle Bridge Kits. Each GR200 GRR-RIPPER includes main body, handle, 1/4" side leg, 1/2" side leg, center leg, adjustable spacer, stabilizing accessory plate, balance support and comprehensive user's manual. Made in the USA.

855385 (not shown) **\$179.95**

GRR-RIPPER ACCESSORIES

845406 1/8" Leg..... **\$15.99**
146915 Handle Bridge Kit..... **\$14.99**
150753 Deflector/Connector..... **\$14.99**
861222 Gravity Heel Kit..... **\$15.99**
831910 3-Piece Leg Set..... **\$32.99**

MJ SPLITTER™

Finally, a table saw splitter that is easy to install, easy to use, easy to align and doesn't get in the way. Designed for aftermarket Zero Clearance Throat Plates.



MJ SPLITTER

145612 1/8" Kerf Splitter..... **\$27.50**
146178 Thin Kerf Splitter..... **\$27.50**
845404 1/8" Kerf SteelPro Splitter..... **\$39.99**
845405 Thin Kerf SteelPro Splitter..... **\$39.99**

GRR-RIP BLOCK™

SMART HOOK PUSHBLOCK – THE SMART CHOICE FOR SAFETY. Harness the ultimate gripping power of the only pushblock with smart heel hooks that know where to grab your workpiece.



856321
GRR-RIP BLOCK..... **\$29.99**

ZEROPLAY®

HASSLE-FREE PRECISION MITER BARS

Simple 3-step setup eliminates guesswork and sets your sleds, jigs and fixtures for ultimate precision.



- 1 ONE-TOUCH CALIBRATION®**
Precision fit. No side-to-side play.
- 2 TOP DOWN INSTALLATION**
Square your sled as you tighten.
- 3 BUILD TABLE SAW SLEDS FAST**
Achieve perfectly square cuts.

ZEROPLAY MITER GUIDE BAR SYSTEM

150754 ZEROPLAY Guide Bar System **\$15.99**
845403 ZEROPLAY Guide Bar System
Double Pack **\$34.99**
150755 ZEROPLAY Miter Stop **\$6.99**

MICRODIAL™

THE MOST PRECISE, VERSATILE TAPERING JIG

Cut tapers with surgical precision in 1/8-degree increments up to 10-degrees. Enjoy hassle-free adjustments between repeat cuts with built-in MemoryLock technology. Cut 2-, 4-, 6-, or 8-sided tapered legs with ease and accuracy. Quickstart DVD and project plans included.



MICRODIAL TAPERING JIG

856320 MICRODIAL Tapering Jig..... **\$129.99**



Power Tool Accessories



MAGSWITCH® Workholding System
The **MagJig Universal Base** is the keystone of the system and uses two **MagJigs** (sold separately) to hold the base in place on steel or cast-iron work surfaces. Includes adapters for the use of either 20mm or 30mm **MagJigs**. **MagJig 150** and **MagJig 95** bolt to the **Universal Base** to provide 150-lbs. or 95-lbs. of holding force to any steel or cast iron surface.



The **MagJig Dual Roller Fence** mounts to the **MagJig Universal Base** (sold separately) to create the ultimate "third hand" when you are doing the most difficult and dangerous work. It helps support a tall panel, hold down a long piece of wood or steady your resaw projects. Includes two sets of precision sealed roller bearings for smooth, non-marring flow of material

MagJig Resaw Fence mounts to the **MagJig Universal Base** (sold separately) to form the smoothest resaw guide you will ever use. Angled faces allow for blade drift and make a perfect infeed or outfeed work support.



Pro Model Vertical Attachment is really three tools in one! It can be installed on the **MagJig Universal Base** and used as a vertical hold-down, installed on



MAGSWITCH® MagJigs

MagSquare **MagJig** gives you flexibility to mount anywhere on a steel surface, such as your table saw, jointer, shaper, bandsaw, drill press, or stationary sander. **MagJig** models express breakaway force per unit: 60-, 95-, 150- or an amazing a 235-lb. force.



The **Reversible Featherboard** (152626) connects to the **Universal Mounting Base** and can be flipped for left-hand or right-hand feeds and accommodates the **Vertical Featherboard** for an added dimension of safety.



Magswitch technology is revolutionizing woodworking, giving you unmatched ability to hold your work on any steel or cast-iron table. The innovative **MagJig Universal Base System** is a modular design that combines new and existing components to create unique jigs for holding workpieces for safer, more precise operations. Future **Magswitch** products will be designed around this versatile platform.

the **Pro Model Featherboard** as a vertical hold-down or stacked for tandem use. Includes two sets of risers, 90° arms and hardware.

Vertical Attachment Risers include two sets of risers and necessary hardware for stacking featherboards.



Starter Kit (A) includes: **Reversible Featherboard**, **Universal Mounting Base** and two **MagJig 150s**. **All components of the MagSwitch Workholding System are sold separately.**

- 152625 (A) workholding starter kit.....\$76.99
- 147833 (B) **MagJig 150** (listed at right).. \$36.99
- 147832 (B) **MagJig 95** (listed at right).....\$26.99
- 149496 (C) univ. mounting base.....\$19.99
- 152626 reversible featherboard.....\$17.99
- 149494 (D) dual roller fence.....\$29.50
- 149495 (E) resaw fence.....\$25.99
- 149497 (F) vertical attachment.....\$19.99



Two or more **MagJigs** per fixture are recommended to prevent pivoting. Make your own custom jigs and fixtures using **MagJig** by drilling standard 3/4" stock.

25mm hole for **MagJig 60**, 30mm hole for **MagJig 90**, 40mm hole for **MagJig 150**, and 2 1/4" hole for **MagJig 235**. **MagSquare 165** places a machined 90° fixture mount with a 150-lb. breakaway force anywhere there is a steel surface.

MAGSWITCH® Magnetic Featherboards

Unlike conventional featherboards, which are tied into the miter slot, **MagSwitch** featherboards can be placed anywhere on a steel table or fence surface.



The easy on/off knob makes them convenient to use. **Pro** models have the stronger hold with two 30mm rare-earth magnets. The **Pro Table Magnetic Featherboard** stays in position while the fingers press firmly against the material. The **Pro Table** model can be fit with the optional vertical attachment (sold separately) which accommodates stock up to 2 1/2" thick. **Pro Fence Magnetic Featherboard** provides downward pressure on your jointer table as well as steel fences used on router tables, shaper tables and table saws. **Universal Magnetic Featherboard** with two 20mm rare-earth magnets is perfect for infeed/outfeed applications. The **Universal** model is suitable for use on table saws, jointers, shapers and bandsaws. **Pro Model Vertical Attachment** can be installed on the **Pro Table** model as a vertical hold-down or stacked for tandem use. Adjusts vertically and horizontally and includes one set of risers, 90° arms and hardware. **Vertical Attachment Risers** include two sets of risers and necessary hardware for stacking featherboards.

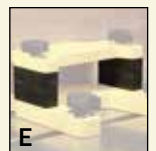
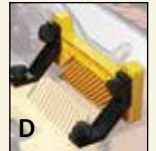

147527 (A) **Pro Table Mag. featherboard** \$66.99
147979 (B) **Pro Fence Mag. featherboard** \$69.99
148442 (C) **Universal Mag. featherboard** \$48.99
149497 (D) **Pro Model vertical attach**.....\$19.99
149498 (E) **vertical attachment risers**.....\$10.25

- 161961 **MagJig 60**..... **NEW!** \$19.99
- 147832 **MagJig 95**.....\$26.99
- 147833 **MagJig 150**.....\$36.99
- 161962 **MagJig 235**..... **NEW!** \$99.99
- 151282 25mm forstner bit.....\$7.99
- 147997 30mm forstner bit.....\$9.99
- 147998 40mm forstner bit.....\$12.50
- 125945 2 1/4" forstner bit.....\$18.99
- 161963 **MagSquare 165**..... **NEW!** \$47.99

Milescraft Featherboards

Milescraft Featherboards feature a dual slide motion design for quick and easy setup as well as a unique pre-load design that allows the appropriate amount of tension to be set consistently. The **Single Featherboard** includes 3/4" and 5/8" miter bars as well as two T-Slot bolts allowing it to be used in nearly any application on router tables and table saws. **D/T Featherboard** includes two molded featherboards and twice the hardware allowing it to be used as either **Dual** or **Tandem** featherboards.

- 148420 single featherboard.....\$15.99
- 148421 D/T featherboard (shown).....\$29.99
- 161960 #3404 PushStick..... **NEW!** \$9.99



Miter Slot Featherboard

Two locking screws, not just one, hold this quick positioning featherboard securely in a standard 3/8" x 3/4" miter slot. The featherboard keeps stock tight against the fence with flexible "feathers", helps prevent chatter while cutting and greatly reduces dangerous kickback. This unit is made of sturdy plastic, is 3/4" T x 4 3/4" W x 6 1/4" L and has 4 1/2" of travel.

- 144518.....\$12.99

KREG® True-FLEX™ Featherboard

The **True-FLEX™ Featherboard** gets its name from the careful engineering that went into its design. Many featherboards apply too much pressure or not enough pressure to the workpiece, resulting in imperfect



cuts and less than safe operation. The featherboard is designed to provide a consistent and optimum pressure and includes an exclusive wedge-lock system, perfect for a miter or T-slot slot on a table saw or a router table. Available as a single featherboard or a special value twin-pack.

- 148436 single featherboard.....\$19.99
- 839194 twin-pack featherboards.....\$36.99

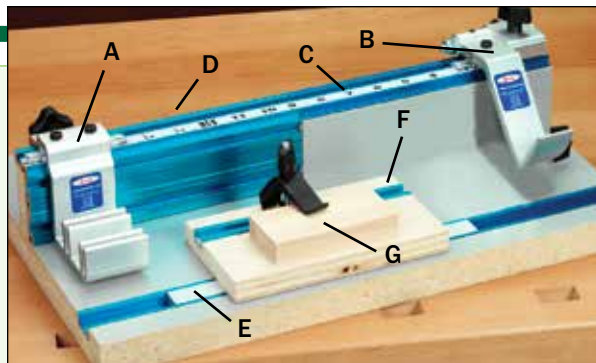

KREG® Precision Measuring System

(A) Solid Production Stop with dual cursors for reading from either side of the blade. It drops onto the top of the fence for easy removal, making this perfect for repetitive, high-production tasks.

(B) Flip Stop has a curved front design that lifts out of the way to bypass the stop for squaring an end or cutting to length without moving the stop.

(C, D) Top and Heavy-Duty Traks. The Top Trak (C) is a rugged anodized aluminum extrusion that can be used to create a precision measuring system for your miter saw, drill press, table saw and more. It features a self-aligning L-shaped mounting foot for easy attachment to a shop-made 3/4" thick fence. The Heavy-Duty Trak (D) is an L-shaped, anodized aluminum extrusion that is extremely straight and perfect for heavy-use applications. It has four T-slots which accept 1/4" hex bolts.

(E) Jig and Fixture Bar is 30" long and has six plugs that adjust to take up any play in your miter gauge slot. Mounting holes every 4".

Miter Combo Track

(not shown) **Combination** 3/4" x 3/8" miter track and 1/4" T-track work with your miter gauge, featherboards, and other accessories to help add tremendous flexibility to your custom jig or fixture.

Precision Micro Adjuster

(not shown) Adds fine-tuning to your swing stop when used with Top Trak or HD Trak.

146053	\$15.99
145823	(A) production stop	\$22.99
145822	(B) swing stop	\$29.99
145826	(C) top trak, 2'	\$21.99
145827	(C) top trak, 4'	\$34.99
145829	(D) heavy duty trak, 4'	\$59.99
145830	(E) jig and fixture bar	\$23.99
149083	(F) t-trak, 48"	\$18.99
145831	(G) trak clamp	\$5.99
145832	R-L self-adhesive tape, 12'	\$9.50
145833	L-R self-adhesive tape, 12'	\$9.50
147943	L-R self-adhesive tape, 3.5 meter	\$9.50
149096	miter combo trak, 48"	\$39.99

Kreg Precision Measuring Systems Kit contains four 2' pieces of Top Trak, two 12' self adhesive tapes (L-R and R-L), one Flipstop and one Production Stop. **146487** **Save! \$144.99**



WIXEY™ Digital Height Gauge With Fractions

A 1 1/2" x 4" base with magnetic strip holds the gauge in place and a large digital readout displays cutter height for exact depth settings or placement of a router fence to 4 1/2" from the miter slot. Gauge displays fractions and decimal equivalents simultaneously so you see the exact fraction, not a rounded approximation. +/- .001", 1/500", or .025mm.

148380 **\$59.99**

WIXEY™ Mini Digital Height Gauge

Wixey digital readout products, noted for superb quality and ease of use, now include a Mini Digital Height Gauge. Accurately adjust the height of a router bit, or saw blade, in seconds with this large easy-to-read digital gauge. The display, which can be adjusted for fractions or millimeters, lies flat to fence, blade or bit for quick positioning, has a locking rule for repeat settings and includes a depth measuring attachment. Measures heights up to 3" and depths to 2", with 1/32" resolution and an accuracy of +/- .004". Includes battery and instructions.

153811 **\$24.99**

WIXEY™ Digital Angle Gauge w/Level

Now it's easy to set perfect preset stops or adjust your saw for any angle. Set the Wixey Digital Angle Gauge on your table saw top, near the blade, and push the zero button. Attach the Angle Gauge to your blade with the built-in magnets and adjust until the desired angle appears on the easy-to-read digital display. Display is in 0.1° increments. This new model has a flip up display for easy reading in any light, built-in level that uses patent pending Dead Level technology, standard AAA batteries and a convenient "hold" feature.

154507 **\$39.99**

BORA Quick Release Large Vise

The BORA 4" Drill Press Vise is a "quick action vise" designed for use with all drill presses. The bottom is slotted, for bolting to a drill table. The vise features steel jaws with V-grooves for securely clamping round material. The quick-release action allows for fast and easy setup, adjustments, and instant release of your work piece. The handle locks 90° to the screw for increased torque. Overall dimensions: 6" x 13" x 2 1/2".

154713 **\$29.99**

WIXEY™ Planer Digital Height Gauge

Now you can stop constantly using calipers to check stock thickness! This unique gauge reads out both decimal and fractional measurements. Mount the Digital Planer Height Gauge and simply lower your planer until the gauge reads .562" - 9/16". It can't get any easier! Fits most portable "lunch box" style planers with easy to follow installation instructions.

146096 **\$64.99**



ONEWAY Multi Gauge

The solid 1 1/4" thick cast iron frame is precision machined at 90° on three sides so you can check squareness of, or accurately position, joiner fences, saw blades or tilting tables of scrollsaws and drill presses. The dial indicator has 1 1/32" of travel for a full 1" measurement in .001" increments. Dial indicator includes a round tip for checking runout and flat tip for saw blade, dado head, or router bit height adjustments. Additional applications include depth of cut measurements, planer/drum sander feed roller checks, and drill bit diameter measurements. This multipurpose tool revolutionizes dial indicator usage in the workshop.

126979 **\$97.50**



WIXEY™ WR300 Type 2 Digital Angle Gauge

The Wixey WR300 Type 2 Digital Angle Gauge is easy to use. Simply "zero" the device on your machine table surface, and then attach it to your table saw blade using its powerful magnets in order to display the bevel angle accurately and precisely. Large fixed display shows angles in 0.1-degree increments. Magnets in bottom surface adhere to cast-iron tables and steel blades. New Type 2 design uses common AAA batteries. Great for setting tilt angle on drill press or sander.

159488 **\$29.99**



WIXEY™ WR550 Remote Planer Readout

Replace the inaccurate stock height gauge on your stationary planer or thickness sander and stop constantly using calipers to check stock thickness! With the Wixey WR550 Remote Planer Digital Readout simply lower your planer cutter head until the display reads the desired thickness. Unique gauge reads out either decimal and fractional inch measurements or millimeters up to 12" thickness. Ideal for large stationary planers and sanders, this model is so flexible and versatile that with a little creativity it can be adapted to almost any machine. The kit includes all mounting hardware, drill bits, thread forming screws and easy-to-follow instructions for installation and calibration. Uses common AAA batteries.

159489 **\$80.50**

Power Tool Accessories



INCRA® MITER 1000HD™ Miter Gauge

The HD stands for High Definition, because the protractor plate's exclusive AngleLOCK Indexing System has 180 angle stops in 1° increments with special stops located at 22½°, telescoping IncraLOCK cut-off fence and Flip Shop Stop, and steel vernier scale that reads to 1/10°, to improve the quality of any project. The Miter 1000HD will allow you to precisely set and quickly duplicate any segmented turning angle you might need to cut, whether it's 18° for 10 sides, 25.7° for 7 sides, or anything else imaginable.

149714 \$199.99



INCRA® I-Box Jig For Box Joints

Use the INCRA I-Box on your table saw or router table to cut great looking box joints with a stack dado blade, box joint blade set, or straight router bits. Faster setup and improved user safety compared to traditional jigs make this tool to use for superior decorative joinery. Add a "wow factor" to your projects with I-Box exclusive joints like the Center Keyed and Splined Box Joint. I-Box can even be used to produce an unlimited variety of classic dentil moldings. Wide fence allows clamping lumber securely into position. Reversible design works on either side of the cutter. 1/8"-3/4" pin widths range with dual-pitch lead screw mechanism for fast micro-adjustment. GlideLOCK adjustable miter bar fits standard 3/4" x 3/8" miter slots. Includes instructional DVD covering basic setups through advanced decorative joinery

854034 \$159.99



KREG® Miter Gauge System

Factory calibrated accuracy starts with a gauge head that is machined on a computerized milling machine for absolute precision. An easy-to-read Vernier scale enables precise angle adjustments up to 1/10 of a degree. Five patented bar adjusters take up the play in the miter slot for a perfect fit. Lastly your workpiece is supported by a heavy duty 24" aluminum fence with an adjustable Flip Stop. Includes a self-adhesive measuring tape.

145765 \$139.99

145822 extra swing stop.....\$29.99

146053 precision micro adjuster\$15.99



INCRA® Miter Gauge 1000SE

Special Edition adds a stainless steel Vernier cursor for an incredible 1/10° resolution between fixed steps. The Special Edition also includes a miter fence that telescopes from 18" to a full 30" in length with the new INCRA Flip Shop Stop™ for patented Automatic Positioning Control™. The saw tooth rack system instantly controls the length of your cut with INCRA's legendary machine shop accuracy as the dual "Flip" arms provide flexibility. The Flip Shop Stop™ is equipped with three sliding stop rods that operate independently or in tandem for one, two, or three simultaneous stop positioner setups.

143842 \$169.99



SAVE!

SPECIAL INCRA® COMBO PACKAGE

Buy an Incra Miter Gauge 1000SE and Incra Miter Express and Save!

147374 Best Value Save!..... \$319.99



INCRA® Miter V120™ Miter Gauge

The Miter V120 is equally at home on the table saw, bandsaw, router table, even the disc or belt sander. Constructed of machined and laser-cut steel components the miter gauge features 120 AngleLOCK™ indexing stops including 1° stop spacing with special stops at ±22½°.

149499 \$89.99

WoodRiver® Aluminum Track For Jigs And Fixtures

- Durable Extruded Aluminum Construction
- Nominal 1/2" Profile Height Fits Dadoes Or Laminated Fixtures



WoodRiver® Standard 1/4" T-Track

- Allows The Use Of 1/4"-20 Nuts And Bolts
 - Predrilled For Using Included Screw Hardware
- 159894 (A) 24" \$10.99
- 159895 36" \$13.99
- 159896 48" \$17.99

WoodRiver® Back-to-Back 1/4" T-Track

- Use 1/4"-20 Nuts And Bolts On Both Sides
 - Shallow Recess On Each Side To Attach 1/2" Measuring Tape
- 159897 (B) 24" \$12.99
- 159898 36" \$15.99
- 159899 48" \$20.99

WoodRiver® Standard 3/4" Miter Track

- 3/4" x 3/8" Miter Track Has A Bottom T-Profile
 - Predrilled For Using Included Screw Hardware
- 159900 (C) 32" \$15.99
- 159901 48" \$20.99

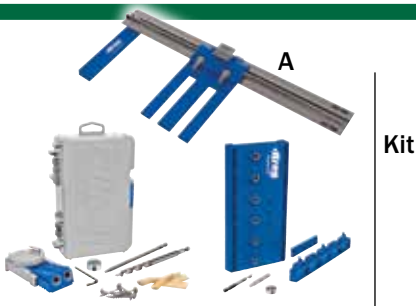

KREG® DIY Project Kit

The DIY Project Kit from Kreg Tool combines three tools for creating custom home projects that will help keep your home organized. Using the included Kreg Rip-Cut™, Kreg Jig® R3, and Kreg Shelf Pin Jig with your drill and circular saw you can build high-quality projects for your home easily and economically. The Kreg Rip-Cut circular saw guide attaches to almost any circular saw so you can cut large sheet goods with precision and with more confidence than ever before. The Kreg Jig R3 makes project assembly straightforward, using just a drill and strong yet simple pocket-hole joinery. Finally the Kreg Shelf Pin Jig will help you drill evenly-spaced, consistent holes for pins that hold adjustable shelves. The DIY Project Kit also comes with 10 FREE, downloadable, step-by-step project plans to learn how you can easily build custom organizers for every room in your home – the garage, closets, basements, bedrooms, kitchen, and beyond.

159560\$99.99

KREG® Rip-Cut™ Circular Saw Guide

The all new Kreg Rip-Cut™ provides a safe and reliable method to cut material from 1/8" to 24" wide with just a simple circular saw. Rip full 4x8 plywood panels down to size quickly and easily. Connects to most left- and right-hand circular saws with a reversible guide arm that provides full support through entire cut. Includes an easy-to-read adjustable scale and detailed instructions.

153926 (A)\$34.99



Portamate® Heavy-Duty And Super-Duty Universal Mobile Bases



The heavy-duty universal mobile base Portamate PM-2500 is a tough, adjustable mobile base for moving large power tools or other heavy objects. Its 650-lb. capacity using formed steel rails is perfect for heavy machines and tools like table saws, bandsaws, planers, jointers, shapers, and sanding machines. It also works well to move large cabinets and toolboxes. PM-2500 adjusts in 1" increments from 12" x 12" to 36" x 36" square or up to a 20" x 52" rectangle. The PM-2500 adds mobility to most difficult to move objects in the workshop, gliding effortlessly to its destination and then setting on the ground with a quick flip of the steel levers with your feet. The mobile base is very low profile, only increasing machine height one inch at rest. Super-duty universal mobile base Portamate PM-3500 uses tubular steel construction to increase capacity to a whopping 1,500 lbs. PM-3500 is perfect for industrial machines like large table saws, metalworking bandsaws, wide capacity planers, jointers, and CNCs. It also works well to move very heavy cabinets and toolboxes – even safes! PM-3500 adjusts from 18 1/4" x 23 1/2" to 28" x 33 1/2" to fit most woodworking machinery.

162003 HD PM-2500 mobile base\$89.99

865291 SD PM-3500 mobile base\$149.99



WoodRiver® Tenoning Jig

Cut perfect straight, angled, or mitered tenons on your table saw safely and easily! Oversized feed handles provide positive, safe operating control while the large crank style handle quickly secures stock up to 3 1/4". A 0° to 45° adjustable backstop supports stock for angular cuts. Its fine adjustment feature guarantees accurate, repeatable cuts. Features built-in provisions for adjustment and alignment to maintain cutting accuracy. Machined cast-iron body parts. Fits any table saw with a 3/4" x 3/8" miter groove.

152712\$99.99



Taper Jig

Accurately cuts tapers up to 3" per foot or 15°. Includes a graduated scale measuring degrees and inches per foot of taper. Aluminum guide bars with 2 5/8" push handle.

03R22\$24.99

COLLIFLOWER Zero-Clearance Insert For Kapex Miter Saw

Chip-out is a thing of the past with this beautifully designed Zero-Clearance Insert for the Festool Kapex Sliding Compound Miter Saw. Constructed of machined aluminum, this insert provides perpetual zero clearance with a slip-in/slip-out, replaceable 3mm expanded PVC insert. No saw modification needed. Includes one replaceable insert.

160168 Zero-Clearance Insert\$39.99

160169 (A) Replacement Inserts, 4-pack...\$99.99

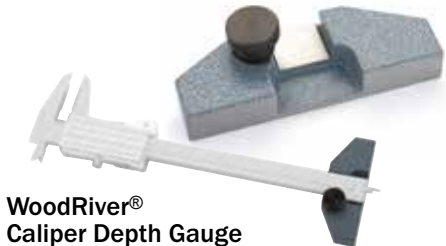

WoodRiver® Caliper Depth Gauge Attachment

Our WoodRiver® Caliper Depth Gauge Attachment works with most 4", 6", 8" and 12" Vernier and dial calipers that have a depth measuring bar. It provides a broad support for measuring holes using a caliper, especially deep holes. The gauge attachment has a polished base for accurate measurement, an easy-to-lock knurled locking clamp, and measures 3" wide.

160116\$19.99



LEECCRAFT Table Saw Throat Inserts

Use With Dadoes Too!

Simply raise your saw blade through the insert to create a "kerf" which precisely matches the blade on your saw. These 1/2" thick inserts are precision machined from a nearly frictionless melamine faced, high density phenolic laminate and offer durability and flatness not found in cheaper plastic inserts. Features like top mounted set screws for precise leveling, front/side adjustment screws for perfect side to side and front to rear fit, and a rear safety pin that keeps the rear of the insert in place, make this the best insert we have ever seen! Craftsman insert measures 14" x 3 3/4" and fits most new, 10" belt drive models. (Check the opening of your Sears saw before ordering). The Powermatic 2000 Blade Insert has a slot for the riving knife. Complete with instructions. Insert surface colors may vary.

	Each	2+ Each
153768 Bosch 4100 blade	\$28.99	\$26.09
153769 Bosch 4100 dado	\$28.99	\$26.09
142759 Delta left & right tilt	\$27.99	\$25.19
152582 Unisaw dado	\$44.99	\$40.49
152649 Unisaw blade	\$39.99	\$35.99
142760 Jet right tilt	\$27.99	\$25.19
142271 Jet left tilt	\$28.99	\$26.09
142021 Powermatic 66	\$28.99	\$26.09
142022 DeWalt DW744 & 746	\$27.99	\$25.19
124214 Craftsman	\$28.99	\$26.09
153981 Craftsman 21833	\$31.99	\$28.79
832209 Craftsman vintage	\$30.99	\$27.89
152650 Craftsman older	\$29.99	\$26.99
147751 PM 2000 blade	\$38.99	\$35.09
147752 PM 2000 dado	\$39.99	\$35.99
832212 General Int'l 50-220, Jet Workshop Saw 708100, JPS-10 Pro-Shop Saw 708482, 708483, 708480K	\$28.99	\$26.09
150665 Hitachi zero clearance	\$27.99	\$25.19
149010 Jet Deluxe Exacta	\$32.99	\$29.69
149011 Jet Dlx. Exacta Dado	\$34.99	\$31.49
160629 Jet PROSHOP blade	\$27.99	\$25.19
160630 Jet PROSHOP dado	\$27.99	\$25.19
832215 Ridgid TS3650	\$29.99	\$26.99
152583 Ridgid TS2400-1	\$27.99	\$25.19
152584 Ridgid R4510 blade	\$27.99	\$25.19
153851 Ridgid R4510 dado	\$26.99	\$24.29
153117 Ridgid R4512	\$27.99	\$25.19
153118 Ridgid R4512 Dado	\$29.99	\$26.99
149416 Steel City 35900	\$31.99	\$28.79
149417 Steel City 35900 Dado	\$32.99	\$29.69

Phenolic High Pressure Laminate Stock

Perfect for creating your own custom router plates, jigs, clamping fixtures and many other types of shop accessories to your design. Sheet stock material is 1/2" x 11" x 15".

158135 1/4" thick, nominal 11" x 15"	\$18.99
158137 3/8" thick, nominal 11" x 15"	\$25.99
123033 1/2" thick, nominal 11" x 15"	\$27.99
158136 3/4" thick, nominal 11" x 15"	\$29.99

Technical Questions?

Call 1-800-535-4486
For FREE help, and advice!



Power Tool Accessories

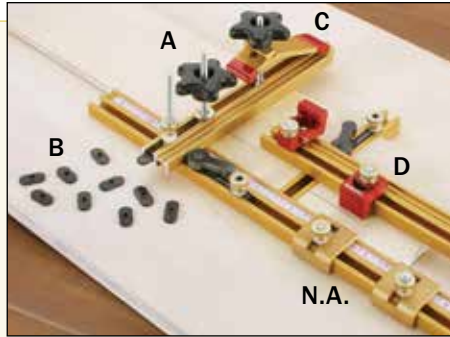

T-Track Accessories

These T-Track accessories will complement any 1/4" T-Track that accepts standard 1/4" bolt heads.

12-Piece Plastic Knob Kit includes 4 each: 3" all-thread 1/4" bolts and matching large plastic knobs and steel washers.

147918 (A) \$9.99

16-Piece Knurled Thumb Nut Kit features knurled thumb nuts and includes 4 each: 3" all-thread 1/4" bolts and matching steel knurled thumb nuts, steel washers, and nylon spacers.

147919 \$9.99

Oval Nut 10-Pack includes either #10-32 or 1/4"-20 oval nuts that are 7/16" wide (like a 1/4" bolt head), but unlike a conventional nut the thinner oval nut will slide easily in low-profile 1/4" T-Track.

147921 (B) #10-32, 10-pcs..... \$4.99

147922 (B) 1/4"-20, 10-pcs..... \$4.99

Deluxe Hold-Down Clamp. Better than normal hold-down clamp, this version has rubber tipped ends to increase grip on both surfaces and reduce denting of your workpiece.

142603 (C) \$10.99

Single Molded Flip Stop for accurate repeatable functionality.

154277 (D)..... \$9.99



INCRA T-Track And T-Track Plus

Add accuracy and precision to your jigs and fixtures with T-Track and T-Track Plus from Incra. These tracks are designed with a host of enhancements. Like other tracks, the extruded anodized aluminum construction is designed to house a 1/4"-20 bolt head, but that's where the similarity ends. First, these tracks feature a "well" in the extrusion allowing the track to be mounted using the included #8 panhead screws versus #6 flathead screws used by other tracks. The extra depth of the "well" allows the use of 1/4"-20 nuts that are not accommodated by other tracks. On the T-Track Plus there is the addition of a highly accurate Lexan scale that can be moved to a "zero" reference. The T-Track is sized for a 3/4"-wide opening; the T-Track Plus fits a 1 1/4" wide opening.

142803 (A) 18" T-Track \$10.99

142804 (A) 24" T-Track \$11.99

142805 (A) 36" T-Track \$15.99

142806 (A) 48" T-Track \$19.99

142580 (B) 18" T-Track Plus..... \$11.50

142581 (B) 24" T-Track Plus..... \$14.99

142582 (B) 36" T-Track Plus..... \$17.99

143218 (B) 48" T-Track Plus..... \$22.99

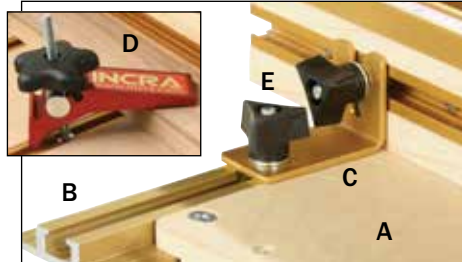

INCRA Build-It System For Jigs & Fixtures

Quickly and easily create a wide variety of common and special purpose jigs & fixtures that you typically find hanging on the walls and rafters in just about any woodshop. The highly versatile INCRA Build-It modular jig & fixture platform system begins with MDF Base Panels that are pre-cut and pre-drilled to instantly accept all of the components of the system. Add a Miter Slider in seconds, and it's automatically square to your saw blade with no tedious measuring or drilling. Then mount a fence in moments using the counter-bored mounting holes. The innovative T-slot Panel Connectors are specially designed aluminum components that simultaneously interconnect the panels and provide a rock solid T-slot for adding and holding jig accessories, fences, stops, Incra Hold-Down Clamps and INCRA L-brackets. With the Build-It system, you just connect the parts with a screwdriver and the included fasteners. Starter Kit includes one each of the small & large MDF Base Panels, 18" Miter Slider, Hold-Down Clamp, L-bracket pair, 1/4"-20 Knob Kit, 18" T-Track, 18" T-Track Plus and two 18" T-slot Panel Connectors. Plus 5 free jig plans!

148117 (A) MDF base panel, 7 3/4" x 15 1/2" \$15.99

148118 MDF base panel, 11 3/4" x 15 1/2" \$18.99

148119 (B) T-slot panel connector, 18" .. \$21.25

148120 T-slot panel connector, 24"..... \$26.25

148121 (C) L-bracket (set of 2) \$12.50

148122 (D) hold-down clamp \$13.99

148123 (E) 1/4"-20 knob kit (set of 4)..... \$12.50

14V59 INCRA Miter Slider, 18"..... \$19.99

129795 INCRA Miter Slider, 24" \$24.99

148541 Build-It system starter kit \$140.99

Power Twist Link Belt

Reduce vibration in any of your belt driven machines. Power Twist Link Belt is 1/2" wide, easily adjustable. Includes instructions for use.

145530 4' length..... \$44.99



INCRA Miter Sliders

Eliminate the tedious process of making, fitting and adjusting the wooden runners on your sliding table saw jigs. Just screw these special extruded aluminum runners to your jigs and you're ready! Miter Sliders have unique expansion mechanisms in their body that perfectly adjust to any standard 3/4" x 3/8" miter gauge slot. Each Slider includes plans for building a variety of table saw jigs. Sold individually.

Each 4+

14V59 18" slider \$19.99..... \$17.99

129795 24" slider \$24.99..... \$22.49

INCRA Miter Slider SE is a steel miter bar like the Glide Lock miter bar found on INCRA miter gauges. Sold individually.

149882 18" steel slider SE..... \$27.99

149883 25 1/2" steel slider SE... \$37.99

INCRA Miter Channel

Why trust the operation of your Incra Miter Gauge or Miter Slider in just any miter track. Each channel is constructed of hard anodized aluminum for durability with Incra's trademark gold finish. Mounting is easy with pre-drilled holes and included fasteners; simply cut a 1 1/8" wide, 1/2" deep groove in your table or create a laminated fixture using 1/2" thick material on either side of the channel. The "T-slot" design can be used in conjunction with hold-downs and will work with any standard 3/8" x 3/4" miter bar. Add versatility to Incra Miter Channel as well as most power tool miter gauge slots. The kit includes: (4) knobs, (4) steel washers, (8) nylon washers, (4) 2" bolts and (4) unique T-slot nuts.

145709 32" miter channel \$17.50

145710 48" miter channel \$22.99

Miter Slot Nut Kit

Add versatility to Incra Miter Channel with this kit which includes: (4) knobs, (4) steel washers, (8) nylon washers, (4) 2" bolts and (4) unique T-slot nuts

151088 4-pack miter slot nut kit \$19.99

Momentary On/Off Deadman's Switch

Perfect for any scrollsaw! This momentary switch provides quick, vcontrol-able starts and stops. Keeping both hands on the work allows you to be in complete control and work more safely while sawing. Just press the switch with your foot for "on" and lift your foot for "off".

147876 \$24.75



Foot Switch - On/Off

Turn tools on and off while performing tasks that require both hands. Just plug your tool into the footswitch and use its generous 7' cord to locate the switch in a convenient position. Great for scroll saws, power carving tools and other 115 Volt tools up to 15 amps. Features large 3 1/2" x 6 1/4" pedal for easy use.

145968 \$31.49



Magnetic Planer Knife Setting Jigs

These economical jigs allow you to install and adjust planer knives quickly and accurately, saving you both time and frustration. Magnets hold both the jig to the head and the knife to the micro blade adjusters. Set your knives to a tolerance of ± .002" in minutes! Each set includes two jigs, case and instructions. Large jig fits planers with head diameters of 3" to 5"; small jig fits planers with head diameters of 1 7/8" to 3".

145256 large jig set..... \$54.99

145729 small jig set \$59.99



UHMW Sheets

Perfect For Precision Jigs And Fixtures!

A tough, heavy, dense plastic with self-lubricating properties, this Ultra High Molecular Weight material is great at reducing material to fence friction on router table fences or auxiliary table saw fences. UHMW is easily machined so it can also be used for table saw runners, router templates or any project component where friction is a problem. Sheets are 4" x 48".

124225 1/8" thick.....	\$12.99
124226 1/4" thick.....	\$21.99
124227 1/2" thick.....	\$29.99
124228 3/4" thick.....	\$39.99

Slick Strips

Reduce Friction

To the point where almost everything moves like it's mounted on ball bearings! This special UHMW (Ultra High Molecular Weight) adhesive-backed flexible plastic film has a low coefficient of friction and a high abrasion resistance that surpasses even Teflon™. The 3" width is ideal for use on power tool fences and provides a slick, mar-free surface for router bases and wear plates of portable circular saws. The 3/4" width is perfect for renewing the smooth run of worn wooden drawers. 10.5' rolls are easily cut to length.



	Each	3+
16164 3/4" width.....	\$8.50	\$7.65
16165 3" width.....	\$23.99	\$21.59

HTC Deluxe Tool Table

The HTC Deluxe Tool Table is constructed of heavy-gauge steel and features an expandable 14" x 25" x 3/4" MDF top with a handy ruler imprinted on the surface. This table also features an 18" x 27" x 3/8" MDF lower shelf, rubber feet for nonskid support and a tough, powder-coat finish. Working height of 31" and 500-lb. capacity.



151044**\$69.99**

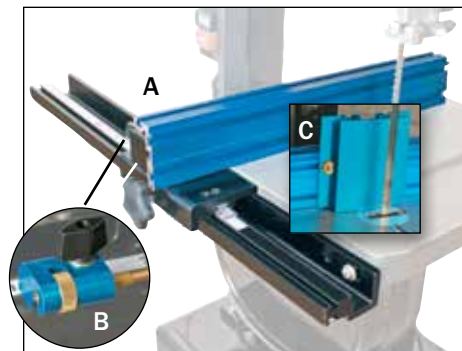

KREG®

Precision Bandsaw Fence

Introduce a new level of accuracy to your bandsaw with this precision fence. The rigid aluminum extrusion guarantees strength and stability, and is adjustable in two dimensions so you can set this fence parallel to the blade both vertically and horizontally. Cutting accuracy and repeatability are further enhanced by the precision lens cursor that reads off of the included scale. Fits most 14" bandsaws, mounting hardware and instructions included. Optional Micro-Adjuster for ultra fine fence adjustments.

146050 (A) fence.....	\$107.99
146053 (B) micro-adjuster.....	\$15.99
146051 (C) 4 1/2" resaw guide.....	\$18.99
146052 (C) 7" resaw guide.....	\$21.99

In A Hurry?

We can ship your order
Next Day or Second Day Air!
See Ordering Information for details.



Jig And Fixture Knobs And Handles Steel plated studs and brass threaded inserts assure strong, reliable holding power. Plastic molded knobs provide a comfortable grip.

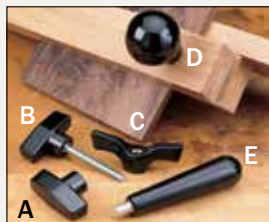

T-Style Knobs, phenolic, with insert.

	Each	4+
85J95 (A) 1/4"-20 ...	\$1.75	\$1.57
142226 (A) 5/16"-18..	\$1.75	\$1.57
142227 (A) 3/8"-16 ...	\$1.75	\$1.57

T-Style Knob with 2" stud.

27R16 (B) 1/4"-20 **\$2.50** ... **\$2.25**

Wing Knobs replace metal wing nuts and allow incredible torque. Phenolic 3" diameter, with a 3/8"-16 insert.

85J94 (C) **\$2.09** ... **\$1.88**

Ball Knob, great for low profile jigs. 1 3/4" diameter with a 3/8"-16 insert.

27R17 (D)..... **\$3.50** ... **\$3.15**

Tapered Handle is easy to grip. 3 3/4" high, 1" diameter with 3/8"-16 x 3/4" stud.

27R18 (E) **\$3.50** ... **\$3.15**

Miniature Knob. Nylon 3/4" dia. x 9/16" knob with 1/2" long 10-24 steel stud.

27R11 (F) pair..... **\$2.50** ... **\$2.25**

Four-Arm Knob with brass insert is easy to grasp for sure tightening in awkward positions. Phenolic 2" dia. x 1" height.

Each 4+

27R14 (G) 1/4"-20.. **\$3.25** ... **\$2.93**

142228 (G) 5/16"-18 **\$3.50** ... **\$3.15**

142229 (G) 3/8"-16 **\$3.19** ... **\$2.87**



Each 4+
Four-Arm Knob with 1 1/2" stud.

27R15 (G) 1/4"-20.. **\$3.99** ... **\$3.59**

142906 (G) 5/16"-18 **\$3.25** ... **\$2.93**

142907 (G) 3/8"-16.. **\$3.25** ... **\$2.93**

Four-Arm Knob with through hole.

142230 (G) 1/4"-20.. **\$2.50** ... **\$2.25**

142231 (G) 5/16"-18 **\$2.09** ... **\$1.88**

142232 (G) 3/8"-16.. **\$2.09** ... **\$1.88**

Five-Star Knob with through hole. Versatile ABS polypropylene 2 1/4" dia. knob with "through" steel insert allows it to travel any distance on a threaded rod or bolt.

27R13 (H) 1/4"-20... **\$1.75** ... **\$1.57**

142224 (H) 5/16"-18 **\$1.75** ... **\$1.57**

142225 (H) 3/8"-16.. **\$1.99** ... **\$1.79**

Ratchet Multi-Position Handle. Move the handle to any position so it doesn't interfere with your work, or use it for those "tight" places where full turns are not possible. 2 1/2" nylon handle, height 1 7/16", with 1" long 5/16"-18 steel stud.

129131 (I) **\$4.99** ... **\$4.49**

129132 (I) stud..... **\$5.50** ... **\$4.95**

(J) Ergo Style Knobs. Ergonomically designed for comfort and strength.

146910 1 5/8" D, 1/4" x 20 **\$2.09**

146911 2 3/8" D, 5/16" x 18 **\$2.09**

146912 2 3/8" D, 3/8" x 16 **\$2.09**



Specialty Jig And Fixture Hardware

A collection of every accessory that you need to build the kind of jigs and fixtures that increase accuracy, efficiency, and safety in your woodworking shop.

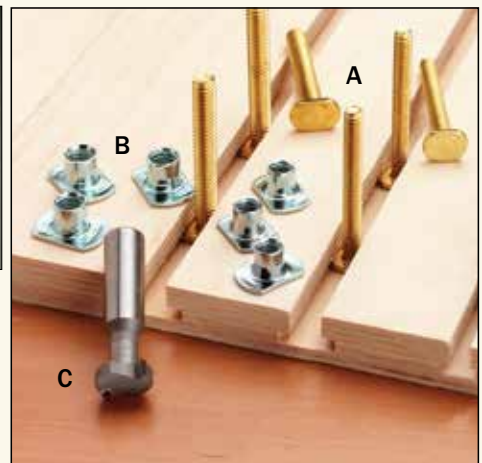

(A) T-Bolts. Standard "toilet bolt" design, the 1/4"-20 bolts will slide easily into the small T-Slot groove. The 5/16"-18 will slide into the medium T-Slot groove. Sold in packs of 10.

130435 1/4"-20 x 1 3/4" **\$7.99**

130436 1/4"-20 x 2 1/4" **\$7.99**

130437 1/4"-20 x 3 1/2" **\$10.50**

130438 5/16"-18 x 2 1/4" **\$12.50**

130439 5/16"-18 x 3 1/2" **\$12.50**

(B) Sliding T-Nuts sold in packs of 10.

130440 1/4"-20 **\$1.99**

130441 5/16"-18 **\$2.50**

130442 3/8"-16 **\$2.50**

(C) WHITESIDE Special T-Slot Router Bits are designed to make easy work of creating your own professional woodworking jigs and fixtures. The Small T-Slot measures 5/8" W and 3/16" H at the base with a 1/4" shank. It requires the cutting of a 1/4" straight groove, with a router bit or dado blade, prior

to routing the "T". The Medium T-Slot measures 3/4" W and 3/16" H at the base with a 1/2" shank. It requires the cutting of a 3/8" straight groove prior to routing the "T". Both are carbide tipped, made in the USA.

128256 small t-slot..... **\$24.99**

128257 medium t-slot..... **\$26.50**

Straight Bits, for cutting straight grooves. 1/4" dia. bit has a 3/4" cutting length and 1/4" shank. 3/8" dia. bit has a 1" cutting length and 1/2" shank.

24A04 1/4" dia..... **\$14.99**

24A33 3/8" dia..... **\$18.49**

(D) Cam Action Hold-Down lets you build quick action clamping into your special jigs, fixtures or fences. Comes with a 3 1/2" x 5/16" x 18 tpi T-bolt, steel and nylon washers. The 1 1/2" long lever is large enough to easily grip yet small enough to not interfere with your jig.

145630 **\$7.99**

Power Tool Accessories



CARTER Bandsaw Guides

Here's an upgrade that turns an ordinary bandsaw into an extraordinary bandsaw! These easy to install kits provide significant improvement in saw performance through more consistent blade tracking and reduction in blade friction. Bearings are fully sealed and lubricated and the easy to adjust all ball bearing guides eliminate the necessity of "side bearing blocks". Carter guides adjust for blades from 1/8" to 1" in width and are ruggedly built for long lasting durability. Each kit includes all mounting hardware and complete instructions. Fits round guide support shafts only. Hex shank model for old saws is available as a special order item.

812766 for Jet 14" bandsaw\$179.99

812765 for Delta 14" bandsaw\$179.99



CARTER AccuRight®

Universal Circle Cutting Jig

Cut circles up to 4+ feet diameter with your bandsaw. The jig attaches quickly and easily to the Carter MAGFENCE or saws without the MAGFENCE with the universal attachment bracket. No drilling or external mounts necessary. Circle thickness limited only by bandsaw resaw capacity. Jig includes easy to read diameter measurements for precise circle size. Use with any blade guide, block or bearing.

149941\$79.99

CARTER Urethane Bandsaw Tires

Even under occasional use the tires on bandsaw wheels periodically need to be replaced. Unlike rubber tires, which are cumbersome to replace, these slip on without any special tools, messy adhesives, or excessive downtime. Simply heat in hot soapy water and stretch this tire on to the wheel and the bandsaw is ready to use. Urethane tires also offer better performance and enhanced durability. Each package contains one tire and is sized according to the wheel diameter of the saw. The tire may be trimmed for width.



819402 10" bandsaw, 7/8" wide \$21.99

144968 12" bandsaw, 7/8" wide\$23.99

144969 14" bandsaw, 7/8" wide\$25.99

144970 16" bandsaw, 1 1/2" wide..... \$35.99

144971 18" bandsaw, 1 1/2" wide \$36.99

146153 clean sweep brush\$9.99

JessEm® Clear-Cut TS™ Table Saw Stock Guides

Clear-Cut TS™ Precision Stock Guides for Table Saws are the ultimate hold-down on the table saw. Multiple featherboards are required to simultaneously hold down and guide material accurately against a table saw fence. Clear-Cut TS Stock Guides operate on the same principle as a stock feeder in that the stock is guided at a slight angle as it is fed forward. Urethane tires on rollers with one-way needle bearings are mounted at an angle to effectively steer your stock toward the fence. Stock is pushed tightly against the fence, and the gripping force of the rollers assists in preventing kickback. All the while the roller arms work under spring pressure to ensure your material is held firmly against the table saw surface.

Like all products offered by JessEm Tool, the Clear-Cut TS Stock guides are a marvel of engineering. Components are machined from solid aluminum and



anodized for appearance and durability. The roller axles are CNC machined from cold-rolled steel and case-hardened for toughness. The adjustment bar and spring retainer are machined from stainless steel for corrosion resistance. The rollers are CNC machined from wear resistant acetal resin, which also has a low coefficient of friction. The traction tires are molded out of urethane for long life and superior grip on all materials. Guides have 3 1/8" of total vertical travel and can be positioned anywhere along the HD T-Track. Maximum stock thickness equals the distance from table saw surface to 13/16" above T-Track mounting surface. Compatible with most T-Style commercial table saw fences using the included HD T-Track. Includes two adjustable roller arm assemblies, fence mount HD T-Track, mounting hardware and detailed instructions.

159902 \$249.99



CARTER MAGFENCE® II Universal Magnetic Fence

The Carter Products MAGFENCE® II magnetic fence quickly fastens to most steel or cast-iron tables, regardless of size, because there are no brackets or mounts required to attach the fence to the table. The 16' long, 3 1/2" tall fence is just as easily positioned, or removed, using the two powerful, switchable magnets for fast setup on power tools and making precision adjustments. Perfect for use with your bandsaw, drill press, spindle sander or nearly any tool with a ferrous metal surface. L-shaped aluminum extrusion contains multiple T-slots to attach most standard T-slot fixtures and is compatible with all MAGFENCE® II accessories.

153477 \$104.99

Cobra Coil Bandsaw Tension Spring

The tensioning spring on a bandsaw will weaken over time, especially on saws that have had high tension "dialed-in" for resawing. The Carter Cobra Coil will restore the tension available for resawing and may even improve the performance of new machines. This spring will produce over 10,000 PSI of blade tension even on machines equipped with riser blocks. The Cobra Coil fits Delta, Jet and most imported 14" bandsaws.



144967 \$24.99

Cool Blocks™ Bandsaw Blade Guide Blocks

Made from a specially formulated graphite impregnated phenolic laminate, Cool Blocks are self-lubricating, enabling them to withstand the heat generated by blades running at high speeds. Eliminate the blade damage that occurs when teeth contact the metal blocks. Pack of 4 blocks to fit upper and lower guides.



Saw Type	Approx. Block Size	
49H01	Delta 14" 1/2" x 1/2"\$16.99
49H07	Delta 8" & 10" ... 3/16" round\$15.99
49H02	imported 14" 1/2" x 1/2"\$16.99
49H03	Sears 12" 3/8" x 3/8"\$16.99
49H06	old Sears 1/4" round\$16.99
49H05	Shopsmith 11" ... 3/8" x 3/8"\$16.50
144530	9" 2-wheel 13/64" x 13/16", 13/64" x 1"\$16.99
144531	Delta 12", 16", Jet 12" 5/16" x 3/4"\$16.99
144532	imports 12mm (.472") round\$16.99

WoodRiver® 4-Sided Corner Radius Template

Cut perfect corners every time with this simple, but very useful MDF Corner Radius Template. Made from 1/25" MDF, this jig has four radii on one board: 1", 2", 3" and 4" radii. All you need are double-stick tape, a pattern bit and a router. Making your own repetitive corners has never been easier! Simply trace out the radii using the templates, and rough-cut them. Then, using double-sided tape, templates and a router with a flush-trim bit, trim your project to the final dimensions.



159913 \$10.99

WoodRiver® Guide Rail System

This system will allow you to place a tool guide for ripping, crosscutting or routing at an acute angle on any size panel. The base component **56" Guide Rail** features the same heavy-duty aluminum extrusion used in the **WoodRiver® Clamp Guides** with integral 1/4" T-tracks and 2 1/8" x 1/2" profile. The **Guide Rail Connector** locks together multiple guide rails to form a continuous guide for your circular saw or router across any length material. Pairs of clamps are sold separately to secure the guide rail at each end. These clamps swivel about the "T" shaped anchor and can be placed at any position along the underside of the guide rail extrusion. **Universal Base for Routers and Saws** slides accurately in the T-slot found on all WoodRiver® Clamp Guides and WoodRiver® Guide Rails. Perfect for mounting your circular saw or router to create a precision power tool accessory.

- 150002 (A) 56" guide rail component.....\$24.99
- 150003 (B) guide rail connector.....\$18.99
- 150004 (C) pair of guide rail clamps.....\$28.50
- 149196 univ. base for routers & saws....\$31.50

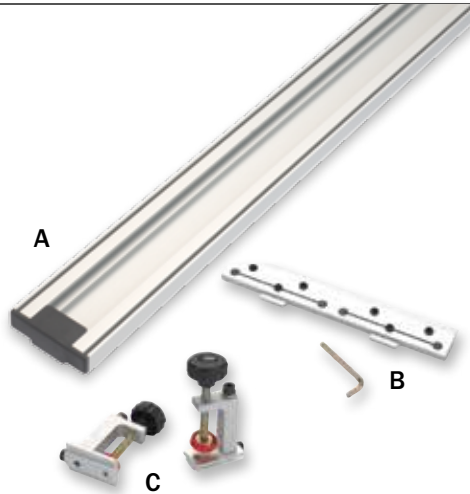

Woodpeckers® Complete Drill Press Table

Woodpeckers Drill Press Table features a generous 16" x 23" x 1" tabletop constructed of an MDF core covered with Formica Micro-Dot laminate – a unique texture which is a grid of small dimples that collect sawdust, allowing the surface to better "grip" the workpiece under pressure. A removable insert minimizes tear-out when drilling through material, eliminating the need for a "backer board." Each T-track is permanently laser engraved with an easy-to-read, high contrast scale that clearly indicates fence position. The 36" fence uses the same double-wide track as the table to give you more stop and accessory mounting options. Complete Drill Press Table includes all T-tracks, two Flip Stops, two Hold-Down Clamps and mounting hardware. Accessorize your Drill Press table with the 3" x 3" x 23 1/2" L-shaped DP3 Fence or multi-position molded Knuckle Clamp, each sold separately. Made in the USA.

- 154278 complete drill press table.....\$134.99
- 154277 additional molded flip stop.....\$9.99
- 142603 additional hold-down clamp.....\$10.99
- 154292 DP3 tall drill press fence.....\$79.99
- 154293 single knuckle hold-down clamp\$19.99

WoodRiver® 14-LED Drill Press Light

Every drill press naturally casts a shadow on your workpiece, making an extra light a safety necessity. Innovative LED lighting offers the best solution. By attaching it to the drill press quill it becomes an efficient, convenient light. 14 white light LEDs are arranged in a circular housing that attaches to drill presses with quill diameters 1 5/8" to 3 7/8". A strong magnet fixes the switch to any steel or cast-iron surface, with power supplied by a wall transformer.

- 153119\$41.99



Accessory Power Switch

This is an economical 15-amp switch, designed for use with scroll saws, sanders, lathes, router tables, or any bench-top tool application. The switch includes a 5 1/2' grounded cord with a 3-pin end and a 3-pin receptacle above the switch. A large paddle switch with removable child protective lock is easy to locate and turn the tool off. The housing is constructed from high impact plastic and the switch's rear plate is made of heavy gauge steel with mounting tabs at the top and bottom.

- 145199\$29.99



Quick Set Drill Press Hold-Down

This hold-down post quickly mounts to most drill press tables that has slots or holes. A bolt passes through the table and is secured with a large ring nut. To adjust the height for up to 5" of capacity, simply depress the clutch (similar to a pipe clamp) and slide the clamp head to the desired setting. Hold-down pressure is provided by the cam-action clamp on the head which features a 1 1/2" diameter rubber foot to help prevent marring your workpiece.

- 145969\$20.99
- 147827 (A) large clamp pad.....\$3.99

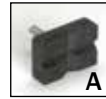

HTC Portamate Adjustable Pedestal Roller Stand

The Portamate pedestal roller solves many woodworker's needs for stable support and freedom of movement when using larger workpieces. Easy to assemble, it will fold flat for convenient storage. Nonslip rubber feet and a wide stance ensure stability. With height adjustment from 27 to 43 3/8", it is ideal for use with table saws, drill presses and other shop machines. 132-lb. load capacity.

- 159010\$31.50



HTC Portamate Tri-Function Adjustable Roller Stand

Tri-Function Adjustable Roller Stand is a pedestal work support stand with three head positions. The pivoting head provides three types of work support: rolled metal flange for stationary support, premium polished steel 1 1/4"-wide ball bearing roller for straight infeed or outfeed support and six steel roller balls for 360° freedom of movement. Height is adjustable from 27" up to 43 3/4" on a wide stance with nonslip rubber feet, folds flat for easy storage, and supports up to 200 pounds.

- 154574\$31.99



NEW



HTC Portamate Panel Carrier PM-1800

Ingenious design allows for easy moving of unwieldy sheets of plywood, MDF and more 350-lb. capacity with 2-1/4" bottom lip on support arm, wide enough for 2-3 sheets at a time. Bottom support leg locks into place, giving you the stability you need for loading and unloading. Support arm tilts and locks horizontally and is adjustable from 28" to 40" height. Lock the support arm at 90° for a stable table saw feed stand.

- 161784\$109.99

HTC Machine Covers

These HTC covers are of a strong, durable cotton sheeting that is skip-coated with a special water-resistant plastisol that breathes so condensation doesn't collect. The covers have rolled hems with a rubberized magnet sewn into each corner.

- 143838 small, 27" x 36"\$14.99
- 143839 medium, 36" x 56"\$19.99
- 143840 large, 56" x 72"\$34.99
- 159011 3-pc. set: sm., med., lg.\$64.99
- 143841 jumbo, 72" x 112"\$49.99



Power Tool Accessories

WoodRiver®

Adjustable Mobile Base

The WoodRiver® Adjustable Mobile Base will make it easier to move your tools, enabling you to get the most out of your existing space. The stable 4-wheel design features all steel construction with a 400-lb. capacity. The frame adjusts in 1" increments to easily expand from 12" to 50". Minimum size is 12" x 12", maximum square is 34" x 34", and maximum rectangle is 18" x 50". Step on the foot-activated metal cam levers, roll your tool into position, and then lower the tool to rest firmly on the adjustable rubber leveling feet.



148515 **\$85.99**

WoodRiver®

Universal

Mobile Base Hardware Kit

This kit provides the components to assemble a universal mobile base for your machine or tool stand using your plywood or similar panel cut to size. Made of heavy-gauge steel, once assembled the mobile base can support up to 600 lbs. and accommodate a 12" x 12" to 36" x 36" machine. The four mobile base corners are adjustable for different plywood thicknesses from 3/4" to 1 1/2". Features two convenient, foot-operated pedals to raise the base onto casters or lower the base onto adjustable levelers. Two sturdy swivel casters and two fixed casters provide maximum mobility. Includes hardware for panels of 3/4" thickness and instructions for assembly.



152711 **\$64.99**



FastCap Mag Shims

Mag Shims are the easiest way to set your blade height and fence spacing on your table saw. Simply stick the magnetic shims together to get a perfect setup in seconds! Mag Shims are also great for setting depth on drill presses. Standard spacing 1/16" to 1 1/8". Very handy for setting router depth or spacing for layout projects. Includes eight 1/8" shims and two 1/16" shims.

860845 **\$24.95**

Ball Bearing Work Rollers

Unlike rollers which operate only in a straight line, these 360° universal transfer bearings excel where shop materials are pushed and turned in all directions. Make up your own outfeed tables for saws (great for bandsaws), finishing tables, assembly lines and more! Rollers have 5/8" or 1" hardened steel balls rotating on 1/8" dia. internal bearings. Load rating of 75 lbs. each.



	Diameter	Each	6+
07B09	5/8"	\$3.19	\$2.87
07B08	1"	\$4.19	\$3.77



HTC Universal Mobile Bases

HTC Universal Mobile Bases feature side rails and corner pieces with holes spaced every 1" to insure the perfect fit to your machine. All parts are included in this stable 4-wheel design that increases machine height by less than 1". Foot operated levers lock machines to the floor. The heavy-duty **Model PM-1000** assembles to a minimum square of 12" x 12", maximum square of 34" x 34", maximum rectangle of 18" x 50" and supports machines up to 400 lbs.

150782 PM-1000 **\$62.99**

Retracting Casters For Contractor Style Saws

Put your open base saw on wheels with the touch of a toe! Unlike mobile bases, these casters do not change the height of your saw. When the casters are retracted your saw sits solidly on its own legs. The swiveling wheels fit most open base saws. Set of four; all mounting hardware is included. On some saws, drilling may be required for the mounting hardware.



141550 **\$49.99**

WoodRiver®

LED Shop Light With Magnifying Glass Head

This WoodRiver® 7-LED Dual Power Shop Light can go anywhere in your shop and is excellent for providing task lighting. Great for scroll saws, band saws, drill presses, reading and just about anything else you can think of. A very strong magnet permits application to any steel or iron surface or clamp it on any surface up to 2 1/2" in thickness. Perhaps the greatest feature about this light is the 10" gooseneck that can be bent in any direction and stays where it's pointed! The WoodRiver Dual Power Shop Light has a 4", 3x magnifying glass lens, with 14 evenly spaced LED's for lighting to see finest details.



150159 **\$44.99**

Router Base Plate With Centering Pin

This unit is pre-drilled for all the routers listed below and includes a unique centering pin for guide to the router collet centering. Simply install a Porter-Cable style guide, use the centering pin to line up the baseplate concentric to the collet, install your bit.



Fits the following models: Sears Models 315.275 000-100-110, 315.175 070-040-050-060; Ryobi; Makita 3612 and 3621; Milwaukee 1615/1616/1619 series; Hitachi; Bosch 1615 and 1617/1618 series; DeWalt DW616/618 series, DW621, and DW625; Fein FT-1800; Elu 177; Porter-Cable 690 series, 7529, and 8529; and Freud FT2000E. Complete with screws and installation instructions.

144931 **\$29.99**

MILESCRAFT TurnLOCK™

Sign Making Jigs

Make professional looking signs, 3' to 36" long with the MILESCRAFT TurnLOCK™ sign making system. Special low profile C-clamps provide secure clamping without obstructing router operation. Re-designed end caps with nail holes for mounting and large surfaces for double-sided taping. Improved rails rest on work piece for improved stability and one-way fit for easier assembly. Both jigs feature TurnLock™ technology 7" universal router base plate and metal nose template guide bushings for improved durability.



SignCrafter includes: 2 1/2" horizontal character templates with letters and numbers; 3/8" core box router bit; 5/8" metal-nose guide bushing. **SignPro** includes: 1 1/2" and 2 1/2" horizontal character templates with letters and numbers; 1 1/2" and 2 1/2" vertical number templates 1/4" and 3/8" core box router bits; 7/16" and 5/8" metal-nose guide bushings.

146219 TurnLOCK™ SignCrafter **\$49.99**
147862 TurnLOCK™ SignPro **\$71.50**
148659 horizontal letter set, 1 1/2" **\$11.99**
148660 horizontal letter set, 2 1/2" **\$11.99**
149551 sign jig rout. bits, 1/4", 3/8", 1/2" **\$27.50**



Hinge-Mate™ II

Lets you accurately set hinges in minutes. Use it for doors, strike plates, boxes, or other edge routing projects. For hinges 1" - 5" long on stock up to 1 3/4" thick. Precision made of extruded aluminum with built-in clamps, hinge setting gauge, plus scales and guide pins for door and jamb mortising. Includes special 1/2" dia. carbide bit with top bearing and storage case.

06Y01 **\$239.99**
06Y03 replacement 1/2" carbide bit **\$38.50**



Butterfly Inlay Template

Make quick and easy inlay butterflies with this inlay template. Made from tough, thick acrylic for perfect fitting inlays. Seven different size butterflies from 1" x 1 1/16" to 2 7/16" x 3 3/4" for a variety of applications. Use in conjunction with our Router Inlay Set 09I16 and Double-faced Tape 15D25.

146903 butterfly inlay template **\$27.99**
09I16 router inlay set **\$48.99**
15D25 dbl. faced tape, 1" x 36 yds. **\$25.25**

KREG® Portable Precision Benchtop Router Table

The redesigned Precision Benchtop Router Table features a 16" x 24" x 1" thick MDF core top with CNC machined 9³/₄" x 11³/₄" opening to fit the new 3-ring phenolic insert plate and standard miter gauge slot. The 15¹/₂" tall steel stand has



splayed legs and lower braces for adding a shelf or enclosing the stand for dust control. The extruded aluminum fence has been upgraded with cam clamps for fast, secure fence positioning and includes adjustable sub-fences for offset jointer routing, bit guard and 2¹/₂" dust port. Includes: 1", 1³/₁₆" and 2⁵/₁₆" Level-Loc reducing rings, Level-Loc wrench, removable brass starting pin and detailed instructions for mounting your router.

158284 portable benchtop router table **\$229.99**



A



B

KREG® Precision Router Table Insert Plates & Accessories

Tough, rigid 3³/₈"-thick phenolic material allows Kreg to make a router table insert plate that won't sag even under the weight of the heaviest routers. This standard 9³/₄" x 11³/₄" size is redesigned to use the new Level-Loc Reducing Rings that install in seconds and lock in place flush every time. They make setup changes simple by allowing you to quickly swap inserts rings for different bit sizes. Three versions of the plate are available, with two plates predrilled to the most common mounting patterns for a multitude of routers. Four-hole plate for Triton will accommodate Triton routers, as well as the popular PC7518 with minor changes to enlarge the mounting hole. Three-hole plate for PC690/890 will accommodate Porter-Cable routers, as well as Bosch 1617 series and DeWalt 616/618 series. The third version comes without predrilled router-mounting holes and features alignment marks on the underside that make it easy to center and mount any router. Level-Loc reducing rings provide three bit opening sizes, 1", 1³/₁₆" and 2⁵/₁₆", and the plate includes removable brass starting pin, Level-Loc wrench and detailed instructions. Five-piece set of molded Level-Loc Reducing Rings closes the size of the bit opening in the new style router plate, as well as the older Kreg Precision Router Lift. The set includes rings with 3³/₄", 1³/₈", 1⁵/₈", and 2¹/₈" openings, plus one blank ring that you can use to create your own custom-sized or zero-clearance ring. The set also includes a molded storage tray, which is marked with the opening size, making it easy to keep the rings organized. Precision Insert Plate Levelers can be used in your own router top to create a professional level router table using the Kreg Precision Router Table Insert Plate.

- 158285** (A) Triton router plate.....**\$54.99**
- 158286** PC690/890 router plate.....**\$54.99**
- 158287** blank router plate.....**\$54.99**
- 158288** (B) 5-pc. insert ring set.....**\$24.99**
- 148873** insert plate levelers.....**\$19.99**



KREG® PRS1045 Router Table System

Easy assembly and a host of added features improve on an already great router table! The 36" Precision Router Table Fence features the same T-square style design plus a NEW micro-adjust wheel for precise setups. The outfeed anchor has been redesigned for more usable table space and easier removal. The fence uses an L-shaped aluminum extrusion with two fully independent fence faces to provide zero-clearance support. The 24" x 32" Precision Router Table Top is made from MDF covered in Easy-Slide™ Micro-Dot high-pressure laminate and includes an aluminum miter channel/T-slot that works with a wide variety of accessories. The included NEW router insert plate has three molded Level-Loc reducing rings and has been designed to mount to any router utilizing your router's base plate and easy to use template (included). The Multi-Purpose Steel Stand is adjustable from 29" to 35" in height and is powder coated for durability. The Complete Router Table includes Router Table Top, Router Table Fence and Multi-Purpose Steel Stand. Add the optional Kreg Casters Set for convenient mobility.

- 160628** Complete Router Table..... **\$499.99**
- 160625** Router Table Top..... **\$179.99**
- 160626** Router Table Fence..... **\$199.99**
- 160627** Multi-Purpose Steel Stand..... **\$149.99**
- 148166** Kreg casters set (4)..... **\$52.99**

KREG® Router Table Accessories

Precision Router Table Stop
Precision Router Table Stop takes the guesswork out of routing specific lengths for dados and tenons.

Compatible with Kreg Precision Router Table Fence and Kreg Precision Benchtop Router Table.

149971**\$23.99**

Multi-Purpose Router Table Switch
Kreg Multi-Purpose Router Table Switch mounts easily to either Kreg stand. The 125-volt, 15-amp Switch includes: two female outlets for router and dust-collection use; large On-Off lockable paddle switch; and 8' long 14-gauge power cord.

149970**\$32.99**

True-FLEX™ Featherboards

Each finger of the True-FLEX Featherboard is designed to provide a consistent and optimum pressure. Simply anchor Featherboard to the router table fence or to the table combo miter T-track. Available as single or twin pack.

- 148436** single featherboard..... **\$19.99**
- 839194** featherboard twin pack..... **\$36.99**



NEW LOWER PRICE!

KREG® Precision Beaded Face-Frame System

Beaded face-frames are a great way for you to add detail, richness, and value to your cabinetry and furniture. Kreg Tool has designed a system that will help you build beaded face-frames faster, easier, and for a lot less money than ever before. The fence system works seamlessly with the KREG Precision Router Table, however, it can be easily installed on almost any full-sized router table via the miter gauge slot. Complete system includes: heavy duty aluminum fence with integrated tape measure; zero-clearance, ball-bearing sliding base; integrated clamp and precision router table stop; 3/4" precision router table set-up bar and 1/2" dowel pin; 1/4" x 1 1/2" face-frame notching bit; 1/4" standard face-frame beading bit and instructional DVD.

150515 beaded face-frame system..... **\$379.99**



KREG® Precision Router Table Setup Bars

Make adjustments to router tables, drill presses and table saws simple and precise with uniquely design bars that straddle the bit or blade. A step on the top edge of each setup bar acts as a gauge to test the depth of your completed cuts. An extension on the end of each setup bar can be used to set fence depth of a saw blade or bit as well as setting the depth stops on a drill press or plunge router. Made of soft aluminum designed to prevent damage to your router bit or saw blade if contact is made during setup. Sizes include: 1/8", 3/16", 1/4", 5/16", 3/8", 7/16" and 1/2".

150664 **\$41.99**

KREG® Router Table Tips & Tricks with Mark Eaton DVD

Mark Eaton has a tremendous history working as an educator and expert in the woodworking community. Now Mark shares his expertise with routing and router tables with the rest of us through an incredibly educational 25-chapter DVD.

153767 **\$9.99**



Routers And Router Tables

In this collection of 20 great articles from *Fine Woodworking* magazine, *Routers & Router Tables* gathers the most up-to-date information on routers and router tables, bits and jigs, tips and techniques for router joinery, and much more.

This guide will show woodworkers the smartest route to routers for accomplishing their best work.

856046 **\$21.95**

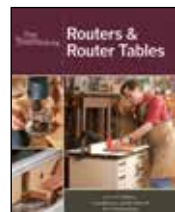

▶ CHOOSE INSERT PLATE OR ROUTER LIFT



Rout-R-Plate™
Phenolic insert plate fits most routers, fixed base or plunge. Simple solution using router's height adjustment.
153088 \$69.99



Rout-R-Lift II™
Fits 3½" diameter fixed base router motors PC690/890, Bosch 1617/1618, DeWalt 610/618. Precision adjustments. Locking spindle. Reinforced phenolic top plate.
849675 \$189.99



Mast-R-Lift II™
Fits most fixed base router motors with unique clamping system. Precision adjustments. Locking spindle. HD CNC aluminum top plate.
847824 \$363.99

▶ CHOOSE ROUTER TABLE TOP



Mast-R-Top™
Rigid solid phenolic 24" x 32" router table top with integral plate levelers and extruded miter/T-track.
153089 \$229.99



Mast-R-Lift Excel II™
HD solid phenolic 24" x 32" router table top with built-in router lifting system and extruded miter/T-track. Unique clamping system fits most fixed-base router motors. External height adjustment.
100158 \$729.99



WIXEY™ Digital Readout
Choose between display units of decimal inches, fractional inches or metric units.
153676 \$119.00

▶ ADD ROUTER TABLE FENCE



Mast-R-Fence II™
36" heavy-duty extruded aluminum router table fence with scales for position on table and position on fence, adjustable sub-fences and side-mounted T-tracks to lock fence position.
150495 \$229.99

▶ ADD OPEN STAND

Rout-R-Table™ Stand
Heavy-gauge tubular steel legs and steel stretchers. 28" x 20" x 35" high with predrilled holes for easy assembly to JessEm router table tops.
147831 \$179.99



Pow-R-Tek Switch
Switch rated at 15 Amps.
150906 \$49.99

▶ PURCHASE COMPLETE ROUTER TABLE SOLUTION



Rout-R-Plate Deluxe Router Table
Includes Rout-R-Plate, phenolic Mast-R-Top, deluxe Mast-R-Fence II and steel router table stand.
160624 \$658.96



Rout-R-Lift II Deluxe Router Table
Includes Rout-R-Lift II, phenolic Mast-R-Top, deluxe Mast-R-Fence II and steel router table stand.
153773 \$759.96



Mast-R-Lift II Deluxe Router Table
Includes Mast-R-Lift II, phenolic Mast-R-Top, deluxe Mast-R-Fence II and steel router table stand.
153217 \$923.96



Mast-R-Lift Excel II Deluxe Router Table
Includes Mast-R-Lift Excel II phenolic top with integral lift, deluxe Mast-R-Fence II and steel router table stand.
153675 \$999.99

Woodpeckers®

PRECISION WOODWORKING TOOLS

ROUTER TABLE PRODUCTS

▶ CHOOSE INSERT PLATE OR ROUTER LIFT



AI890 Router Plate
Aluminum insert plate fits most routers, fixed base or plunge with three screw mounting pattern like PC 890/690 series.
148337\$109.99



AI7518 Router Plate
Aluminum insert plate fits most routers, fixed base or plunge with four screw mounting pattern like PC 7518.
148338\$109.99



AI Triton Router Plate
Aluminum insert plate fits all Triton routers. Includes mounting holes and openings for height adjustments.
154503\$109.99



PRL-V2-420 Router Lift
Fits fixed base router motors with 4.2" diameter motor like PC7518. Precision adjustments. HD CNC aluminum top plate.
149078\$369.99

▶ CHOOSE ROUTER TABLE TOP

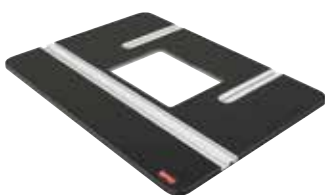

RT2432-PH Router Table Top
Rigid solid phenolic 24" x 32" router table top with extruded aluminum fence position T-track and miter/T-track.
151086\$249.99



RT2743C-PH Router Table Top
Rigid solid phenolic 27" x 43" router table top with extruded aluminum fence position T-track and miter/T-track.
151087\$349.99

▶ ROUTER TABLE FENCE



SF-36 Single Router Table Fence
Heavy-duty 36" extruded aluminum router table fence with adjustable sub-fences glides along T-tracks in WOODPECKERS' router table tops.
159485\$219.99

▶ ADD OPEN STAND



RTS 2027 - BLK Router Table Stand
Heavy-gauge steel legs and steel stretchers. 27" x 20" with predrilled holes for easy assembly. Adjusts from 36" to 42" table height.
150992\$169.99

▶ PURCHASE COMPLETE ROUTER TABLE SOLUTION



PRP-2-V2420 Router Lift Router Table

- PRL-V2-420 Router Lift - 149078
- RT2432-PH Router Table Top - 151086
- Router Table Fence - 159485
- RTS2027-BLK Router Table Stand - 150992
- Bonus Wheel Kit - 150994

159486\$1,049.99



PRP-4-V2420 Router Lift Router Table

- PRL-V2-420 Router Lift - 149078
- RT2743C-PH Router Table Top - 151087
- Router Table Fence - 159485
- RTS2037-BLK Router Table Stand - 150993
- Bonus Wheel Kit - 150994

159487\$1,169.99

Router Table Stand Wheel Kit
150994\$49.99



RTS 2037 - BLK Router Table Stand
Heavy-gauge steel legs and steel stretchers. 37" x 20" with predrilled holes for easy assembly. Adjusts from 36" to 42" table height.
150993\$189.99



LEIGH Super Jigs

offer extraordinary joint making capability at exceptional price points. Super Jigs are available in three sizes (widths), 12", 18" and 24", to satisfy the needs of every woodworker and every budget. No other jigs equal the versatility and precision of LEIGH Super Jigs. Variably spaced through and half-blind dovetails are standard on all Super Jigs. The infinitely adjustable one-piece fingers are easily positioned for any joint pattern and you're always guaranteed a half pin at each edge of the joint, regardless of board width. A crosscut fence fits on the dovetail finger assembly to become a sliding dovetail template. You can rout half-blind pin boards and tail boards at the same time, using the included two-function spacer to offset the tail board and rout complete joints in one pass. And with Super Jigs, you are not limited to one bit and one depth of cut. Just select any of the five half-blind bits available and rout half-blind joints in the depth that best suits your project. The finger assembly can also produce two sizes of box joints, $\frac{5}{16}$ " and $\frac{5}{8}$ ". The amazing joint making capability of Super Jigs is due in part to the revolutionary new LEIGH E-Bush. Very precise adjustments for fit are made easily with the E-Bush. Settings are changed using the included pin wrench, and the uniquely shaped locking nut makes tightening the E-Bush a snap. Markings clearly indicate the adjustment direction necessary for the desired change. A simple twist of the E-Bush changes its active diameter which in turn changes the fit of finger joints and half-blind dovetails. Easy to use cam action clamps and aluminum clamp bars hold the workpiece securely against nonslip material applied to each clamping surface. Includes: $\frac{1}{2}$ "-8° dovetail bit, $\frac{1}{2}$ " 14°-dovetail bit, $\frac{5}{16}$ " straight bit, $\frac{1}{2}$ " to 8mm collet reducer, sliding dovetail fence, half-blind bridge piece material, E-Bush, fully illustrated User Guide and Instructional DVD.

148134 Super 12" dovetail jig.....	\$275.00
148151 Super 12" w/acc. kit.....	\$454.00
148135 Super 18" dovetail jig.....	\$399.00
148152 Super 18" w/acc. kit.....	\$559.00
148136 Super 24" dovetail jig.....	\$489.00
148153 Super 24" w/accessory kit.....	\$644.00
148973 replacement E-bush.....	\$15.00

LEIGH Super Jig Accessory Kits include a Vacuum & Router Support (VRS) and 7-Piece Boxed LEIGH Router Bit Set. Leigh's ingenious VRS provides router support and dust-free routing. 7-Piece Bit Set features 8mm shank bits. Includes: $\frac{1}{4}$ " x 8° dovetail; $\frac{5}{16}$ " x 8° dovetail; $\frac{3}{8}$ " x 8° dovetail; $\frac{7}{16}$ " x 8° dovetail; $\frac{1}{2}$ " x 10° dovetail; $\frac{1}{2}$ " x 12° dovetail; $\frac{1}{2}$ " x 18° dovetail.

148147 Super 12" Jig acc. kit.....	\$194.00
148148 Super 18" Jig acc. kit.....	\$204.00
148149 Super 24" Jig acc. kit.....	\$204.00



LEIGH D4R PRO Dovetail Jigs

The new D4R PRO-24 jig features a one-piece aluminum extrusion base with machined-in non marring textured clamping surfaces and machined-in side stops on the top and front of the jig body. The top side stops have a $\frac{3}{8}$ " recess for rabbeted boards. Like its predecessor, the D4R easily produces handmade looking dovetail pins and tails. Perfect fitting joints for tiny boxes or large case pieces can be produced in a variety of patterns by simply changing the adjustable guide fingers. Wooden pieces are clamped into the jig quickly and easily with the cam action clamps which can be adjusted for different stock thickness in seconds, or used to repeat the same clamp tension instantly. Through or half-blind dovetails can be easily set up by simply flipping the finger assembly over. Jigs are meticulously engineered and constructed. Accepts boards up to 24" wide. Maximum pin thickness $1\frac{1}{4}$ ". Includes three carbide router bits, a $\frac{1}{2}$ " D x 8° x 8mm dovetail bit and a $\frac{5}{16}$ " x 1" x 8mm straight bit for through dovetails, and a $\frac{1}{2}$ " D x 14° x 8mm dovetail bit for half-blind dovetails. Also includes a $\frac{1}{2}$ " to 8mm collet reducer and a $\frac{7}{16}$ " template guide bushing, comprehensive instruction manual and instructional DVD.

151003 D4R-PRO dovetail Jig.....	\$594.00
148154 D4R w/acc. kit.....	\$819.00

LEIGH D4 Accessory Kit includes a Vacuum & Router Support (VRS) and 12-Piece Boxed LEIGH Router Bit Set. LEIGH's ingenious VRS provides router support and dust-free routing. 12 Piece Bit Set features $\frac{1}{2}$ " and 8mm shank bits. Includes: $\frac{1}{4}$ " x 8° dovetail; $\frac{5}{16}$ " x 8° dovetail; $\frac{7}{16}$ " x 8° dovetail; $\frac{11}{16}$ " x 8° dovetail; $\frac{13}{16}$ " x 8° dovetail; $\frac{7}{16}$ " x $1\frac{1}{4}$ " CL straight; $\frac{1}{2}$ " x $1\frac{1}{4}$ " CL straight; $\frac{1}{2}$ " x 10° dovetail; $\frac{1}{2}$ " x 12° dovetail; $\frac{1}{2}$ " x 18° dovetail; $\frac{1}{2}$ " to 8mm collet reducer.

148150	\$279.00
--------------	----------



LEIGH Finger Joint Templates

Finger joints add visually striking symmetrical design to corner assemblies. Unlike dovetails, finger joints do not interlock mechanically but their enormous glue surface area makes them as strong as dovetails throughout the life of today's modern adhesives. Leigh's versatile 24" F3 Finger Joint Template is the most comprehensive and accurate jig of its kind. The F3 produces 11 sizes of square joints from $\frac{3}{32}$ " to $\frac{1}{2}$ " and can produce three sizes of square half-blind finger joints. Leigh's unique patented E-Bush system, included with the F3, guarantees a precisely fitted finger joint every time. Add the Leigh F24 or F18 Finger Joint Template to your respective Super Jig to rout an additional six sizes of finger joints and two sizes of square half-blind finger joints. Complete with instructions.

151135 F3 for D-24 series dovetail jigs	\$209.00
---	----------



LEIGH Frame Mortise & Tenon Jigs

The mortise & tenon is the strongest and most versatile of woodworking joints. With the Frame Mortise and Tenon family of jigs and a plunge router, every woodworker can easily produce this incredible joint with unmatched accuracy and speed. All of the guides and bits used with the original are common to both jigs, allowing both FMT jigs to produce a vast array of mortise-and-tenon sizes from unbelievably small joints to massive 5" joints. Both jigs work with virtually any plunge router to produce precise, straight, double, angled and compound angled joints with sizes ranging from $\frac{1}{16}$ " x $\frac{1}{8}$ " to $\frac{1}{2}$ " x 5". As the name implies, professional woodworkers will rely on the cast and extruded aluminum construction of the **FMT PRO** with cam-action speed clamps, retractable sight and integral dust-collection system. The new **Super FMT** (shown below) incorporates the functionality of the original FMT at a fraction of the cost! The jig is constructed of heavy gauge rugged steel frame with multi-position clamping to clamp boards up to 3" x 5". Super FMT includes: universal sub-base that attaches to virtually any plunge router; two F-style clamps with 3" thickness capacity and adjustable side stop fence for tenoning. Both jigs include five $\frac{5}{16}$ " joint guides ($\frac{5}{16}$ " x $\frac{1}{2}$ ", $\frac{3}{4}$ ", 1", $1\frac{1}{4}$ " and $1\frac{1}{2}$ "); joint guide stand; $\frac{5}{16}$ " HSS spiral upcut bit with $\frac{1}{2}$ " shank; mounting hardware, and as you would expect from Leigh Industries a comprehensive illustrated user guide. The vacuum box adds to the convenient operation of the Super FMT jig, and, like the FMT PRO, includes adaptors to connect to almost any shop vacuum or dust-collection system.

822034 (A) FMT PRO jig.....	\$1,079.00
150724 (B) Super FMT jig (below)	\$544.00
150725 vacuum box for Super FMT	\$49.00
144038 $\frac{1}{4}$ " guide set (8 guides).....	\$79.00
144039 $\frac{3}{8}$ " guide set (4 guides).....	\$44.00
144040 $\frac{1}{2}$ " guide set (4 guides).....	\$44.00

Onsrud HSS Bits

03K42 $\frac{1}{4}$ " D, $\frac{3}{4}$ " CL, $\frac{1}{2}$ " D.....	\$29.99
03K43 $\frac{3}{8}$ " D, $1\frac{1}{4}$ " CL, $\frac{1}{2}$ " D.....	\$29.50
03K52 $\frac{1}{2}$ " D, $1\frac{1}{2}$ " CL, $\frac{1}{2}$ " D.....	\$37.99



Technical Questions?
Call 1-800-535-4486
For FREE help, and advice!





LEIGH

Multiple Mortise-And-Tenon Attachment
Replaces the dovetail assembly of your D4R jig to make perfect through or blind tenons, box or finger joints. Includes complete instruction booklet and 1/2" spiral cut router bit for joints 1/2" x 5/8" to 1 1/2" x 2 1/2". Jig requires 5/8" OD guide bushing to operate. For small joints to 5/16" x 5/8" a 5/16" spiral cut router bit and 7/16" OD guide bushing are required (not included).

03K55 \$269.00

Extra Bits for MMT Attachment. Two flute, spiral upcut, high-speed steel.

03K52 1/2" diameter 1/2" SH \$37.99



LEIGH

Vacuum & Router Support

The ultimate waste control and router support for your LEIGH dovetail jig - the revolutionary LEIGH VRS (Vacuum & Router Support). The router is positioned between the control arms attached to the vacuum chute below, and the arms are adjustable to suit any size router base. The vacuum chute glides effortlessly from side to side on nylon rollers and automatically follows the router when routing the joint or when the router is parked off to the side. The chute is always in the perfect position to catch the chips being thrown out by the high-speed router bit action. Chips and sawdust are drawn into the vacuum chute and down through the vacuum hose. Comes complete with two adaptors to fit all popular vacuum hose sizes from 1" to 2". Can be used with a small shop vacuum or large dust-collection system. Easily attach and use on any LEIGH Jig without jig modification. All mounting hardware is included.

148141 for D4R PRO-24, 24" dovetail jig \$109.00

148139 for Super 24" dovetail jig \$96.00

148138 for Super 18" dovetail jig \$96.00

148137 for Super 12" dovetail jig \$86.00

WHITESIDE Brass Setup Gauges & Precision Guide Bushings

perform a variety of functions, from setting depth of cut on a plunge router to setting bit height or fence depth on the router table. Stack them together to combine measurements from 1/8" to 1 1/16". Brass gauges will not damage tool or bit edges. Set includes: 5 bars, measuring 1/8", 3/16", 1/4", 3/8", and 1/2" square.

144932 2 1/2" long gauges \$13.99

836311 4" long gauges \$19.99

147853 7/16" OD bushing \$16.99



LEIGH

RTJ400 Router Table Jig System

Leigh's RTJ400 Router Table Dovetail Jig is designed specifically for router table use. The RTJ400 offers fast and accurate routing of through dovetails, box joints and half-blind dovetails on your router table. The Leigh template is precision CNC machined from aircraft grade aluminum for perfect joinery every time. Versatility is a key feature of the RTJ400.

PORTER-CABLE 12" Dovetail Jig

Model 4210. If you've put off cutting dovetails with your router because of the complicated set-up of dovetail jigs, wait no longer. Porter-Cable's new 12" dovetail jig will have you up and cutting dovetails in minutes. This jig is designed with patented alignment lines and a router bit depth stop so set-up is easy. Simply adjust the template so the alignment marks line up with your workpiece, set your router bit depth according to the depth stop, and start routing. This jig will cut half-blind dovetails, rabbeted half-blind dovetails, and dovetail dadoes. The heavy-duty cam-type clamps with sandpaper-backed locking bars provide a solid grip for the wood. The template is CNC machined aluminum to provide superior accuracy. Handles stock 1/4" to 1 1/8" thick up to 12" wide. Includes: half-blind/dado combo template, 7° carbide dovetail bit with 1/2" shank, template guide and lock nut.

146048 D/S \$124.99

Deluxe Model 4212. All the features of the model 4210 PLUS through dovetails and box joints with an



additional CNC machined aluminum template. Includes Model 4210 components plus: through dovetail/box joint combo template, 1/2" shank carbide-tipped straight bit, second template guide and lock nut.

146049 \$184.99

Through Dovetail & Box Joints Template, allows for 1/2" through dovetails and box joints. Includes 3/8" template guide and lock nut, 13/32", 1/2" shank carbide tipped straight bit.

831157 model 4213 \$79.99

Miniature Template Kit, allows for miniature half-blind dovetails, through dovetails, and box joints. Includes 3/8" & 5/16" template guide and lock nut, 9/32", 7° dovetail bit, 3/16" straight bit, small left and right offset guides.

830583 model 4215 D/S \$86.99

Replacement Bits from Whiteside.

146433 17/32" D x 7° dovetail, 1/2" SH \$23.49

148965 17/32" D x 7° dovetail, 1/4" SH \$23.49

146432 13/32" D x 1" CL straight, 1/2" SH. \$18.99

146434 straight + dovetail set, 1/2" SH ... \$34.98



Router not included

M.POWER Combination Router Base, Model CRB7 MK3

The CRB7 MK3 Combination Router Base from M.POWER is an excellent accessory for fixed base and plunge routers alike. Seven functions out of the box include: small and large circle compass; offset mortising; anti-tilt



support; reference dadoing; faux panel copier; offset baseplate; and reference template routing. CRB7 MK3 Router Base fits all routers with fence rod drillings and quickly attaches to your router base. The base improves stability during offset operation and increases accuracy with micrometer adjustment. The Trim Kit Accessory for the CRB7 MK3 Router Guide is one of the simplest and quickest solutions to achieving a beautiful, flat finish when flush trimming wooden plugs and plywood edging. It attaches in seconds to the CRB7 Router Base, making quick work of plug trimming tasks - including pocket hole plugs, as well as trimming plywood edging. Accurately trim material for the making of a one-off piece of furniture or consistently with every pass to trim several plywood shelves in a set of kitchen cabinets. The Edge Guide Accessory for the CRB7 MK3 Router Guide is more versatile than a traditional edge guide, making it possible to rout micrometer precision grooves and dadoes up to 7/16" from the board edge. The Edge Guide Accessory also has three different fitting locations to take advantage of CRB7 full range of adjustment.

161757 CRB7 MK3 router base \$109.99

161758 (A) trim kit accessory \$29.99

161759 (B) edge guide accessory \$19.99

D/S = Item drop ships direct from manufacturer.

Router Accessories



Woodpeckers® Coping Sled

The Woodpeckers Coping Sled first traps the board between the adjustable top plate, adjustable for material up to 5 1/2" wide, and the fence. Second, two clamps hold the piece down to prevent lifting and two handles lock the clamp beam in place. The guide allows the sled to track along the fence rather than the miter slot making it faster and easier to set up and eliminates the need to align your router fence perfectly parallel to the miter slot. Includes detailed instructions.

151148 **\$144.99**

T-9 Rust Protectant

Developed by Boeing Aviation for long term metal protection on aircraft. A solvent and paraffin wax formula, it penetrates into metal pores, displaces moisture, and dries to a thin film that will protect your woodworking equipment for months. Offers long term storage protection for up to one year. Since it contains no silicones or Teflon® and dries completely within a few minutes, it will not transfer to wood surfaces or interfere with subsequent finishing. 12 oz. non-fluorocarbon spray is ozone safe.



03Q56 **\$18.99**

Rust Free. New, improved, the best we've ever tested! Removes rust and corrosion from most metal surfaces. Spray on and wash off rust with soap and water. 8.45 oz. pump.

03Q57 **\$12.59**

Blade & Bit. Removes resin, gum, and pitch from saw blades, router bits, drill bits, planer knives, and tool tops. Fast, safe and easy to use; simply wet the surface with this biodegradable liquid, allow to penetrate for 3-5 minutes, then wipe off. 8.45 oz., pump spray.

128479 **\$11.99**

Total Tool Care Kit includes one each of the above.

128478 set of 3 Save! **\$36.99**

CMT 2050

Blade And Bit Cleaner

Easily removes resin, gum and pitch without harsh or hazardous chemicals. Just wet the surface, allow a few minutes to penetrate, and wipe up the buildup. 18 oz. spray bottle.

817541 **\$13.19**



ProGold Lubricant PG2000, 16 Ounce Pump Spray

Let's face it, wood dust and lubricants don't mix. You need to keep the meshing surfaces of gears and pinions lubricated, but when you do, wood dust sticks. PG2000 Penetrating Lubricant treats the metal surface with a polarized layer of oil molecules that reduces friction and wear. Retards future corrosion.

147403 **\$10.50**



JessEm®

Clear-Cut™ Precision Stock Guides

Clear-Cut™ Precision Stock Guides are the ultimate hold-down on the router table. Featherboards are limited in their ability to guide material accurately against a router table fence, while Clear-Cut™ Stock Guides operate on the same principle as a stock feeder in that the stock is guided at a slight angle as it is fed forward. Urethane rollers with one-way needle bearings are mounted at a 5° angle effectively steering your stock toward the fence. Stock is pulled tightly to the fence, and the gripping force of the rollers holds it securely in position. Stock guides have 2 3/4" total adjustment with a maximum stock thickness equal to the distance from your router table surface to 9/16" below the center of the horizontal T-slot on your router fence. Compatible with most router table fences with a horizontal 1/4" T-slot above the fence faces. Includes one infeed stock guide, one outfeed stock guide and detailed instructions.

158903 **\$99.99**

Bostik®

Woodworking Lubricants

Bostik is all about working smarter, and TopCote®, DriCote® and Bearing Lubricant are smart, featuring proprietary formulations that bond to the microstructure of metal to reduce friction, prevent corrosion and extend tool and edge life. TopCote is a table lubricant that makes it easier to move wood and sheet goods across a surface while offering excellent protection against corrosion. Use DriCote on edge tools to prevent resin buildup and, most importantly, prolong the cutting edge life up to 300%. Bearing Lubricant, a heat resistant lube, is designed to prevent bearing failure under extreme use and is perfect for router bit bearings or as a general lubricant. These products will not stain wood and do not interfere with finishes and glues. Product name/label styles may vary but contain equivalent product.



124627 GlideCote® **\$19.99**

124626 BladeCote® **\$19.99**

124625 Bearing Lubricant **\$14.50**

154299 set of 3, above **\$44.99**



Bench Mate Nonslip Pad

Large 24" x 48" non slip pad allows you to work without the limitations of clamps or vises. Ideal for all woodworking jobs using a router, belt sander, pad or random orbit sander or working with hand tools. Unique web like design allows dust and chips to drop through the pad. To clean, rinse with water and lay flat to dry.

123633 **\$14.99**

Brass Router Bushing Set

Set comes in a durable blow-molded case and contains 2 lock nuts and 8 guides with 5/16", 3/8", 7/16", 1/2", 5/8", 3/4", 5/8", 5/8" and 1" outside diameters. All guides protrude 0.240" to work with any template material of 1/4" thickness and larger. Fits all routers with Porter-Cable style sub-bases.



144625 10-pc. set with case **\$42.50**

144688 5/16" OD x 1/4" ID **\$8.50**

144689 3/8" OD x 9/32" ID **\$8.50**

144690 7/16" OD x 11/32" ID **\$8.50**

144691 1/2" OD x 13/32" ID **\$8.50**

144692 5/8" OD x 17/32" ID **\$8.50**

144693 3/4" OD x 21/32" ID **\$8.50**

144694 5/8" OD x 5/8" ID **\$8.50**

144695 1" OD x 7/8" ID **\$8.50**

144696 bushing lock nut **\$3.99**



WoodRiver®

Router Bit Bearing Kit

Never be without just the right bit in the middle of a project again! This kit allows you to vary the depth of your rabbeting bits, or convert regular bits into top-bearing bits, or lettering bits. Kit contains two 1/4" stop collars, two 1/2" stop collars, six short and six long bearing screws, two hex keys for the bearing screws, and one each of the following diameter bearings: 3/16" ID x 3/8", 1/2", 5/8", 3/4", 7/8", 1 1/8" and 1 3/8" OD; 1/4" ID x 1/2", 5/8" and 3/4" OD; 1/2" ID x 3/4", 1 1/8" and 1 1/4" OD. Includes bearing lube applicator and plastic storage case.

145725 **\$59.99**

Woodpeckers®

Aluminum Router Table

8-Piece Insert Ring Set

includes a full complement of sizes to accommodate virtually any router bit. Includes: Solid, 5/8", 7/8", 1 3/8", 1 5/8", 1 7/8", 2 1/8" and 2 3/8" openings.

150673 **\$39.99**



3-Piece Blank Router Plate Insert Rings

Blank insert rings can be drilled or routed for a custom size. Each ring is molded of ABS reinforced with polycarbonate. Includes three (3) blank rings.

150995 **\$19.99**

Freehand Bit Guard

provides a pivot point to rest your material while you advance the workpiece into the spinning router bit. An integral shield keeps dust from flying up into your face while the laminated birch plywood and phenolic frame channels chips to the 2 1/2" dust port. Attaches directly to any Woodpeckers router plate or router lift.

148871 **\$36.99**



Router Table Insert Installation Template

Using this template and a template router bit you can rout out a perfectly sized 9 1/4" x 11 3/4" opening for any of the Woodpeckers router plates and lifts in your custom router table. CNC machined from 3/4" MDF for a perfectly smooth bearing surface and large enough for clamps.

150996 **\$14.99**



Wood River®

Core Box Bits

Core box bits produce a rounded bottom groove for fluting, panel edging and sign making. Two flutes, carbide.

- 144121 1/4" D x 1/4" CL, 1/8" R, 1/4" SH.....\$15.99
- 144120 3/8" D x 3/8" CL, 3/16" R, 1/4" SH.....\$15.99
- 144119 1/2" D x 3/8" CL, 1/4" R, 1/4" SH.....\$15.99
- 144118 3/4" D x 5/8" CL, 3/8" R, 1/4" SH.....\$20.99
- 147240 3/4" D x 3/8" CL, 3/8" R, 1/2" SH.....\$23.99
- 144117 1" D x 3/4" CL, 1/2" R, 1/2" SH.....\$29.99
- 147241 1 1/2" D x 7/8" CL, 3/4" R, 1/2" SH.....\$38.99



Straight Bits

Useful in dadoing, general grooving, sign making, and through cutting. 1/4" Shank, two flutes, carbide.

- 144146 3/16" D x 1/2" CL.....\$13.99
- 151178 1/4" D x 1" CL.....\$13.50
- 151179 5/16" D x 1" CL.....\$15.99
- 151180 3/8" D x 1" CL.....\$12.99
- 144148 1/2" D x 3/4" CL.....\$12.99
- 151181 1/2" D x 1" CL.....\$13.99
- 144149 5/8" D x 1" CL.....\$14.99
- 151182 3/4" D x 3/4" CL.....\$18.50

1/2" Shank, two flutes, carbide

- 151183 1/4" D x 3/4" CL.....\$13.99
- 144151 1/4" D x 1" CL.....\$14.99
- 151184 5/16" D x 1" CL.....\$12.99
- 151185 3/8" D x 1" CL.....\$14.99
- 144153 1/2" D x 1" CL.....\$15.99
- 151186 1/2" D x 1 1/4" CL.....\$13.99
- 144154 1/2" D x 1 1/2" CL.....\$15.99
- 144155 1/2" D x 2" CL.....\$17.99
- 151187 5/8" D x 1" CL.....\$18.50
- 144156 3/4" D x 1" CL.....\$15.99
- 151188 3/4" D x 1 1/4" CL.....\$17.99
- 144157 3/4" D x 1 1/2" CL.....\$23.99



Flush-Trim Bits

Features two flutes.

- 129684 1/2" D x 1" CL, 1/4" SH \$15.99
- 129685 1/2" D x 2" CL, 1/2" SH \$23.99

Antikickback Router Bits

The antikickback design of these industrial quality carbide router bits limits stock feed rate for safer router operation. Solid steel bodies are precision machined to carefully controlled tolerances. A final CNC machine 400-grit wet grind on the K-20 German carbide produces a clean, extremely sharp, and durable cutting edge. Bit bodies are coated to help prevent resin build up and make resin removal easier. All bits are carbide tipped.

D = diameter CL = cutting length
R = radius SH = shank diameter

WoodRiver® Dovetail Bits, 8mm Shank. These bits have 60% more metal than 1/4" shanks, giving you greater stiffness for enhanced usability and increased feed rates in hardwoods. Requires 8mm reducer for 1/2" collet routers.

- 143264 1/4" x 8°, 8mm SH.....\$18.99
- 143274 5/16" x 8°, 8mm SH.....\$18.99

- 143258 3/8" x 8°, 8mm SH.....\$20.99
- 143263 7/16" x 8°, 8mm SH.....\$18.99
- 143259 1/2" x 8°, 8mm SH.....\$18.99
- 143260 1/2" x 10°, 8mm SH.....\$20.99
- 143261 1/2" x 14°, 8mm SH.....\$20.99
- 143262 1/2" x 18°, 8mm SH.....\$20.99
- 143275 5/16" straight, 8mm SH.....\$18.99
- 143265 collet reducer 1/2" to 8mm...\$9.99



143262



Three-Wing Slotting Cutter Set

This seven-piece set slots, grooves and rabbets. Vary the width of your slot from 1/16" to 11/16" by stacking cutters and shims. Depth of cut with bearing is 1/2". Set includes 1/2" arbor, 10 shims, 1/16", 3/32", 1/8", 5/32", 3/16", 1/4" cutters and wooden box for storage and protection of the pieces.

- 147473\$81.50

Pattern Cutting Bits

For following templates and making plunge cuts. Cutter and bearing are same diameter.

- 1/4" Shank, two flutes, carbide.
- 129640 1/2" D x 1" CL.....\$21.99
- 129642 5/8" D x 1" CL.....\$23.99
- 1/2" Shank, two flutes, carbide.
- 147239 3/4" D x 1 1/4" CL.....\$29.99
- 129641 1 1/8" D x 1 1/2" CL.....\$34.99



Table Edge Bits

Create the classic edge dressing for solid wood tabletops.

- 129678 2 1/2" D, 1/2" SH.....\$57.99
- 129679 1 3/16" D, 1/4" SH.....\$35.99

Rabbeting Bit Sets

Cut five different widths with one bit. Change bearings for 1/4", 5/16", 3/8", 7/16", 1/2", up to 1/2" deep.

- 129687 rabbet set, 1/4" SH \$51.99
- 129688 rabbet set, 1/2" SH \$51.99



Panel-Raising Bits

2" D or 2 1/2" D, 1/2" SH, ball bearing guides.

- 129670 (A) ogee 2 1/2" D.....\$57.99
- 129671 ogee 2" D.....\$42.99
- 129672 (B) cove 2 1/2" D.....\$57.99
- 129673 cove 2" D.....\$41.99

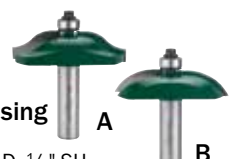

Tongue & Groove Bit

Cuts material up to 3/4" thick.

- 140801 1/4" SH.....\$51.99
- 140802 1/2" SH.....\$59.99



Round-Over Bits

For uniformly rounded edges. Changing the guide bearing to the 3/8" bearing listed below converts round-over bits to Beading Bits for decorative period edging on furniture.

- 147243 1/16" R, 1/4" SH.....\$18.99
- 129657 1/8" R, 1/4" SH.....\$20.99
- 147244 5/32" R, 1/4" SH.....\$19.99
- 147245 3/16" R, 1/4" SH.....\$19.99
- 129659 1/4" R, 1/4" SH.....\$19.99
- 147246 5/16" R, 1/4" SH.....\$20.99
- 129658 3/8" R, 1/4" SH.....\$20.99
- 129660 1/2" R, 1/4" SH.....\$29.99
- 147247 1/8" R, 1/2" SH.....\$20.99
- 129661 1/4" R, 1/2" SH.....\$22.99
- 147248 3/8" R, 1/2" SH.....\$23.99
- 129662 1/2" R, 1/2" SH.....\$29.99
- 129758 3/8" O.D. bearing.....\$4.99



Bead And Flute Bits

Used to make matching flute and bead edges on 1/4" thick wood strips so they can conform to a curved surface. 1/4" shank.

- 129683 (A) 1/4" bead cutter \$25.99
- 129682 (B) 1/4" flute cutter \$25.99
- 129686 bead & flute set.....\$44.98

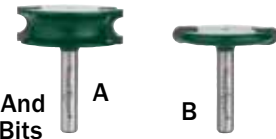

Biscuit Joining Router Bit Set

Each set features a 5/32" cutter, hex key and three bearings to cut slots for #0, #10 and #20 biscuits.

- 147994 1/4" shank.....\$36.99
- 147995 1/2" shank.....\$41.99



MILESCRAFT Plate Joinery Biscuits

Fits slots cut by all standard plate joiners and biscuit joiner router bits.

- 153575 #0 biscuits, (28 pcs.)\$2.99
- 153576 #10 biscuits(28)....\$2.99
- 153577 #20 biscuits (28) ...\$2.99
- 153579 #0 biscuits (125)....\$7.99
- 153580 #10 biscuits (100)...\$7.99
- 153581 #20 biscuits (85)\$7.99

WoodRiver® Router Collet Offset Wrench

The 3/4" fits most Hitachi and 3/4 HP Triton; 7/8" fits most DeWalt and Fein; 15/16" fits most Bosch, Makita and 2 1/4 HP Triton; 1 1/8" fits most Porter-Cable routers.

- 152670 3/4" wrench.....\$15.99
- 152671 7/8" wrench.....\$15.99
- 152672 15/16" wrench.....\$15.99
- 152673 1 1/8" wrench.....\$15.99



Value for price – The WoodRiver® Brand was created with quality and affordability so you can be sure that you are getting a smart value for your woodworking dollar. Quality + Price = VALUE, and that's what you get with WoodRiver!

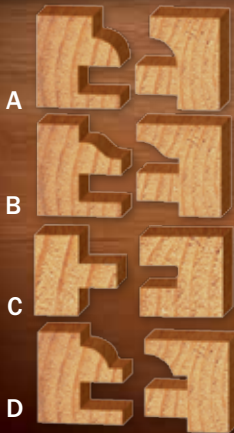

WHITESIDE 1/2" Shank Two-Piece Stile & Rail Door Sets

- Make full-sized stile and rail frames on your router table
- Allows you to cut the interlocking profile and the panel groove in one pass

150803 (A) round-over stile & rail set.....	\$114.99
150804 (B) ogee stile & rail set.....	\$114.99
148047 (C) shaker stile and rail set.....	\$104.99
150805 (D) bead stile and rail set.....	\$114.99
818469 7/32" plywood conversion kit.....	D/S \$38.99

Upcut Spiral Cutters

- For a smooth cut in all plunge routing
- Spiral design pulls waste from the cut and leaves a flat bottomed mortise
- Permits accurate cuts without chatter in any wood
- Solid carbide or HSS for exceptional results for serious woodworkers



WHITESIDE Solid Carbide Bits

	Cutting Dia.	Cutting Length	Shank Length	Overall Length	
03K32	1/8"	1/2"	1/4"	2"	\$20.99
814915	3/16"	3/4"	1/4"	2 1/2"	\$20.99
03K33	1/4"	1"	1/4"	2 1/2"	\$20.99
08K61	3/8"	1 1/4"	1/2"	3"	\$55.99
03K35	1/2"	1 1/2"	1/2"	3"	\$56.99

Onsrud HSS Bits

12W52	1/8"	3/8"	1/4"	2 7/8"	\$15.99
128718	1/4"	1"	1/4"	3"	\$16.75
03K42	1/4"	3/4"	1/2"	3 1/4"	\$29.99
12W53	5/16"	3/4"	1/2"	3 1/4"	\$29.99
03K43	3/8"	1 1/4"	1/2"	3 3/4"	\$29.50
03K52	1/2"	1 1/2"	1/2"	3 1/2"	\$37.99
03K53	3/4"	1 1/4"	1/2"	3 1/4"	\$69.99

WHITESIDE

Downcut Spiral Router Bits

Creates a clean edge around the hole or groove cut. Ideal for dados, shallow grooves or other cuts where the edge will be visible after final assembly. Solid carbide.

Whiteside RD1600 1/8" bit
1/8" D X 1/2" CL, 1/4" SH, 2" OL
09117 (shown)..... \$20.99

Whiteside RD2100 1/4" bit
1/4" D X 1" CL, 1/4" SH, 2 1/2" OL
812126 \$20.99

Whiteside RD2075 standard bit
1/4" D X 3/4" CL, 1/4" SH, 2 1/2" OL
814292 \$19.99



WHITESIDE Spiral Flush-Trim Bits

- For any flush trim application
 - Excellent choice for pattern or template work
 - Great for use with plywood, melamine or other laminated surfaces where chip-out is a concern
 - Downcut for handheld router operations or upcut for router table applications
 - Compression bit gives cleanest cut on both the top and bottom edge of the workpiece
- | | | |
|--------|---------------------------------------|---------|
| 127465 | 1/4" D, 1" CL, 1/4" SH upcut..... | \$42.99 |
| 127466 | 1/4" D, 1" CL, 1/4" SH downcut..... | \$42.99 |
| 127467 | 1/2" D, 1 1/4" CL, 1/2" SH upcut..... | \$84.99 |
| 127468 | 1/2" D, 1 1/4" CL, 1/2" SH downcut | \$87.50 |

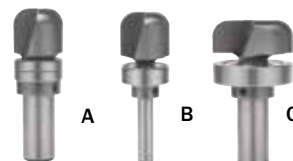

WHITESIDE Bowl & Tray Router Bits

- "Bowl" out a cavity of any shape with the aid of a template
 - Leaves a smooth, easy clean bottom corner
- | | | |
|--------|---------------------------------------|---------|
| 150511 | (A) 1/4" R x 3/4" D x 1/2" SH | \$35.49 |
| 24D85 | (B) 1/4" R x 3/4" D x 1/4" SH | \$31.49 |
| 825834 | (C) 1/4" R x 1 1/4" D x 1/2" SH | \$38.49 |

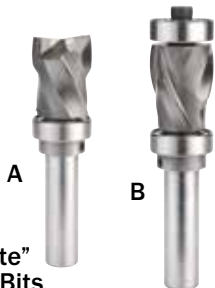

WHITESIDE "Ultimate" Flush Trim/Pattern Bits

- Perfect to trim matching wood surfaces with a router
 - Produces a superior quality trimmed edge
 - Compression spiral design, along with ball bearing guide
 - 7/8" D, 1 1/8" CL, 1/2" SH
- | | |
|---------------------------------|----------|
| 154276 (A) Pattern/Plunge | \$149.99 |
| 154274 (B) Combination | \$149.99 |



Solid Brass Router Inlay Kit

- For absolutely perfect fitting inlay repairs and decorations
- The precision-machined bushing with collar and cutter can be installed in your router to follow the template and cut the design in your work
- Remove the collar from the bushing and cut the positive inlay using the same template for a perfect fitting inlay
- Solid carbide downcut spiral bit, quick-change bushing, template guide, instructions
- Fits Porter Cable, Black and Decker, and any router with a Porter Cable style bushing adapter

09116 1/8" Complete Set..... \$48.99

09117 repl. 1/8" downcut spiral bit..... \$20.99

159213 1/4" Complete Set..... \$68.99

814292 repl. 1/4" downcut spiral bit..... \$19.99



WHITESIDE 3-Wing Slotting Cutters

- Superior to straight router bits for slotting edges
- Carbide tips cut spline joints in solid wood, plywood, and particleboard
- Cuts slots up to 1/2" deep quickly and cleanly
- Requires arbor listed below to operate

24D61 1/16" cutter only..... \$16.49

24D62 5/64" cutter only..... \$18.49

24D63 3/32" cutter only..... \$17.99

24D64 1/8" cutter only..... \$20.49

24D65 5/32" cutter only*..... \$20.49

24D66 3/16" cutter only..... \$20.49

24D67 1/4" cutter only..... \$20.49

24D68 1/4" shank arbor w/bearing..... \$10.79

24D69 1/2" shank arbor w/bearing..... \$9.99

*Proper Size for cutting plate joiner biscuit slots.



WHITESIDE Traditional Flush Trim Bits

- Most commonly used
- Bearing and diameter same size

	Dia.	Cutting Length	Shank	
24A72	1/2"	1"	1/2"	\$18.99
24A73	1/2"	1 1/2"	1/2"	\$22.99



Carbide Tipped Router Bits

- Top quality router bits for more than 30 years
- The latest technology, state-of-the-art machinery and expert craftsmen
- Accurately ground thick, high-grade carbide for the smoothest finishes
- Each bit is inspected after each manufacturing step
- Made in U.S.A.

All bits are carbide tipped unless noted. D=Diam.; CL=Cutting Length; R=Radius; SH=Shank Diameter; SC=Solid Carbide



Straight Bits 1/4" shank, two flutes.

24A01	SC 1/8" D x 3/8" CL	\$15.49
24A04	1/4" D x 3/4" CL	\$14.99
24A07	5/16" D x 1" CL	\$16.99
24A08	3/8" D x 1" CL	\$18.99
24A10	1/2" D x 1" CL	\$19.49
24A15	5/8" D x 3/4" CL	\$19.49
24A14	3/4" D x 3/4" CL	\$19.99

Straight Bits 1/2" shank, two flutes.

24A31	1/4" D x 3/4" CL	\$18.99
24A33	3/8" D x 1" CL	\$18.49
24A35	1/2" D x 1" CL	\$17.49
24A36	1/2" D x 1 1/2" CL	\$19.49
24A38	5/8" D x 1" CL	\$18.99
24A39	3/4" D x 1" CL	\$20.99
24A43	1" D x 1 1/4" CL	\$27.99

Cove Bits For decorative edging with an inverted radius. Two flutes with bearing.

24C92	1/4" R, 1/4" SH	\$29.99
24C93	3/8" R, 1/4" SH	\$32.99
24C94	1/2" R, 1/4" SH	D/S \$27.99
24D11	1/4" R, 1/2" SH	\$29.99
24D12	3/8" R, 1/2" SH	\$30.49
24D13	1/2" R, 1/2" SH	\$34.49

V-Groove Bits Cut shallow and deep grooves for signs or furniture decorations. Two flutes. With 90° or 60° V-cut angle.

24B70	90° 3/8" D x 3/8" CL, 1/4" SH	\$19.49
D/S 842400	90° 1" D x 5/8" CL x 1/2" SH	\$39.99
24B81	60° 1/2" D x 5/8" CL x 1/4" SH	\$23.99

Dovetail Bits Use with dovetail templates.

818071	1/2" x 10°, 1/2" SH	\$24.99
24D41	1/2" x 14°, 1/4" SH	\$20.99
24D42	1/2" x 14°, 1/2" SH	\$28.99
24D43	3/4" x 14°, 1/2" SH	\$24.49
24D44	1/4" x 7.5°, 1/4" SH (SC)	\$23.49
24D45	3/8" x 14°, 1/4" SH...D/S	\$17.99
148965†	17/32" x 7°, 1/4" SH	\$23.49
146433†	17/32" x 7°, 1/2" SH	\$23.49

†Used on PC 4210 & 4212 jigs

Round-Over Bits For smooth, uniformly rounded edges. Lowering the depth setting will produce a rounded corner with a decorative fillet. Two flutes with bearing.

24B91	1/16" R, 1/4" SH	\$24.99
24B92	1/8" R, 1/4" SH	\$24.49
24B93	3/16" R, 1/4" SH	\$25.49
24B94	1/4" R, 1/4" SH	\$25.49
24B95	5/16" R, 1/4" SH	\$27.99
24B96	3/8" R, 1/4" SH	\$27.99
24B97	1/2" R, 1/4" SH	\$34.49
146203	1/8" R, 1/2" SH	\$23.99
24C22	1/4" R, 1/2" SH	\$25.49
24C24	3/8" R, 1/2" SH	\$27.99
24C25	1/2" R, 1/2" SH	\$34.49
24C27	3/4" R, 1/2" SH	\$60.99

Chamfering Bits

Cut bevels with bearing guide.

149227*	7/16" CL, 1/4" SH, 45°	\$27.99
24L08	5/8" CL, 1/4" SH, 45°	\$28.49
24L18	5/8" CL, 1/2" SH, 45°	\$28.49
24D32	1 1/16" CL, 1/2" SH, 45°	\$47.99
158805	1" CL, 1/2" SH, 60°	\$77.99

*Fits laminate trim routers

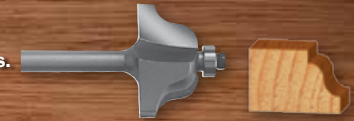

Roman Ogee Bits For classic decorative edges.

24E17	1/4" R x 11/16" CL, 1/4" SH	\$40.49
24E18	5/32" R x 9/16" CL, 1/2" SH	\$37.49
24E19	1/4" R x 11/16" CL, 1/2" SH	\$40.49



Raised Panel Bits 1/2" shank, ball bearing pilot.

24F26	ogee, 2 1/2" D x 2 wing	\$80.99
24F36	bevel, 2 1/2" D, 25° x 2 wing	\$80.99
24F37	bevel, 3 3/8" D, 16° x 3 wing	\$109.99
24F46	cove, 2 1/2" D x 2 wing	\$80.99
24F47	cove, 3 3/8" D x 3 wing	\$109.99

Replacement Bearing (Standard Size)

24Z91	1/2" D x 3/16" hole	\$5.50
-------	---------------------	--------

Router Bit Shank Reducers

- Universal split-type steel bushing allows 1/4", 3/8" or 8mm shank bits to fit routers with 1/2" collets. 1 1/4" overall length.



128665	1/4" shank to 1/2" collet	\$13.49
111164	3/8" shank to 1/2" collet	\$13.49
125110	8mm shank to 1/2" collet	\$13.49

WHITESIDE Pattern Cutting Bits

- Allows you to put your pattern on top of the wood and see your cut
- Special bearing and stop collar assembly lets you move smoothly around the pattern
- Use in a router table with the pattern on the bottom
- Bearing and cut diameter are same size for flush trimming

	Dia.	Cutting Length	Shank	
24A61	1/2"	1"	1/4"	\$25.99
24A62	5/8"	1"	1/4"	\$31.49
24A63	1 1/8"	1 1/2"	1/2"	\$48.99

WHITESIDE Pointed Round-Over Bits

- Extremely versatile
- Ideal for fluting, beading, molding and even sign carving

	Radius	Diameter	Shank	
127281	3/16"	3/8"	1/4"	\$22.49
127282	1/4"	1/2"	1/4"	\$23.99
127283	3/8"	3/4"	1/4"	\$30.49
127284	3/8"	3/4"	1/2"	\$30.49



WHITESIDE Plywood Dado Bits

- Eliminates the frustration caused by using dadoses with undersized hardwood plywood
- Odd-sized, straight bits for a precision dado with a tight, no-slop fit
- Ideal for 1/4", 1/2" and 3/4" plywood sizes

	Diameter	Cut Lgth.	Shank	
812917	7/32"	3/4"	1/4"	\$18.99
845066	7/32"	3/4"	1/2"	\$26.99
24K07	31/64"	3/4"	1/4"	\$19.49
24K17	31/64"	1"	1/2"	\$19.50
24K09	23/32"	3/4"	1/4"	\$23.79
24K19	23/32"	1"	1/2"	\$21.49
3-piece Dado Bit Set (with storage case)				
150756	1/2" Shank			\$55.99



WHITESIDE Rabbeting Sets

- For drawer fronts, tenons, box lids, and rabbets
- Includes all bearings to make rabbets 1/8", 3/16", 1/4", 5/16", 3/8", 1/2", and 5/8" deep
- Full diameter bearing for smooth flush trimming
- 1/2" cutting length
- Safe and smooth cuts with added face-shear
- 8 bearings, Allen wrench, rabbeting bit, bearing storage "trees", fitted box with cover

143222	1/4" SH	\$62.49
143223	1/2" SH	\$62.49

D/S = Item drop ships direct from manufacturer.

Router Bits

freud

Precisely the best.

Freud Router Bits are the most innovative, precise and best performing bits on the market.

All bits are carbide tipped unless noted. D=Diam.; CL=Cutting Length; R=Radius; SH=Shank Diameter; SC=Solid Carbide; A=Degree Angle

Freud's Premier Adjustable Rail & Stile System

With Freud's unique, patented system, you are able to build any style of cabinet door in a range of door thicknesses and sizes! Create extended tenons for extra door joint strength, adjust groove width for different panel thicknesses and choose from a variety of material thicknesses 5/8" to 1 1/4".

2-Piece Rail & Stile sets

1/2" Shank	
150675	Round-over..... \$127.47
150676	Ogee profile..... \$127.47
150677	Bead profile..... \$127.47
850347	Shaker profile..... \$127.47



Add additional cutters to the bits above to create thicker doors with double profiles and glass panel doors. *Rail & Stile sets sold separately

3-Piece Adjustable Cabinet Door Sets combine the new adjustable rail and stile bits with your choice of panel profile in medium (2 3/4" dia.) or large (3 1/2" dia.) Quadra-Cut™ raised-panel cutter. The 150687, 150688, 150692 and 845683 include a raised panel w/ back cutter.

1/2" Shank 3-Piece Sets

150684	lg. bevel panel, round rail..... \$183.47
150685	lg. cove panel, round rail..... \$183.47
150686	lg. ogee panel, round rail..... \$183.47
150687	lg. bevel panel w/bc, rnd. rail... \$195.97
150688	lg. cove panel w/bc, round rail \$195.97
150689	lg. bevel panel, ogee rail..... \$183.47
150690	lg. cove panel, ogee rail..... \$183.47
150691	lg. ogee panel, ogee rail..... \$183.47
150692	lg. cove panel w/bc, ogee rail..... \$201.97
845683	lg. ogee panel w/bc, ogee rail..... \$201.97
150693	med. ogee panel, ogee rail..... \$183.47



Adjustable Tongue & Groove Set

For stock thickness of 1/2" to 1 1/4". Groove cutter adjusts for widths of 7/32" to 3/8".

1/2" Shank	(FREUD part #)
825745 (99-036) \$79.97



Premier Solid Carbide Bits

Exclusive TiCo™ Hi-Density Solid Carbide bits outperform the market in both finish quality and bit life.

1/4" Shank (Up Spiral)	
828750	1/8" D, 1/2" CL, SC (75-100) \$21.97
828778	1/4" D, 1" CL, SC (75-102) \$24.47

1/2" Shank (Up Spiral)	
828779	3/8" D, 1 1/4" CL, SC (75-106) \$51.47
828780	1/2" D, 1 1/4" CL, SC (75-108) \$67.47

1/4" Shank (Down Spiral)	
828781	1/4" D, 1" CL, SC (76-102) \$22.97

1/2" Shank (Down Spiral)	
840349	3/8" D, 1 1/4" CL, SC (76-106) \$50.97
838516	1/2" D, 1 1/4" CL, SC (76-108) \$57.97

Five Piece Up Spiral Bit Set: Quickly create grooves, mortises, and dados with chip removal.
840727 solid carbide..... (90-150) \$159.97



Rabbeting Bits

This router bit can also be used as flush cutting trim bit. Includes hex wrench and bearings for 1/8", 1/4", 5/16", 3/8", 7/16" and 1/2" wide rabbets.
828704 1/2" CL, 1/4" SH..... \$57.47
828705 1/2" CL, 1/2" SH..... \$57.47
829436 3/4" CL, 1/2" SH..... \$62.47



Base Cap & Molding Bits

Create baseboard or traditional "mop" boards in any width from any wood.

837211	(A) style 163..... \$67.47
837228	(B) baseboard bit \$51.47



Quadra-Cut™ Raised Panel Bits

Ideal for creating raised panels, decorative tops, & molding. Patented design produces a full 1 1/2" wide reveal. Bits with back-cutter (b/c) include shims to allow adjustment of tongue thickness from 7/32" to 1/4".

1/2" Shank Bevel Profile	
828933	3 1/2" D..... (99-515) \$98.97
828802	3 1/2" D, w/bc (99-566) \$119.97

1/2" Shank Cove Profile	
833266	3 1/2" D..... (99-518) \$104.47
828803	3 1/2" D, w/bc (99-569) \$119.97

1/2" Shank Ogee Profile	
828801	3 1/2" D..... (99-520) \$104.47
839402	3 1/2" D, w/bc (99-571) \$119.97

Round-Over Bits

Ideal for softening furniture edges & creating decorative beads.

1/4" Shank	
828706	1/8" R (34-104) \$29.97
828707	3/16" R..... (34-108) \$31.47
828852	1/16" R..... (34-100) \$28.47

1/2" Shank	
828708	1/4" R..... (34-110) \$35.47
828709	5/16" R..... (34-112) \$35.47
828710	3/8" R..... (34-114) \$35.97
828711	1/2" R..... (34-116) \$42.47

1/2" Shank	
815157	1/4" R..... (34-120) \$35.97
828712	3/8" R..... (34-124) \$39.97
828713	1/2" R..... (34-126) \$51.97
828714	5/8" R..... (34-127) \$55.97
828715	3/4" R..... (34-128) \$71.47
815153	1" R..... (34-132) \$118.97

Beading Bits

Add an attractive bead profile to furniture & millwork.

1/4" Shank	
828717	1/4" R..... (36-110) \$32.47
828719	3/8" R..... (36-114) \$35.97

1/2" Shank	
840958	5/16" R..... (36-122) \$38.97
828859	3/8" R..... (36-124) \$39.97
828860	1/2" R..... (36-126) \$51.97

D/S = Item drop ships direct from manufacturer.

Undersized Dado Router Bit Sets for Plywood



Freud's Undersized Plywood Bit Sets feature down-shear design for perfect fitting joints with no splintering! Available in 1/4" or 1/2" shank sets. Each 3-piece set includes 7/32", 15/32", and 23/32" diameters. 4-Piece set includes 7/32", 23/32", 11/32" and 15/32" diameters.

3-Piece Set	
850911	1/4" SH (89-660) \$51.47
850912	1/2" SH..... (89-670) \$58.47
4-Piece Set	
814819	1/4" SH (90-106) \$61.97

Roundnose Bits

Ideal for fluted millwork, signs & decorative veining.

1/4" Shank	
828681	1/8" R, 1/4" D..... \$19.97
828683	1/4" R, 1/2" D..... \$25.97
828685	3/8" R, 3/4" D..... \$29.47
1/2" Shank	
828686	1/4" R, 1/2" D..... \$34.97
828687	3/8" R, 3/4" D..... \$42.47

Straight Bits

These Double Flute Bits are ideal for general stock removal with a smooth finish.



Double-Grind™

1/4" Shank	
828656	1/8" D, 3/8" CL..... \$14.97
828657	3/16" D, 1/2" CL..... \$15.97
828659	1/4" D, 1" CL..... \$16.47
828661	5/16" D, 1" CL..... \$16.47
828662	3/8" D, 1" CL..... \$16.97
828665	1/2" D, 1" CL..... \$17.97
828666	5/8" D, 3/4" CL..... \$18.47
828667	3/4" D, 3/4" CL..... \$20.47
828805	1/16" D, 1/4" CL..... \$14.97

Double-Grind™

1/2" Shank	
828668	1/4" D, 3/4" CL..... \$19.97
828669	3/8" D, 1 1/4" CL..... \$18.97
828670	1/2" D, 1 1/4" CL..... \$18.47
828671	1/2" D, 1 1/2" CL..... \$21.97
828672	1/2" D, 2 1/2" CL..... \$30.97
828673	23/32" D, 1 1/4" CL..... \$27.47
828674	3/4" D, 1 1/2" CL..... \$24.97
828675	1" D, 1 1/4" CL..... \$27.97
834230	1/2" D, 1" CL..... \$18.47
834233	5/8" D, 1" CL..... \$22.97
835495	1/4" D, 7/8" CL..... \$19.97
835497	3/4" D, 1 1/4" CL..... \$22.97

Chamfer Bits

Create a uniform chamfer on the edge of any workpiece.

1/4" Shank	
828724	15° A, 1/2" CL..... \$29.47
828726	45° A, 1/2" CL..... \$32.47
828727	45° A, 5/8" CL..... \$35.97
834269	30° A, 3/4" CL..... \$45.97

1/2" Shank	
828728	45° A, 5/8" CL..... \$36.97
828882	22 1/2° A, 7/8" CL..... \$35.47
828883	45° A, 1" CL..... \$63.47

Bearing Flush Trim Bits

Ideal for smooth, burn-free cuts in trimming laminate counter tops and doing pattern work.

1/4" Shank	
828729	3/8" D, 1" CL..... \$16.97
828730	3/8" D, 1/2" CL..... \$17.47
828731	1/2" D, 1" CL..... \$16.97
828732	1/2" D, 1/2" CL..... \$17.47

1/2" Shank	
828733	1/2" D, 1" CL..... \$18.97
828734	1/2" D, 1 1/2" CL..... \$20.97
828735	1/2" D, 2" CL..... \$29.47



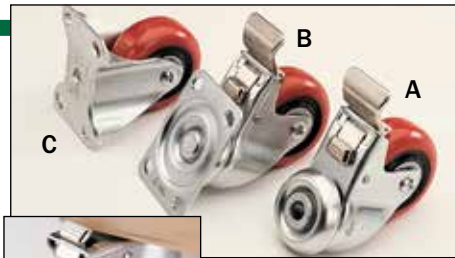

Heavy-Duty Casters

Put your entire shop on wheels! These casters feature easy rolling, non-marring, polyurethane tires that will not "flat spot" from remaining stationary. The swivel and the wheel ride on ball bearings. The double brake on styles (A) and (B) locks the wheel and swivel rotation with the touch of a toe. Style (C) is non-locking, non-swiveling with a 4 hole mounting plate. Style (D) is available with 3" or 2 1/2" dia. wheels and a choice of 1/2" or 3/8" diameter,

1 1/2" long threaded stems for the 3" version or 1" long, 3/8" diameter stem for the 2 1/2" version. Style (E) is a non-locking, swivel rotation with a 4-hole mounting plate. The 3" to 5" casters have a load rating for each caster of 300 lbs. The 2 1/2" casters have a load rating of 132 lbs. for each caster. Styles may be mixed or matched for quantity pricing.

For more info, visit woodcraft.com.

	Style	Wheel	Each	5+
152838	B	2 1/2"	\$13.99	\$12.59
152837	C	2 1/2"	\$11.99	\$10.79
152839	D	2 1/2", 3/8" D. stem	\$14.99	\$13.49
152836	E	2 1/2"	\$12.99	\$11.69
140639	A	3"	\$19.99	\$17.99
141051	B	3"	\$18.99	\$17.09
141052	C	3"	\$11.99	\$10.79
141050	B	4"	\$20.50	\$18.45
141053	C	4"	\$13.99	\$12.59
140642	B	5"	\$21.99	\$19.79
141054	C	5"	\$14.99	\$13.49
148594	D	3", 3/8" dia. stem	\$19.50	\$17.55
148595	D	3", 1/2" dia. stem	\$19.50	\$17.55

WoodRiver® Machine Casters

Heavy-duty, plate mounted machine casters with a weight rating of 300 kg (660 lbs.) each or 600 kg (1,320 lbs.) per 4 casters. More than just wheels for your machine, they also feature a foot which when lowered not only raises the machine off the caster but may also be used to level your machine. The feet also help reduce vibration while the machine is in use. Each set of four casters comes with a wrench for lowering and adjusting the foot under load.



149511 set of four \$109.99



Kaizen Foam™

Kaizen Foam™ is another great product designed to help you achieve maximum organization and visual control in your workspace! Kaizen Foam peels away in layers, creating a perfect fit for all your tools in drawers and on walls. The inexpensive, high performance, super tough foam is easy to peel

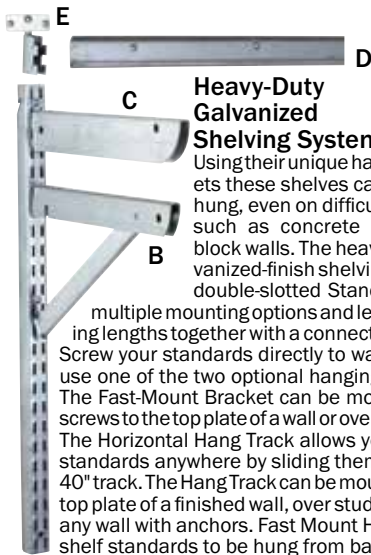

Heavy-Duty Galvanized Shelving System

Using their unique hanger brackets these shelves can be easily hung, even on difficult surfaces such as concrete or cement block walls. The heavy-duty, galvanized-finish shelving systems double-slotted Standards offer

multiple mounting options and lengths by tying lengths together with a connector bracket. Screw your standards directly to wall studs, or use one of the two optional hanging brackets. The Fast-Mount Bracket can be mounted with screws to the top plate of a wall or over wall studs. The Horizontal Hang Track allows you to place standards anywhere by sliding them along the 40" track. The Hang Track can be mounted to the top plate of a finished wall, over stud walls, or to any wall with anchors. Fast Mount Hooks allow shelf standards to be hung from basement sill plates. Two types of shelf brackets are available:

- A Double Brackets rated at 150 lbs. per bracket; Supported Brackets rated at 300 lbs. per bracket. Unless noted, all components are sold individually.
- 147670 6' shelf standard..... \$16.99
- 147671 4' shelf standard..... \$10.25
- 147672 (A) 2' shelf standard \$7.75
- 147673 20" supported shelf bracket \$11.50
- 147674 13" supported shelf bracket \$8.50
- 147675 (B) 10" supported shelf bracket.. \$6.50
- 147676 14" double shelf bracket..... \$7.19
- 147677 (C) 10" double shelf bracket..... \$5.50
- 147678 (D) horizontal hang track \$6.50
- 147679 (E) fast-mount bracket \$4.79
- 147681 mounting screws (14)..... \$3.19
- 147875 fast-mount hook \$5.25

Heavy-Duty Shelving Kit includes three 6' shelf standards, three 2' shelf standards, three 20" supported brackets, six 13" supported brackets, and six 10" supported brackets. Screws not included.

147682 Save!..... \$144.99



HTC Port-A-Mate Six-Tier Wood Rack

The Portamate Wood Rack is a multipurpose racking system that provides generous storage capacity for wood, pipes and other long items. For both external and internal applications, the unit suits workshops, garages and sheds. The powder-coated steel tube rack provides six levels of storage, holding 110 lbs. of material per level. Shelf brackets are 12 1/2" long, and wall standards are 39" long. The Portamate Wood Rack is easy to install.

152860 \$74.99



WoodRiver® HD Shelf System

Get your lumber and accessories up off the floor with the WoodRiver® HD Shelf System. Designed to help you customize your storage, the six included shelf brackets make three shelves, which can be moved in 6" increments up or down the upright supports to accommodate a wide range of materials. Or, twist the brackets in to keep them out of the way when not in use. Brackets alone can store lumber, pipe and other long materials. Add a flat board to store boxes, bins, cans of finish and more. Each bracket set can support up to 400 lbs. while the entire system can hold up to 1,200 lbs. when properly affixed to the wall. Each bracket is 12" x 1 1/8" square and slightly angled. Each upright is 1 5/8" diameter x 44" high. Additional shelf brackets are available.

158999 shelf system..... \$89.99

158998 (A) shelf brackets, 2-pack \$19.99



Lumber Rack Storage System

This high load capacity system features Straps in 24" and 55" lengths, formed from 3/16" thick steel and coated with a rust protective coating. The 24" Strap has a mounting tab that nests under the 55" Strap for applications where the units are stack mounted. Straps have "keyed" adjustment holes, spaced 1 1/2" apart, to lock the Brackets into the Straps. The Brackets are also 3/16"-thick coated steel, rolled to form an inverted "U" shape for strength. The 18" Bracket will support a 300-lb. load at the tip. The shorter Brackets will support even more weight. The Straps should be anchored to the wall with heavy lag type bolts or expansion studs in concrete. The Straps should also contact the floor or a spacer to transfer the weight of the rack from the wall to the floor. Straps should be placed no farther than 36" apart to properly support the weight of the lumber.

For more info, visit woodcraft.com!

142673 24" strap..... \$15.50

142674 55" strap..... \$29.99

142675 10" bracket..... \$10.25

142676 14" bracket..... \$12.75

142677 18" bracket..... \$18.99

Lumber Rack Set. All the straps and brackets you need to efficiently store a variety of 8-foot lengths of lumber. Includes: three 24" and three 55" straps; three 10" brackets, six 14" brackets and six 18" brackets. Set does not include mounting bolts.

131189 complete set Save! \$268.99

in 1/8" x 24" x 48" layered sections. Great for shop/home/office, vertical applications and toolboxes.

850573 20mm (7/8") black \$10.99

850575 30mm (1 1/8") black..... \$14.99

850577 57mm (2 1/4") black..... \$24.99

856352 (A) Kaizen knife..... \$2.99

158878 repl. blades, 10-pc. \$3.29

Shop Accessories



Lumber Wizard 4 Laser Line

The Lumber Wizard 4 Laser Line is the latest innovation in metal detection technology from Wizard Industries. This powerful, precision, handheld metal detector has been designed specifically for woodworkers and will detect metal objects that may be hidden in new or reclaimed lumber. A 6"-wide Laser Line scanning path allows one-handed operation and quick coverage of large surface areas. The combination of a Piezo tone beeper and LED red light indicator provides the necessary alerts for any hidden metal object in the wood being scanned. Operates up to 40 hours with one 9-volt battery (not included). One-year warranty.



153262 \$149.99

GENERAL TOOLS

Pin/Pinless Moisture Meter

An excellent option for the woodworker who uses a wide variety of species, the MMD900 is a dual type moisture meter with both pin and pinless capability for measurements in %WME (pin) and REL (pinless). Pinless measurements can be made up to 2" deep via a sensor on the back of the meter. Dual displays include a Jumbo LCD and 40-dot LED bar graph dual display. Comes with a hard carrying case, protective cover which doubles as a calibration checker, two sets of extra pins, remote pin-type probe, instructions and battery.

153774 \$169.99



GENERAL TOOLS

Moisture Meter MMD4E

General's ultrasensitive Pin-Style Digital Moisture Meter easily detects moisture from 5 to 50% in wood and 1½ to 33% in building materials by utilizing the wood/building materials selection switch. Features LED display (low, medium and high moisture sounds and on-screen icons), data hold, auto power off, low battery indicator, and replaceable stainless still pins. Meter includes protective cap, battery and user's manual.

844319 \$49.99



GRIP

14" Dual Power LED Shop Light

A new, more versatile shop light. GRIP started with the light source, upgrading it to a single LED bulb, and then made the light head adjustable from a wide to a very narrow beam light to make it suitable for a wide range of applications. The light is powered by 2 AAA batteries (not included), or it can be plugged into any standard outlet. A very strong magnet permits attachment to any steel or iron surface, or you can use the Accessory Clamping Bracket to fasten it to any surface up to 2½" in thickness. Perhaps the greatest feature is the 14" gooseneck that can be bent in any direction and stays securely where it is pointed. Comes with Transformer and Accessory Clamping Bracket.

160200 \$39.99



PINNACLE®

Leather Shop Apron

This heavy, full-grain leather shop apron provides great protection but is soft and pliable for your comfort. A full 21" x 27", the extra length helps protect your clothing from sawdust and stains, and keeps sawdust and shavings out of your pants pockets. There are two breast pockets, one sewn for pencils and the other large enough for your safety glasses, and two large lower pockets with full flaps to keep your stuff in and debris out. Fully adjustable shoulder straps crisscross and are sewn in the back to keep the weight on your shoulders instead of your neck. For durable, comfortable protection in your shop this apron is what you need.

149422 \$98.50



GENERAL TOOLS

Pin Style Precision Multi-Species Wood Moisture Meter MMD8P

The Precision Multi-Species Wood Moisture Meter (MMD8P) is designed for use in woodworking and lumber selection or purchasing. It's ideal for measuring the moisture content of 48 specific types of wood or lumber, with temperature compensation. The MMD8P is the first moisture meter on the market with an OLED (Organic Light-Emitting Diodes) display, which provides extraordinary contrast and extra clarity in outdoor lighting conditions. The meter displays a code number and the corresponding species name of the wood being measured. This is far more convenient than models that display a code number that users have look up in a manual to identify the species name. With the MMD8P users can compensate moisture measurements for the effect of ambient temperature (such as when taking lumber from outdoors to indoors or from kiln to outdoors), which greatly improves the accuracy of readings. The MMD8P also can measure and display ambient temperature and relative humidity (RH) alongside the moisture level measurement. What's more, it can store and recall up to 99 moisture measurement records, including the moisture level measurement, number and name of the wood species tested, ambient temperature and relative humidity at the time of measurement and any temperature compensation applied. Some comparable models offer data storage but do not allow as many parameters to be stored. Meter comes with 9V battery, custom hard carrying case and user's manual.

159503 \$199.99

PERFORMANCE TOOL

VS Electric Shop Blower

Compact, stable and much smaller than a fan, this shop blower is the perfect air mover for your garage and shop. It is constructed from durable ABS plastic with a built-in overload switch and two 15-amp, three-pronged grounded outlets. Variable-speed switch - 900 to 1500 RPM - moves up to 300 CFM max to help keep your garage or shop comfortable when the mercury is rising outside.

160671 \$79.99

161489 (A) 120V heater attachment..... \$39.99

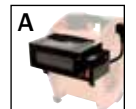

BucketBoss® Duckwear

SuperBib Apron

Protect your body and keep your tools handy with the BucketBoss® Duckwear SuperBib Apron. Made of 18 oz. Duckwear Canvas, the 23"-wide apron provides maximum protection from flying debris and comes with 16 pockets and 2 web loop hammer holders. The adjustable belt fits waists from 27" to 52" and has a quick-release buckle. Suspenders with padded shoulder straps ensure that the apron stays in place on your torso.

159349 \$24.99



15 oz. Insulated Stainless Steel Mug With Travel Lid

This mug keeps cold drinks cold and hot drinks hot ... maybe not forever but long enough to get comfortable and enjoy. The travel lid helps keep everything hot or cold longer. We won't claim the mug is unbreakable, but it will stand up to a lot more than normal abuse.

860909 \$7.50



LIGNOMAT Mini-Ligno E/D

The Mini-Ligno E/D is a pinned meter with digital readout capable of detecting from as little as 6% up to 55% moisture content depending on the wood group selected. Simply select the proper wood group and press the pins into the wood and the red LED will indicate wood moisture in percent for a temperature of 70° F. Use the included correction table for different temperatures. Comes with instructions, specie card and carry pouch. Requires 9v battery, not included.

150259 (A) \$119.99



LIGNOMAT Scanner S/D

The Scanner S/D is a dual depth (¼" or ¾") pinless, capacitance-type meter that uses the relationship between the dielectric properties and the moisture content of the wood to produce a moisture reading. Pinless meters leave no mark and are the preferred moisture testing tool for visible surfaces like cabinet doors, table tops or ready to finish furniture. The S/D does not require temperature correction, while measuring moisture content from 5% - 99%. Includes instructions, specie card and carry pouch. Requires 9v battery, not included.

150260 (B) \$289.00



LITTLE WIZARD Metal Detector

Alerts you to the presence of metal metal with LED lights and an audible tone. Requires one 9-volt battery, not included.

142012 \$25.50

LED Magnifying Lamps

LED Powered Magnifying Lamps feature a clear, 3 diopter (1.75x) glass lens for distortion free visibility. A spring-balanced arm, with spring and tension adjustment knobs, allows positioning of the lamp head in a variety of positions. The included table clamp allows for table or workbench top mounting, and a flip dust cover keeps the lens clean when not in use. 115V AC.

152996 (A) 60 LED 5" dia. lens..... \$74.99



Anti-Fatigue Floor Mats

Our mats are engineered for proper leg and back support in the workshop, at home, or anywhere you stand for extended periods of time. Made from a durable, tough PVC material that creates a nonslip surface that is easy to clean. Protect your floors at the same time you shield your falling tools from damage. These black mats are approximately 2' x 5' x 3/8" thick with a beveled edge.

146033 \$36.50



FastCap® Speed Skate

The Speed Skate allows you to move large and heavy materials around the job or shop by yourself. It easily supports 4' x 8' sheets of material up to 1 3/4" wide. Large wheels and ball bearings allow you to move boards without a struggle.

159392 \$24.99

Rugged Blue Denim Workshop Apron

Wrap around design keeps loose clothing from getting caught in machinery and protects clothes from being soiled by finishing materials. Two pockets provide ample room for pencils, rules, and tape measures. 37" long.

15L03 \$20.99



Woodshop Clock With Thermometer And Hygrometer

What a great addition to any shop! You'll not only know the time, but also the temperature and humidity with our Woodshop Clock and integrated thermometer/hygrometer. The 10" black face, chrome hands and markings are easy to read and good looking too! Temperature is displayed in 5-degree increments (Fahrenheit), while the hygrometer indicates relative humidity in 2% intervals. Quartz movement requires one AA battery (not included).

146137 \$29.99



WoodRiver® Workbench Caster Set

Wouldn't it be nice to have your workbench where you needed it? Now you can. Rugged steel construction gives these casters 110-lb. capacity (440 lbs. per set). The casters swivel 360°, giving you the ability to move to any position in the shop. Tough 2 3/8" urethane wheels won't mar the floor or flatten due to the weight. Each foot pedal allows you to lift the bench 3/4" off the floor. Includes mounting screws and instructions.

158547 \$79.99



Shop Stool With Adjustable Height

- Molded "Tractor-Style" Seat; 330 lb. Weight Capacity
- Chrome Foot Ring And Base
- High Density Polymer Seat And Back
- 10" Height Adjustment Range: Seat Adjusts From 22" - 32"
- Overall Dimensions: 17" W x 16 1/2" D x 32" - 41 3/4" H

153763 \$77.99

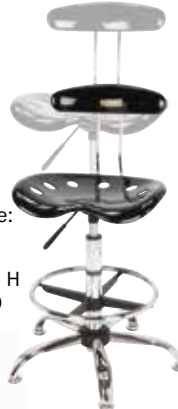

Dust Brushes

A standard style bench brush with durable horsehair bristles and a smooth wood handle. The fine horsehair bristles provide scratchless dusting on even the most polished surfaces. Brush is 13 3/8" long with four rows of 2 1/4" long bristles and a 1 3/4" wide handle.

153695 (A) bench brush..... \$11.25

154581 (B) draftsman brush..... 1/2" x 10" w/2 1/8" long bristles... \$6.50



Akro-Mils® 24" Tool Storage Rack

All shops have a problem with tools that we use a lot just lying on precious work surface space. This is 24" tool rack is a quick way to provide storage for tools that are used every day in your shop or garage. A multi-level design stores up to 96 tools. The durable polypropylene material will make this tool rack last and will not bend or warp over time. tools and mounting hardware not included. Size: 24 1/8" W x 6" D x 2 3/4" H. Made in the USA.

154658 24" Tool Rack \$7.99

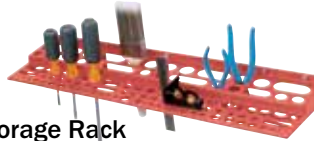

WoodRiver® Precision Craft Knife

Our Precision Craft Knife has a solid aluminum handle with a rubber finger grip and comes with six different really sharp blades in a plastic storage case. The blades also take an edge really well with re-sharpening on any fine stone.

159343 \$6.99



PERFORMANCE TOOL Cord Reels

Tired of dragging your electric cords from one side of the garage or shop to the other and then coiling them up to put them away? Let our cord reel do it for you. Performance Tool's 25' or 50' reel can be hung from the ceiling or wall with its included bracket. Just pull out the amount of cord you need, and when you're done, give it a tug and the cord reel will retract (don't let go) the cord.

160674 25' reel x 16 gauge \$56.99

160673 50' reel x 18 gauge..... \$74.99

Dead Blow Mallets

These mallets feature a non-marring head which is shot filled to deliver a solid, no bounce strike. Perfect for assembly and disassembly operations and available in three sizes.



15F16 (A) 10 oz. \$13.99

15F17 (B) 14 oz. \$19.99

15F18 (C) 28 oz. \$22.99

15F20 Set of three..... Save! \$41.99



Pica-Dry® Longlife Automatic Pen

This versatile pen marks and writes on all surface materials, as well as dusty, raw, oily, wet and dark surfaces, and can be wiped off glossy surfaces with a wet tissue. Features include: automatic lead support - stainless steel tube, built-in sharpener in the front of the cap, and convenient quiver cap with special clip. Water-soluble refills in assorted colors are available by the pack (160112).

160111 Pen \$14.99

160112 Refill-assorted colors \$9.99

161756 Refill-white NEW! \$9.99



WoodRiver® Silicone Funnel

Our soft, nonstick Silicone Funnel is perfect for transferring glue or any other liquid from one bottle to another, and it collapses nearly flat so it's easy to store. The small end or bottom of the funnel is 5/8" square; top or opening is 3" across. This funnel is NOT approved for contact with food.

160250 each \$1.99

Shop Accessories



Spring Loaded Letter and Number Punch Set

Place this punch on your work and press - the spring-loaded handle "hammers" your punch mark for you! Just insert one of the hardened punches into the brass handle, adjust the amount of tension needed to mark your wood or soft metal, and press down on the handle to mark. Set contains handle, 26 letters, 9 numbers, decimal point, ampersand, and plastic storage case. Letters/numbers are 4mm tall by 3.5mm wide with plastic storage case.

129270\$23.99

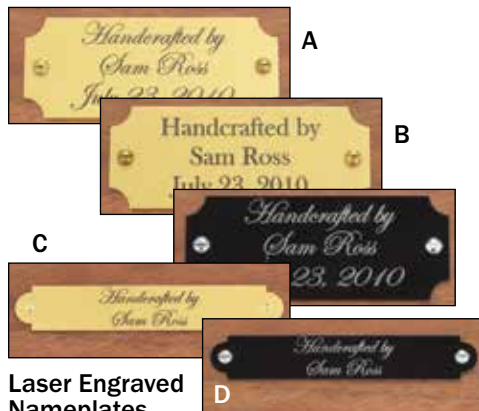

Laser Engraved Nameplates

These beautiful nameplates are made from .020" aluminum plate and are available in either Gold plate with Black lettering, or a Black plate with Silver lettering. When ordering, clearly type your inscription (any message you want) in the message line box. Maximum of 3 lines with 20 characters per line, including letters, numbers, periods and spaces for the 1" x 2 1/2" plates. Maximum of 2 lines with 24 characters per line, including letters, numbers, periods and spaces for the 1/2" x 3" plates. Includes fasteners. **Specify capital or lowercase letters. Since each plate is custom laser engraved, we cannot accept cancellations or returns.**

152722 (A) 1" x 2 1/2", gold w/black\$5.29
 152723 (B) 1" x 2 1/2", black w/silver\$5.29
 152724 (C) 1/2" x 3", gold w/black\$4.79
 152725 (D) 1/2" x 3", black w/silver\$4.99

Catalog items with this logo can be laser engraved, call 800 535-4488 for info.



Custom Laser Engraving

Customize or personalize your tools with our new laser engraving service. Prices are per line engraved. We will choose the location of the engraving unless you specify your preference. Quantity pricing is for 5 or more *duplicates of the same message*. Since each tool is custom engraved, we cannot accept cancellations or returns.

149258 (A) serif style	Per Line	5+ Lines
149259 (B) script style	\$1.99	\$1.79
149840 engr. tools purchased from Woodcraft	\$1.99	\$1.79
149841 engrave other tools	\$2.50	\$2.25



Satin Brass Engraved Nameplates

Nameplates are solid brass, with a soft satin finish. Lacquer coating. Includes brass pins or screws.

Clearly print your inscription on the catalog order form page. Maximum 20 characters per line, including letters, numbers, periods and spaces. Specify capital or lowercase letters. Since each plate is custom engraved, we cannot accept cancellations or returns. Quantity pricing is for duplicates of the same message.



Small Satin Brass Plates

measure 1/2" x 3"	Per Plate
145873 1 line	\$4.50
145874 2 lines	\$4.50

Large Satin Brass Plates

measure 1" x 2 1/2"	
145875 1 line	\$4.99
145876 2 lines	\$4.99
145877 3 lines	\$4.99

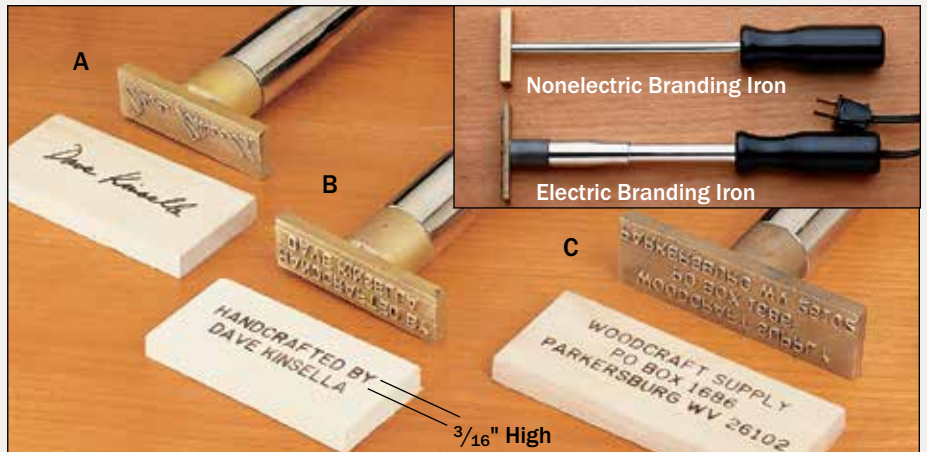

Branding Irons

We offer a variety of styles to meet your workshop needs. Clear brands can be made in wood, leather, cork, or canvas. When ordering please neatly print on the order form the imprint you want. When counting characters, include periods and extra spaces. Capital letters only. Since each iron is custom made, we cannot accept cancellations or returns unless defective. Allow 6-8 weeks for delivery.

Electric Branding Irons

Feature ceramic-insulated, nickel-chrome heating elements which deliver up to 955°F heat. Positive grip, heat-resistant handles keep hands cool. Rated 125 watts, 120 VAC with 2-wire cord set 4' 6" long. Solid brass heads are individually engraved with 3/16" high capital letters and numbers (except logo/signature model). Allow 6-8 weeks for delivery.

(A) Electric Logo/Signature Branding Iron. Have your distinctive design engraved. Note: very small details cannot be reproduced. Send clear black and white camera ready artwork to fit a 1" high x 2 3/4" wide, 1 1/2" x 2", or 1 3/4" x 1 3/4" area.

49D13\$279.99

(B) "Handcrafted By ..." Branding Irons. Add your name on the second line and proudly mark everything that leaves your shop! Available with up to 20 characters on 2nd line. Print the name you want on the iron clearly on your order form or just tell the operator when you call (800 225-1153).

49D11 electric model\$89.99

49E12 nonelectric model\$69.99

(C) Personalized Electric Branding Iron for two or three lines of your copy. Each line can have up to 20 characters for your name, address, special message or instructions. All capitals, letters, or numbers.

49D14 2-line branding iron\$99.99

129219 3-line branding iron\$119.99

Nonelectric Branding Iron

Electric Branding Iron

3/16" High

Branding Iron Date Attachment allows you to date your projects. Kits may be used with nonelectric branding iron (49E12) and come with numbers for the years 2001 through 2032. Complete with instructions, attachment heads and

all necessary screws.

123038 nonelectric\$50.50



(D) Branding Iron features 3/8" engraved letters or numbers on a brass head. Plated steel shaft and hardwood handle keep your hand cool when heating on open flame (propane torch, charcoal grill, fireplace, etc.). Available in 1 to 12 characters, one line only.

49A11 1-3 letters/numbers\$49.99

49A14 4-6 letters/numbers\$49.99

49A17 7-9 letters/numbers\$49.99

49A20 10-12 letters/numbers\$49.99

(E) Electric Initial Branding Iron Kit features a solid brass head with up to three 3/16" capital numbers or letters. Includes storage case and three accessory tips for general purpose soldering and burning. 900°F tip, 110 volts. Extra heads with your choice of brand simply screw into iron.

49A30 complete kit Save!\$49.99

49A25 branding iron only\$42.99

49H13 extra head only\$37.99



Simply better.



BESSEY® Parallel Clamps, K-Body®REVO™, Vario K-Body®REVO™

The large, flat parallel clamping surface made of impact and break resistant polyamide comes with replaceable pressure caps that resist glue, paint and solvents. The unique internal mechanism ensures accurate 90° angles that are very sturdy, even at maximum pressures up to 1,500 lbs. Large 2K composite handles have a quick-release feature for fast action. Rail protection pieces made of same glue resistant polyamide elevate work piece from the rail. Removable end rail clip ensures clamp sits parallel to the rail and can easily be removed to reverse sliding arm for use as a spreader.

- 12" REVO **149516** pair..... **\$96.80**
- 24" REVO **149517** pair..... **\$97.98**
- 31" REVO **149518** pair..... **\$105.98**
- 40" REVO **149519** pair..... **\$115.98**
- 50" REVO **149520** pair..... **D/S \$124.40**
- 60" VARIO **149961** pair..... **D/S \$149.99**
- 149521** pair..... **D/S \$129.99**
- 03W68** KP block set, 4-pcs. **\$24.99**
- 842045** tilting jaws, pair **\$12.99**
- 842283** TK6 table clamps, pair..... **\$8.50**
- 842279** jaw protection pads, pair... **\$8.99**
- 842281** rail protection pieces, pair **\$5.50**
- 842280** end rail clip, single **\$5.50**
- 149962** jaw clamp spindle..... **\$30.50**
- 149963** sliding jaw end **\$17.99**



BESSEY® K-Body REVO™ Jr.

These powerful jaws exert up to 900 lbs. of force. These clamps are up to 30-40% lighter than all other parallel clamps claiming the 900-lb. rating. K-Body®REVO™ clamps are assembled in the USA.

- 152985** Revo Jr. 12", pair **\$59.98**
- 152989** Revo Jr. 24", pair **\$74.70**
- 152991** Revo Jr. 36", pair **\$85.45**

D/S = Item drop ships direct from manufacturer.

BESSEY® Tradesman™ Bar Clamps

The original design is unmistakable with its patented nonslip locking mechanism. These clamps have greater holding power than any "clutch-style" clamp, and feature reinforced malleable cast iron jaws and sliding arms, high quality profiled rails, smooth running spindles with Acme thread, large ergonomic 2K composite handles with a comfort insert, and glue resistant nonmarring plastic caps.

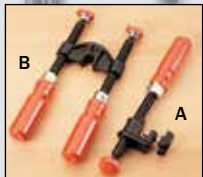

Tradesman Medium Duty Clamps with 1" x 1/4" rail size and nominal clamping pressure of 600 lbs.

Capacity	Throat Depth	Each	6+
141413	6".....2 1/2"	\$13.50	\$12.15
141414	12".....2 1/2"	\$14.50	\$13.05
141415	18".....2 1/2"	\$15.50	\$13.95
141416	24".....2 1/2"	\$17.50	\$15.75
141417	30".....2 1/2"	\$19.50	\$17.55
141418	36".....2 1/2"	\$20.75	\$18.67

Tradesman Heavy-Duty Clamps with 1" x 5/16" rail size, and nominal clamping pressure of 800 lbs.

Capacity	Throat Depth	Each	6+
141419	8".....4"	\$22.99	\$20.69
141420	12".....4"	\$25.99	\$23.39
141421	16".....4"	\$29.99	\$26.99

Tradesman Extra Heavy-Duty Clamp with 1 1/4" x 3/8" rail size and nominal clamping pressure of 1,320 lbs.

Capacity	Throat Depth	Each	6+
141422	12".....5 1/2"	\$30.99	\$27.89

Edge Clamps increase the versatility of sliding bar clamps.

Capacity	Throat Depth	Each	6+
141516	(A) single screw	\$12.50	
141517	(B) double screw	D/S \$19.99	



Mighty Mini™ Light Duty, Zinc Die Cast Clamps

Traditional F-style or Step Over style for versatile clamping at a value price. Clamp pressure to 330 lbs.

Traditional F-style

Capacity	Throat Depth	Each	6+
130926	4".....2"	\$8.99	\$8.09

BESSEY® EZS One-Handed Quick-Action Bar Clamps

This extremely sturdy original BESSEY® EZS clamp is perfect for all work that needs to be carried out with one hand. The release mechanism allows for quick and easy transformation from clamping to spreading. A 2-component plastic handle with pump lever is positioned behind the rail, enabling a powerful grip and the achievement of 445 lbs. of constant force.

Capacity	Throat Depth	Each	4+
845103	6".....3 1/8"	\$19.99	\$17.99
845104	12".....3 1/8"	\$25.50	\$22.95
845105	18".....3 1/8"	\$27.99	\$25.19
845106	24".....3 1/8"	\$29.99	\$26.99
845107	36".....3 1/8"	\$31.99	\$28.79

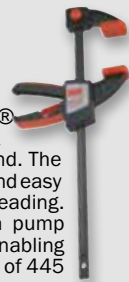

BESSEY® Vario Strap Clamp

23" long x 1" wide, high-tensile strength polyester "no stretch" strap. "Vario-angles" exert continuous pressure on the joints. Winding gears draw the strap evenly from both sides.

- 127924** strap clamp **\$45.75**
- 127933** vario-angles (6) **\$15.25**



BESSEY® H-Series Pipe Clamps

The unique foot design provides dual-axis stability, and the long legs raise your project off the work surface so tightening the clamp is easier.



- | | Each | 4+ |
|---------------------------------|----------------|----------------|
| 147891 1/2" fixture..... | \$13.25 | \$11.92 |
| 147892 3/4" fixture..... | \$15.25 | \$13.72 |



BESSEY® Auto-Adjust Toggle Clamps

Automatically adjusts to variations in workpiece dimensions while maintaining constant clamping force. The removable, non-marring plastic cap is included. Can be adjusted to create an actually applied clamping force from 25 to 550 lbs. (max holding capacity 700 lbs.). One BESSEY Auto-Adjust Toggle Clamp can replace a range of competitive clamps.

- 152928** (A) 1 9/16" Horiz. toggle clamp **\$19.99**
- 152929** (B) 2 3/8" Horiz. toggle clamp **\$19.25**
- 152930** (C) 1 3/16" Inline toggle clamp **\$22.50**



BESSEY® F-Style Bar Clamps

have cast heads, coated steel bars, wooden handles and swivel pads. Bar size is 1/4" x 3/4".

Capacity	Throat Depth	Each
146980	6".....2 1/2"	\$9.50
146981	12".....2 1/2"	\$10.99
146982	18".....2 1/2"	\$12.50
146983	24".....2 1/2"	\$13.99
146984	30".....2 1/2"	\$14.99

Bar Clamp Set 2 each 12", 24", and 30" clamps.

Double Headed Bar Clamps Fixed jaw with two clamping surfaces to distribute force over larger area.

Capacity	Throat Depth	Each
838432	12".....3 1/2"	D/S \$16.99
149957	24".....3 1/2"	D/S \$18.99

Heavy-Duty Bar Clamps Similar to above but with a 3 1/2" deep throat and heavier bar (5/16" x 7/8").

Capacity	Throat Depth	Each
146986	18".....3 1/2"	D/S \$27.99
146987	24".....3 1/2"	D/S \$27.99

Deep Throat Heavy-Duty Bar Clamps Same as Heavy-Duty Bar Clamps but with a 5" deep throat.

Capacity	Throat Depth	Each
842371	12".....5"	D/S \$27.99
842372	18".....5"	D/S \$34.99
149956	24".....5"	D/S \$37.99

Vises & Clamps



True Position Hardware Jig

For professional installation of handles and knobs, this jig works on doors and drawer fronts and is an invaluable tool for any cabinet installer. Simply slide guides and stop along English and metric rulers, tighten thumb screws, and drill. Locates hardware holes of any dimension on doors and drawer fronts. Includes standard 5mm drill bit (approximately 3/16"). Durable lightweight aluminum with case hardened steel bushings. Made in the USA.

848445 Model TP1934..... **\$194.99**



Euro Handle-It Handle and Knob Drilling Jig

As simple as the name implies, this is the go-to tool for installing handles and knobs. Even if you are only installing a few, this economical jig makes the job quick and easy. A V-notch in the fence is for installing handles at a 45° angle, and English and metric scales allow for work on all handles. Jig installs handles as large as 24" (600mm). Drawer features: height adjustment to center of a 12" high drawer front; center reference line for extra wide drawer fronts; and movable positioning stops for use on drawer fronts of the same size. Made of polycarbonate aircraft canopy material (jet aircraft canopy material), this tool is virtually unbreakable. Comes with simple instructions.

826601 **\$59.99**



Adjustable Alloy Bar Clamps

These bar clamps are made of high quality extruded aluminum for both light weight and strength. The head of the clamp is riveted for rigidity, and the adjustable foot wraps fully around the bar for tight clamping action. Detents are spaced 5/8" apart for quick adjustments. The clamp sits upright and is well balanced for ease of use. These clamps have a large "wing" type knob for good clamping pressure without causing fatigue. Made in USA.

	Each	6+
811661	24".....	\$29.39 .. \$26.45
811662	36".....	\$34.50 .. \$31.05
811663	48"	\$34.69 .. \$31.22



Drawer Slide Mounting Tools

No matter if you're a novice or a pro, you don't want the tedious task of measuring and marking every slide. These tools will make for easy installation and smooth operation.

Drawer Slide Mounting Tool

The Drawer Slide Mounting Tool is designed to easily install metallic drawer slides. No matter if you're a novice or a pro, you don't want the tedious task of measuring and marking every slide. This tool eliminates all that. It uses the intersection of the stile and rail as a reference point so that each cabinet track is easily mounted accurately. It works just as well with frameless cabinets. This one tool can install the most popular metallic slides on the market.

161798 (A) **\$29.99**

Drawer Mounting Brackets

The Drawer Mounting Brackets are designed to ease the process of aligning a full-extension drawer slide to the drawer box once the slide has been mounted into the cabinet. Brackets are designed to work with both face frame and frameless cabinets

161799 (B) **\$14.99**

Euro Easy-Drill Concealed Hinge Boring Jig

The Easy-Drill Boring Jig quickly drills for all brands of hinges. It locates all brands of mounting plates and can be used over and over. The "V" locator works off a reference line. It is adjustable from door edge to cup hole. The Easy Drill is made of high-impact polycarbonate. Comes with simple instructions.

141529 **\$11.99**



Pinnacle® Cam Clamps

These versatile, maple clamps are widely used by furniture restorers, cabinetmakers, luthiers and hobbyists. Light in weight with a quick cam action that produces 330 lbs. of pressure when fully cocked. Bar is made of spring steel; all sizes have cork faces to prevent marring and staining. Made of lacquered maple.

	Throat	Open	Each	4+
	Depth Capacity			
123262	4 1/2"	8"	\$18.89	\$17.00
123263	6"	8"	\$18.89	\$17.00
123264	8 1/2"	8"	\$19.99	\$17.99
123265	4 1/2"	16"	\$20.99	\$18.89
123266	4 1/2"	24"	\$26.29	\$23.66



Pinnacle® Wooden Handscrews

Durable, oiled, hard maple jaws will not mar the work and are less likely



to slip than steel jaws. The deep throat applies pressure to a broad area of evenly or concentrated at one point of contact. Drawn carbon steel screws pivot to allow the jaws to grip nonparallel surfaces. Made in USA.

	Jaw	Throat	Open	
	Length	Depth	Capacity	
148587	4"2"	... 2 1/4"	\$15.79
148588	6"3"3"	\$18.89
148589	8"4"5"	\$22.09
148590	10"5"7"	\$25.19
148591	12"6"	... 9 1/4"	\$28.39

Metal 1/2" Spring Clamps

These small spring clamps can be used almost anywhere. Made from lightweight metal with black plastic tips. Each clamp is 2" long x 1/2" wide, with a 1/2" jaw opening. 15 per pack.

157847 **\$12.99**

TRIM CLIP Miter Clip And Miter Aid

Miter Clip makes achieving tight glue joints easy. Our clamp stays open effortlessly and allows for easy adjustment of the workpiece. With a patented I-beam construction and reverse cam action, Miter Clip provides even pressure on the joint and is capable of large miter applications.

Miter Aid was developed by a contractor with over 25 years of experience and 25 years of frustration caused by the lack of a reliable method to accurately measure trim for windows and doors. He took it upon himself to design this tool that allows anyone to precisely measure even the longest pieces of trim the first time and every time, thus eliminating the need for multiple cuts and wasted trim.

154579 (A) Miter Clip..... **\$17.99**

154578 (B) Miter Aid **\$15.99**

Spring Miter Clamp Set

The quickest and easiest way to clamp mitered corners! Great for moldings and trim. Simply choose the appropriate size spring clamp, and use the spreader to open and position the clamp. Kit includes spreader, 8 each of $\frac{3}{8}$ "- $\frac{5}{8}$ ", $\frac{5}{8}$ "-1", $\frac{3}{4}$ "- $1\frac{1}{4}$ ", $1\frac{1}{2}$ "- $1\frac{3}{4}$ ", 2 "- $2\frac{3}{4}$ ", and $2\frac{1}{2}$ "- $3\frac{1}{2}$ " spring clamps and a form-fitted case.

145691 \$58.99

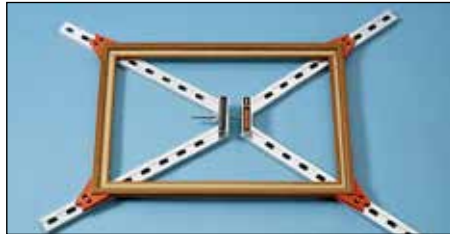

Self-Squaring Frame Clamp

Tightens all four corner joints equally and simultaneously with just the turn of a central wing nut. Jaws leave joints visible for inspection, easily adjust to accommodate frames from 5" x 7" to 26" x 30". Aluminum with glue-resistant plastic jaws.

08A62 \$34.69
08A62C extra corners (4) \$4.99



Picture Frame Miter Clamp

Easily clamps all styles of picture frames up to 48" x 48". Plated rods are fully threaded and thumb nuts make accurate adjustments of the corners quick and easy. Also clamps small boxes and furniture.

07S51 \$29.99



Corner Band Clamp

Picture frames, hexagon, circular and just about any other shape, can be securely held with this clamp. The 6' nylon strap is neatly contained in its own reel, and 4 variable angle pads allow virtually any shape to be clamped. Just fit the strap around your work, flip the strap locks and turn the clamp handle to apply pressure equally around your project. Extra corners are available for projects with more than four sides.

141115 \$22.59
141211 extra corners (4) \$6.89

Quick Clamping Action Adjustable Pressure

Quick Action Toggle Clamps

Install on jigs, tool fixtures, or moveable bases so they can be quickly set and engaged to hold your work. Three different styles, each complete with adjustable rubber pressure tips. Mounting screws are not included.

(A) Vertical Handle Toggle Clamps apply vertical clamping pressure with handles that lock in a vertical/up position. Best used when positioned away from the operator; handle can be pulled up into locking position, or pushed back to release.

	Lbs. Holding Capacity	L x H Closed	Each	4+
144312	100	$2\frac{1}{8}$ " x $3\frac{1}{8}$ "	\$12.59	\$11.33
143934	200	$2\frac{3}{4}$ " x 4"	\$14.19	\$12.77
144313	500	$4\frac{3}{4}$ " x 6"	\$18.89	\$17.00
143935	750	$5\frac{3}{4}$ " x $7\frac{1}{2}$ "	\$20.99	\$18.89

(B) T-Handle Vertical Toggle Clamps are constructed exactly like the vertical toggle clamps but have a lower profile T handle for easier gripping both in front of and behind the jig or fixture.

143937 200 3" x 3" \$17.39...\$15.65

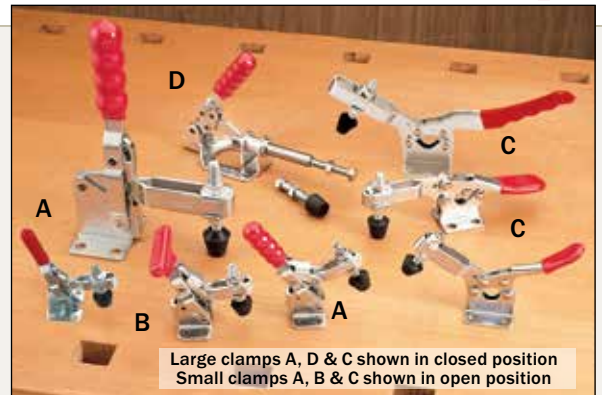

Large clamps A, D & C shown in closed position
 Small clamps A, B & C shown in open position

(C) Low Silhouette Toggle Clamps provide vertical clamping pressure with locked handles in a horizontal/down position. Useful where clear work space is required.

	Lbs. Holding Capacity	L x H Closed	Each	4+
143938	200	6 " x $1\frac{3}{4}$ "	\$14.19	\$12.77
143933	500	$6\frac{1}{2}$ " x $1\frac{3}{4}$ "	\$19.49	\$17.54
144314	750	$11\frac{3}{4}$ " x $2\frac{1}{2}$ "	\$18.89	\$17.00

(D) Straight Line Toggle Clamps are for push clamping operations such as keeping stock tight against fences for drilling or cutting.

143936 300 ... $6\frac{3}{4}$ " x $3\frac{1}{4}$ " \$15.79...\$14.21

Light Duty Mini F-Clamps

A light-duty F-Clamp is a standard for any shop. These clamps feature standard working capacities and a rust-resistant chrome plated rail, ensuring years of service in your woodshop or garage doing the work of small clamps in a fraction of the time. Each F-Clamp has a $\frac{2}{4}$ " throat depth, wooden handle, plastic protective working pads and a working capacity of 250 lbs.

157911 12" mini F-Clamp \$9.99

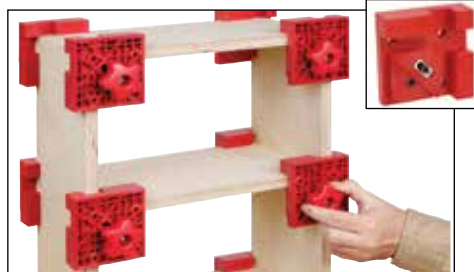

Woodpeckers® BC4-M2 Box Clamp

Woodpeckers® clamping accessory, the BC4-M2 Box Clamp, is a simple device that eliminates the hassle of using heavy, expensive bar clamps for assembling boxes, drawers or full-sized cabinets. The Box Clamp is molded from a special combination of glass reinforced polycarbonate and includes hardware for use by hand or with fixtures. The clamp will accommodate materials from $\frac{1}{4}$ " up to 1" in thickness. Sold in pairs. Made in the USA.

153667 \$36.99

JEVONS 3D Squares

These heavy aluminum jigs are machined square to within .002" along the entire 6" leg, and designed to easily clamp on to a project making it simple to square up corners. Six inch long sides give plenty of clamping room so that when square is reached, it is kept until gluing and fastening are complete. Use for squaring up carcasses, bookcases, or as part of a jig on a table saw. They make great holders/braces for high auxiliary fences for cutting raised panels. Each leg has countersunk screw holes to facilitate easy jig assembly. Once you have them, you'll discover more uses almost daily. Sold as a set of two. Clamps sold separately.



144041 \$34.69 \$31.22



Pinch Dogs Pull Joints Together

When driven into end grain along a joint, these simple steel "clamps" draw boards tightly together for gluing up panels, table or benches, and can be used again and again. Pack of 10.

140113 $1\frac{1}{2}$ " \$23.50
140114 2" \$32.99

Vises & Clamps

Laminated Maple Benchtop

Build your own workbench with one of these 1 3/4" thick, rugged slabs of maple laminated into a single, warp resistant, self-supporting panel creating the perfect work surface. Accurately machined and sanded satin smooth, just attach vises and bore dog holes. These tops are also perfect for kitchen work surfaces, coffee tables and bars. Ultraviolet cured acrylic finish is resistant to water, alcohol and solvent detergents.

- 145685 24" x 60", 70 lbs. \$219.99
- 145686 30" x 60", 88 lbs. \$269.99
- 145687 24" x 84", 98 lbs. \$299.99



Birch Workbench Top

1 1/2" x 27" x 60"

This heavy-duty, 100% hard-wearing solid Birch top is perfect for use in your shop or home. The topside is graded AB and the underside C. It is unfinished and sanded on both sides to 150 grit.

- 161270 \$169.99



WoodRiver® Patternmaker's Or Gunstock Carving Vise

The body of this heavy cast-iron vise swivels 360° so you can always position your work where you need it. The 4 7/8" wide jaws open to 6", and both jaws swivel so you can clamp virtually any shape. Perfect for holding table legs for shaping or carving. Secured to any bench or tabletop up to 4 1/2" thick by a heavy threaded rod (which requires a 3/4" hole) and large winged nut, so it can be quickly set up and removed as needed.

- 142768 \$134.99



WoodRiver® Universal Vise

The 3 1/2" wide by 2 1/8" high jaws have a 5" open capacity, in either a vertical or horizontal position.

The faces are drilled to accept wood facings, there is a small anvil, and the vise rotates 360° on its base, locking tight as soon as an item is secured in the jaws. Bolt holes in the base legs make it easy to attach the vise to a benchtop.

- 144592 \$64.99
- 823371 tilting jaws set (not shown) \$16.99

Auto-Pro Dog Clamping System

Armor Tool's patented Auto-Adjust Technology mounted on a dog peg. Clamps rotate 360°, allowing for a wide range of clamping applications. In-Line Dog Clamp is fitted with a split dog peg that inserts and tightens into most dog holes. Horizontal Dog Clamp is fitted with a 3/4"-diameter, 7 1/2"-long spiral aluminum dog peg that inserts into a dog hole. Peg Fences easily slide into a table and allow you to brace materials or set up corners. Dog Brackets contain dog holes that accommodate both Dog Clamps. Interchangeable dog

- 160635 (A) In-Line Dog Clamp \$33.99
- 160636 (B) Horizontal Dog Clamp \$37.99
- 160637 4" Dog Fence \$14.99
- 160638 (C) 8" Dog Fence \$17.99
- 160639 14" Dog Fence \$19.99
- 160640 (D) 4" Dog Bracket \$19.99
- 160641 (E) 12" Dog Bracket \$34.99
- 160642 (F) 3/4" x 3" Dog Peg \$6.99
- 160643 3/4" x 7 1/2" Dog Peg \$8.99
- 160644 20mm x 3" Dog Peg \$6.99
- 160645 20mm x 7 1/2" Dog Peg \$8.99

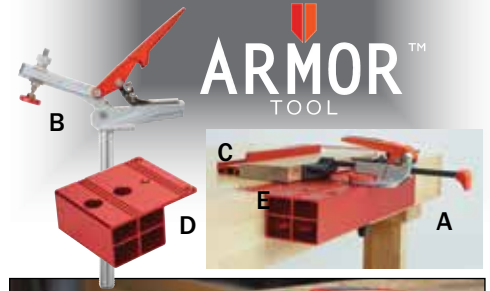

Auto-Pro Auto-Adjust Toggle Clamps

Armor Tool's patented Auto-Adjust Technology means that the clamp maintains consistent pressure while automatically adjusting to different-size workpieces. Rotate the adjustment screw to achieve the required clamping pressure. Choose from medium, low or high profile horizontal toggle clamps and in-line toggle clamp. All toggle clamps have horizontal mounting plates.

- 160647 (G) Low Horiz. Toggle Clamp \$24.99
- 160646 (H) Medium Horizontal Toggle Clamp \$24.99
- 160648 (I) High Horizontal Toggle Clamp \$25.99
- 160649 (J) In-Line Toggle Clamp \$26.99

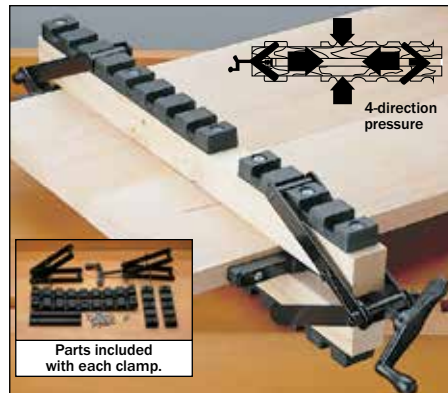
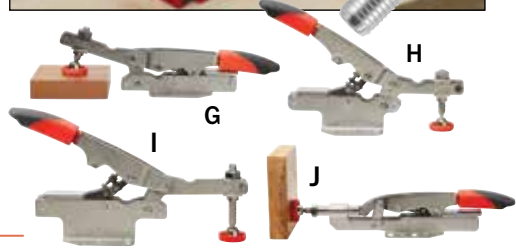
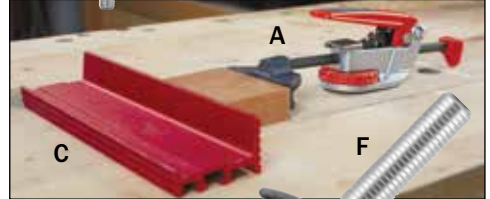

WoodRiver® 4-Way Pressure Clamps

Eliminates Buckling When Gluing Large Panels! WoodRiver 4-Way Pressure Clamps apply equal pressure from all four directions (top, bottom, and both sides). Ideal for gluing tabletops, shelving, veneer, and laminates. Attach clamps to any length 2 x 2's (a 2 x 4 ripped in half) with screws provided, set jig and turn handle to tighten (on large pieces, position every 12"-18" for maximum clamping efficiency). Clamp has plastic pressure pads and two 19 1/2" tail bars of tough plastic with 12 notches to handle a variety of stock widths. It can be used on boards up to 6" thick. Comes with complete instructions, 2x4's not included. Replacement "long" and "short" notched plastic clamping bars sold in pairs.

- 125392 Each 3+ \$31.50 \$28.35
- 125398 long bar (2) \$5.29 \$4.76
- 125397 short bar (2) \$3.69 \$3.32

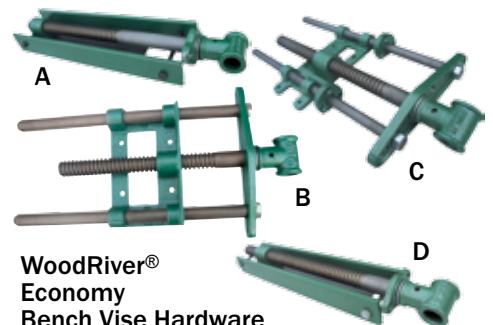

WoodRiver® Economy Bench Vise Hardware

Improve your current bench by adding a front vise or use this economical hardware to build a new bench from scratch. We're sure you'll find that the rugged castings and precision parts make these economically priced workbench vises a fantastic value. Handle not included.

- Small End Vise Slide with 1" dia. x 14" L screw and 4" W x 15" L vise.**
- 144806 (A) \$64.99
- Small Front Vise with 1" dia. x 10" L screw, 3/4" dia. guide rods and 9" W x 13" L vise.**
- 144804 (B) \$69.99
- Large Front Vise with 1 3/16" dia. x 15 1/2" L screw, 3/4" dia. guide rods and 10 1/4" W x 19 1/4" L vise.**
- 144805 (C) \$104.99
- Large End Vise Slide with 1 1/4" dia. x 17 1/2" L screw and 4" W x 19 5/8" L vise.**
- 144807 (D) \$79.99

Vise Handles

- 17E46 small, 7/8" D x 11 1/2" L fits 144804 & 144806 \$6.99
- 17E52 large, 1" D x 13 1/2" L fits 144805 & 144807 \$8.50

www.woodcraft.com

ECLIPSE Quick Release Bench Vises

These Eclipse vises feature a quick-action lever which disengages the vise screw and permits instant adjustment to any point along the vise's capacity. This unique design characteristic ensures a smooth, efficient operation that will make these vises the most versatile and frequently used tools in your workshop. Heavy cast iron jaws and solid steel slide rods ensure a lifetime of rugged use, and vise jaws are toed in to assure positive clamping, even under the heaviest of clamping pressure. The large jaw opening allows for outfitting the cast jaws with wider, heavier wooden jaws to provide the increased clamping pressure necessary to firmly secure heavy workpieces. Designed with the woodworker in mind, a built-in dog may be extended and used in combination with a bench dog to offer alternate uses. Eclipse vises are easily mounted to virtually any style of workbench and can be used in any configuration you choose.

- 152633 7" wide jaws \$132.50
 152634 9" wide jaws \$144.89
 152635 10" wide jaws \$159.99



ECLIPSE Portable 6" Hobby Vise

This vise is ideal for the beginning woodworker or hobbyist. Body and jaws are quality castings fitted with two steel slide bars, an Acme threaded main screw, and steel sliding handle. Features include an integral clamp for benchtops up to 2 1/4" thick, and has predrilled holes for permanent bench mounting. Jaws are 6" x 2", open to 5", and are predrilled for the addition of wooden faces.

- 154141 \$34.99



Quick Release Front Vise

Features a machined pivoting nut that engages or releases with a turn of the 1" diameter main screw. 20mm diameter guide rods. Screw and body length 19", width 10 1/2". Made in Germany. Handle and mounting screws not included.

- 17A11 \$229.99
 17E52 wood handle \$8.50



Economy Quick Release Front Vise.

Virtually identical to the hardware above, but made in China.

- 145444 \$78.99
 17E46 wood handle \$6.99

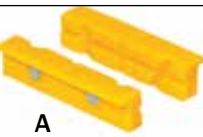

Maple magnetic jaw inserts shown, no longer available



WILTON Woodworker's Vise

Features fully enclosed screw threads. Front jaw pivots 12° and the entire front jaw can be "lifted" up and locked in place to serve as a full-length dog. Jaw width 4" x 7", max. opening 10", 29 lbs. Complete with mounting instructions. Optional maple magnetic jaw inserts no longer available.

- 126504 Wilton vise D/S \$215.99

BESSEY Nylon Magnetic Vise Jaw Inserts

- 418581 (A) fits most 3"-6" jaws D/S \$15.99



KREG® Automaxx® Bench Clamps

Automaxx® Bench Clamps make benchtop clamping faster and easier than ever. That's because Automaxx Bench Clamps adjust automatically to clamp materials that are thin, thick, or in between. The 3" reach for face members 2" and narrower, automatically adjusts to any material thickness up to 3 3/4" while the 6" reach for face members 2" and wider, automatically adjusts to any material thickness up to 5". The 3" Bench Clamp System includes a 3" x 4" x 1/4" aluminum plate while the 3" HD Bench Clamp System includes a 10" x 10" x 1/4" powder-coated steel plate. Add another clamping location to your bench or table with the installation of additional Clamp Plates or create a clamping station with the addition of the 33 3/4" long Clamp Trak, each sold separately. Universal Clamp Trak Kits include two lengths of Clamp Trak and mounting hardware to make your own Clamp Table. Automaxx Clamp Vise includes 3" Bench Clamp, Clamp Vise Plate, two Clamp Blocks, two Bench Dogs, two Bench Brakes, installation hardware and instructions.

- 162016 3" Automaxx bench clamp \$34.99
 162017 6" Automaxx bench clamp \$39.99
 162018 3" bench clamp system \$49.99
 162019 3" HD bench clamp system \$64.99
 146157 additional 3" x 4" clamp plate \$13.99
 148164 33 3/4" long clamp trak \$44.99
 161429 27" x 45" clamp trak kit \$99.99
 161430 27" x 69" clamp trak kit \$139.99
 162020 Automaxx clamp vise \$59.99

KREG® Automaxx®

Clamp Table

Combines the versatility of Automaxx® Bench Clamps with the convenience of an extruded aluminum Clamp Trak that is securely bolted to a 1" thick support panel. Bench Clamps apply an incredible amount of pressure to the joint line. Perfect as a pocket-hole assembly station or as a general hold-down. Each Clamp Table Top includes two 3" Automaxx Bench Clamps which rotate 360° on the Clamp Traks and can be moved along the extrusions that line the left and bottom sides of the table. The 21 3/4" x 33 3/4" Clamp Table surface is constructed of melamine material which sheds dried glue quickly and is easily replaced.



- Five Clamp Blocks included with the Clamp Table Top can be oriented for face frame widths of 1 1/2", 2", 2 1/2" or 3" such that the components of the frame can be loaded on the table and held square. Add 6" Automaxx Bench Clamp for expanded versatility. The Multi-Purpose Steel Stand is adjustable from 29" to 35" in height and is powder coated for durability. The Clamp Table Combo includes Clamp Table Top and Multi-Purpose Steel Stand. Add the optional Kreg Casters Set for convenient mobility.
- 162015 Automaxx Clamp Table Top... \$249.99
 160627 Multi-Purpose Steel Stand \$149.99
 162014 Clamp Table Combo \$399.99
 148165 Extra Clamp Blocks \$14.99
 148166 Kreg Casters Set (4) \$59.99

Vises & Clamps

KREG® Automaxx®

Wood Project Clamps

Automaxx® Project Clamps utilize the same technology to make clamping fast and foolproof – locking closed easily, and consistently every time and with every thickness. These clamps have large pivoting jaws with added pads for aligning face joints and comfortable handle grips for reduced hand fatigue. The 3" reach for face members 2" and narrower automatically adjusts to any material thickness up to 3", while the 6" reach for face members 2" and wider automatically adjusts to any material thickness up to 5".

- 162021 3" Automaxx project clamp \$29.99
 162022 6" Automaxx project clamp \$37.99

KREG®

Universal Bench System

With 15 size options and two adjustable heights, you can easily create a workbench, tool stand, assembly table, or clamping table – from 14" x 14" up to 64" x 64". Use the predrilled holes to customize the bench even more, and add a benchtop to suit your needs.



- 157850 29" adjustable steel leg set (4) \$79.99
 157851 15 1/4" adj. steel leg set (4) \$64.99
 157852 14" universal bench rail set (4) \$20.99
 157853 20" universal bench rail set (4) \$27.99
 157854 28" universal bench rail set (4) \$33.99
 157855 44" universal bench rail set (4) \$52.99
 157856 64" universal bench rail set (4) \$79.99
 148166 (A) 3" locking caster set (4) \$59.99

D/S =
 Item drop ships
 direct from
 manufacturer.

Set up as a work bench
 surface, or rotate
 legs so ...



... second
 surface doubles
 as a scaffold



VIKA TWOFOLD™

Unfold the legs until the non skid polypropylene deck is on top and you have a scaffold 21.7" in height or continue rotating the legs around and extend and you have a workbench that is 47.6" long x 18.7" deep x 31.8" high with a tool tray, drilling hole, protractor and ruler inscribed into the MDF work surface. The

Twofold also comes with a built-in 3 outlet, 15 amp surge protected power strip and a 500-lb. capacity in either configuration. Plenty of strength and stability and at 48 lbs., light enough to be where you need it.

- 149184 \$149.99



Handle and mounting screws sold separately.

German Bench Screw Favored for its strength and versatility, this screw is used for end vises, cider presses, and bookbinder's presses. 32mm (1 1/4") dia. screw, length 480 mm (18 3/4") L, screw length 17". Collar and nut are made of malleable cast iron. Made in Germany.

- 01H41 \$79.99
 17E52 wood handle, 1" x 13 1/2" \$8.50

Workbenches

Sjöbergs of Sweden has manufactured top quality workbenches for over 90 years. Designed to meet the needs of the discerning woodworker, the range of features cannot be matched.



Elite Workbenches Constructed in European beech. The specially developed vises provide enormous clamping power across 23½". You will be amazed by the clamping speed, accuracy and smoothness. Bench adaptable for right- or left-handed persons! In less than two minutes, the front vise can be fitted on either side. A double row of 1" steel round dogs (4 included) work from both vises. The perfect foundation for your workshop.

- | | | | |
|--------------------------------|------------|--------------------------------|------------|
| 100111* Elite 2500 99¼"..... | \$2,215.00 | 146490* 2000 + Storage Cabinet | |
| 100110* Elite 2000 76½"..... | \$2,060.00 | SM-04, 354 lbs..... | \$2,575.00 |
| 153153* Elite 1500 59⅝"..... | \$2,000.00 | 153220* 1500 + Storage Cabinet | |
| 146480* 2500 + Storage Cabinet | | SM-03, 286 lbs..... | \$2,265.00 |
| SM-04, 390 lbs..... | \$2,730.00 | | |



Elite 2500 + Storage Cabinet SM-04 and Holdfast QSH, Weight 390 lbs



Elite Accessories

- | | | | |
|------------------------------------|----------|--|----------|
| 146496 (A) Holdfast QSH 1"..... | \$71.00 | 146473 Storage Cabinet Beech SM-03 | |
| 146477 (B) Steel Bench Dogs | | (Elite 1500, Duo, QR 1825)..... | \$665.00 |
| Round 1" (4 pcs)..... | \$108.00 | 154316 Storage Cabinet SM-08 | |
| 146491 (C) Aluminum Bench Dogs 1" | | (Elite 2500/2000)..... | \$555.00 |
| (4 pcs.)..... | \$104.00 | 154315 Storage Cabinet SM-07 | |
| 146474 Storage Cabinet Beech SM-04 | | (Elite 1500, Duo, Scandi 1425/1825)..... | \$445.00 |
| (Elite 2500/2000)..... | \$850.00 | 158466 Elite Jaw Cushions JC-12..... | \$27.00 |



SM-03 Beech Storage Cabinet, Fits Elite 1500, Duo, Scandi Plus Models



SM-07 Storage Cabinet In ¾" Ply, Fits Elite 1500, Duo, Scandi Plus



SM-08 Storage Cabinet ¾" Ply, Fits Elite 2500/2000

Sjöbergs Elite Accessory Kit – Elite Holdfast (146496), Universal Anvil UA-13 (159434) and the Elite Jaw Cushions JC-12 (158466).

160926 \$134.50

*Items that weigh more than 100 lbs. or are an unusual size, may be shipped by common carrier, and will be charged our actual discounted rates plus a minimal handling fee.
+Shown with optional storage cabinet SM-03

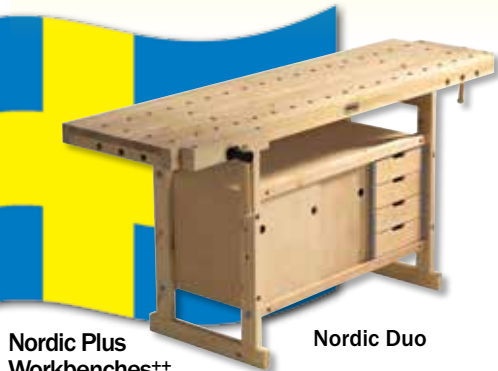
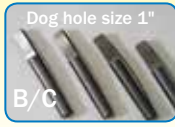
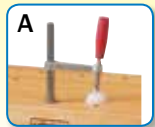

Nordic Plus Workbenches++

The size you need at a price you can afford. Bench top is constructed in hard Nordic birch. The amazing versatility of vice location permits left or right handed use, clamping on both ends, or dual clamping on the front. Supplied with four steel bench dogs with a plastic coating to protect your edge tools. Double row of clamping holes working from each of the four vise locations, giving an endless opportunity to clamp your work!

- | | |
|---|-------------|
| 146468 Nordic Plus 1450 Workbench 57⅞"..... | \$555.00 |
| 145267 Nordic Plus 00-42 Cabinet..... | \$199.00+++ |

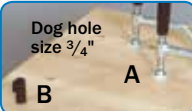

Accessories For Quick Release, Duo, Nordic Plus

- | | |
|--|---------|
| 146151 (A) Holdfast ¾", Pair..... | \$46.00 |
| 146476 (B) Bench Dogs ¾" (4 pcs.)..... | \$47.50 |

+Shown with optional storage cabinet SM-03
++ Shown with optional storage cabinet 00-42
+++ Fits all Nordic Plus models

Scandi Plus Workbenches

- Advanced Swedish design
- 100% European Beech
- Double row of round ¾" bench dogs working from both vises
- Includes 4 bench dogs with side springs that remain at the height required or drop flush into the dog hole

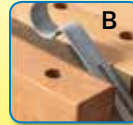

- | | |
|-------------------------------------|------------|
| 158460 Scandi Plus 1425, 53"..... | \$1020.00 |
| 158461 Scandi Plus 1425+ SM-03..... | \$1,500.00 |
| 158462 Scandi Plus 1825, 68"..... | \$1,180.00 |
| 158463 Scandi Plus 1825+ SM-03..... | \$1,650.00 |
| 158468 (A) Hold Fast ST-11..... | \$70.50 |
| 158467 (B) Jaw Cushions JC-11..... | \$16.25 |
| 159433 tool clamp, TC-11..... | \$63.50 |
| 159434 universal vise, UA-13..... | \$49.99 |



1825 Scandi Plus



1425 Scandi Plus

Duo Workbench+

Amazingly versatile. Four interchangeable vise locations and a double row of ¾" bench dog holes offer endless clamping options. Adaptable to either right- or left-handed use! Top and trestle are both crafted in oiled European beech. Four bench dogs included.



- | | |
|---|------------|
| 145896 Duo Bench 57¾"..... | \$699.00 |
| 146535 Duo + Storage Cabinet SM-03, 149 lbs. (shown)..... | \$1,225.00 |

Hobby Plus Workbench

- Hard Nordic Birch Top
 - Great for many projects
 - Double row of holes for the bench dogs
- | | |
|-------------------------------|----------|
| 158464 850, 33"..... | \$378.00 |
| 158465 1340, 53" (shown)..... | \$429.00 |



Sjöbergs Duo/Nordic/Hobby Plus, Junior/Senior Bench Accessory Kit

Include Holdfast ST-03 Single piece, Jaw Cushions JC-11 (158467), the Universal Anvil (159434) and a pair of Aluminum Jaw Protectors.

160927 \$97.00

Bench Model	Stock #	Height	Length of Worktop	Total Length Inc. Vise	Width of Worktop	Top Thickness		Vise Opening	Clamping Max. Distance		Bench Weight (lbs.)	Shipping Weight (lbs.)
						Center	Skirt		1-vise	2-vise		
Duo	145896	34"	53"	57¾"	21"	1⅞"	2¾"	4¼"	54½"	63"	89	95
Nordic 1450	146468	33½"	52¾"	57⅞"	19⅝"	1⅞"	2¾"	4½"	54¼"	62½"	66	72
Elite 1500*	153153	35½"	54⅞"	59⅝"	23⅝"	3⅝"	4¼"	5¾"	55½"	N/A	229	242
Elite 2000*	100110	35½"	71¼"	76½"	23⅝"	3⅝"	4¼"	5¾"	72"	N/A	268	286
Elite 2500*	100111	35½"	93¾"	99¼"	23⅝"	3⅝"	4¼"	5¾"	94½"	N/A	308	326
Scandi 1425*	158460	35½"	53"	57"	23"	1½"	4¼"	4½"	54½"	N/A	117	125
Scandi 1825*	158462	35½"	68"	73"	23"	1½"	4¼"	4½"	69¼"	N/A	138	145
Hobby 850	158464	32¼"	33¼"	38½"	19½"	1"	2¾"	4½"	35"	N/A	48	54
Hobby Plus 1340	158465	32¼"	53"	57⅞"	19½"	1"	2¾"	4½"	54"	N/A	70	76



Veritas® Wonder Dog & Wonder Pup

These versatile swivel handled clamps can be used anywhere you can drill a 3/4" hole, and they make easy work of clamping curved work and irregular shapes since any tip shape can be scrollsaw cut and quickly attached with 2 screws. The dog is drilled and tapped at a 3° angle. Comes in two sizes: the 6 1/2" Wonder Dog® or the 2 1/4" Wonder Pup®. Sold individually.

153368 (A) Veritas® Wonder Dog®..... \$37.50
153369 (B) Veritas® Wonder Pup®..... \$35.99



Veritas® Bench Hold-Down

The Veritas® hold-down clamp is designed to fit in any 3/4" drilled hole. Clamping force is controlled by the brass knob, and the arm is free to pivot in any direction, with clamping forces exerted downward into the clamped piece. The 10" hold-down post is canted during use, and the fine barbed grooves resist pulling out of the 3/4" hole, with 8" of clamping capacity in the vertical and horizontal direction. Made from high-strength zinc aluminum alloy, the hold-down features a machined steel post and a machined brass clamping knob. Sold individually.



153793 \$80.99

Traditional Bench Holdfasts

Large Bench Holdfast. The long reach and large holding pad of this holdfast allow you to quickly clamp or release everything from small boards to large carving blocks.



This method of clamping is perfect for projects that need frequent reorientation while planning, carving or working. Simply position the clamp in a 15/16" hole and give it a hard, solid hit with a mallet. To release, just hit the back side of the clamp. Heavy-duty ductile iron head featuring a 7 1/2" throat, 7/8" round steel shank with an overall length of 16 1/4".

Small Bench Holdfast. Similar to above but made from solid ductile iron with a 3 1/2" throat, an overall length of 8 1/4" and a 5/8" round shank.

Each 2+
145479 (A) large holdfast..... \$29.99..... \$26.99
145480 (B) small holdfast..... \$15.99..... \$14.39

Pinnacle® Bench Dogs

American made, Pinnacle® Brass Bench Dogs are manufactured to fit a 3/4"-diameter hole, and have a 2° negative slope, cross hatched face to ensure that your workpiece "stays put". A wire side spring provides friction necessary to keep the dog in place, while allowing for easy removal and placement in any 3/4" hole. The Pinnacle® Bench Dog measures 4 3/8" long. Sold in pairs.



151101 Pinnacle® Bench Dogs \$31.50



Veritas® Hand-Cut Dovetail Kit

Nothing says quality like furniture made with hand-cut dovetails. Nothing makes crafting them easier than the selection of Veritas items that we have put together. Dovetails require precise layout and precision cutting. Both can be accomplished with this kit. Kit includes a Veritas Fine-Cut Dovetail Saw (153371), Veritas 1:6, 1:8, and 1:4° Dovetail Saddle Markers (833750, 833751, and 153361) and the Veritas Dual Marking Gauge (153362).

153647 \$164.95



Veritas® Saws

The molded spine incorporates stainless-steel powder, glass fiber and an advanced polymer serves as the binder. An over-molded blade and stainless-steel handle-mounting bolt to create a solid one-piece blade/spine/mount assembly, and a single brass fastener secures the Bubinga handle.

Veritas® Carcass Saws are available in both 12 TPI ripcut and 14 TPI crosscut versions. The teeth of the saw are filed with alternating 15° bevels so wood fibers are severed, not torn, and have a relatively minimal set, at only 0.003" per side. The open-grip handle, made larger than those of classic carcass saws, permits a comfortable, secure grip. The high-carbon steel blade, 11" long and 0.02" thick, has a cut depth of about 2 3/8". Each saw is 16 3/8" long overall and weighs just under a pound.

153373 (A) carcass crosscut saw \$79.99
153374 carcass ripcut saw..... \$79.99

Veritas® Dovetail and Crosscut Saws are made of high-carbon steel, the blade of each is 9 1/4" long and 0.020" thick, with a cut depth of about 1 9/16". All three saws are 14 1/4" long.

153370 (B) standard dovetail, 14 TPI..... \$59.99
153371 fine dovetail, 20 TPI \$59.99
153372 small crosscut, 16 TPI..... \$59.99



Zona® Tools Deluxe Fine Kerf Razor Saw And Miter Set

The Zona® Tools Deluxe Fine Kerf Razor Saw and Miter Set excels at precise straight and miter cuts with wood inlay material, small moldings, pen blanks and more. The .01" thin blade, 24 TPI saw cuts through just about any type of material. The aluminum miter box holds material up to 2" wide and 7/8" thick for cuts at 90°, 45°, and 30°. Made in USA.

161791 set \$29.99
840085 saw only \$14.99

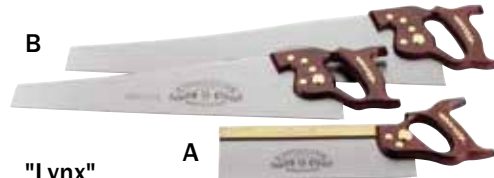

"Lynx" Handmade Saws

"Lynx" brand saws, are individually produced by a craftsman so you can be confident you will receive a reliable tool that will not fail under constant hard use. Setting and grinding of the teeth is done by hand so that proper tooth geometry is maintained for the best cutting action. Stained European beech handles are fitted to blades with solid brass mounting bolts.

(A) Lynx Backsaws. Strong, polished brass backs give these cabinet saws the extra rigidity for cutting perfectly straight tenons, dovetails, and other joints. Crosscut style teeth.

	Blade	TPI	Depth of Cut	Kerf	
147411	8"	20	2 1/4"	.048"	\$134.99
147410	12"	15	3"	.048"	\$109.99

(B) Lynx Handsaws. Taper ground blade provides friction-free cutting and the hollowing of the back reduces weight, improves balance, and lets the saw tip start a cut. Available in standard 26" length, and smaller 22" blade.

	Blade	TPI	Style	
147408	22"	10	crosscut	\$132.50
147406	26"	9	crosscut	\$149.99
147407	26"	4 1/2	rip	\$134.99

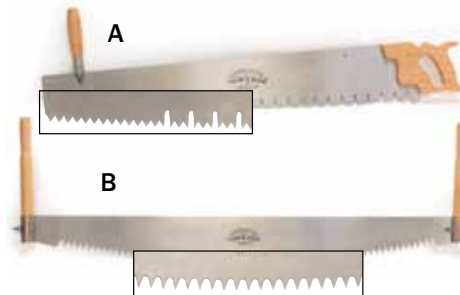

LYNX Crosscut Saws

These large saws are used mostly in forestry work and the crosscutting of large logs, but in recent years crosscut saws have been purchased for use in cutting personal firewood in a more traditional fashion. Each saw is made from British CS80 steel with a Rockwell hardness of 44-46 and a thickness of 1.5mm to provide the superior stiffness required when cutting on long strokes. Each tooth pattern is specifically designed for the size of the saw, is hand set, and can be sharpened with a large triangular file. One-man saw has three teeth and a gullet, while the two-man saw has 1 TPI Peg Tooth. Handles are solid beech.

154642 (A) 3' one-man \$174.99
154643 (B) 4' two-man \$169.99



Lynx Veneer Saw

This traditional veneer trimming saw is designed for clean, precise cutting. The no-set tooth design allows it to cut on both the push or pull stroke. Tearout is minimal to non-existent. The offset blade is designed to be used against a straight edge without handle interference. The 15 TPI curved blade also allows you to start a cut anywhere along your cut line. Overall length 8 1/2", blade is 3" in length, .020" thick with no set.

147415 \$26.99



Razorsaw Dozuki — Gyokucho

(Dozuki nokogiri) are among the finest cutting replaceable-blade saws made for cabinet and furniture work. The blade thickness is 0.012" and is set for a 0.016" kerf. The teeth are cut at 26 teeth/inch and are impulse hardened for extended wear. The blade is hard coated to reduce corrosion and increase durability.

Standard Blade 2⁵/₈" at widest point
Length is 9¹/₂", and overall length is 22¹/₂"

155669 No. 370 \$62.00

Replacement Blade

155676 No. S-370 \$40.00

Razorsaw Flush-Cut Saw — Gyokucho

(Kugihiki nokogiri)

Our Double Edge Flush-Cut Razorsaw has one edge of 32 cross-cut impulse hardened teeth per inch for hardwoods, and 21 crosscut impulse hardened teeth per inch on the other for softwoods. The thin and flexible (0.0012") blade is designed for very clean flush cuts as well as very fine cuts in narrow material. The riveted handle is made from Beech wood.



155681 Double Edge No. 1151..... \$26.50



Razorsaw Crosscut Saws — Gyokucho

(Kataba nokogiri) for hardwoods is designed for crosscuts in such woods as Oak, Teak, Maple and exotic hardwoods. The blade is 0.020" thick and has a fine tooth pattern of 22 impulse hardened teeth per inch for long wear.

Length: Blade 10"; Overall: 22"

155690 No. 105 \$40.00

Replacement Blade

155617 No. S-150..... \$24.00

Z-saw

6" Beading Saw

(Dozuki nokogiri)

An unique feature of this saw is the special "woodpecker" tooth at the end of the blade, which allows the user to start a cut in mid-panel. This is a great feature for doing cutouts and large mortises. The blade thickness is 0.012", and kerf is 0.018". The teeth are impulse hardened for extended wear. The handle is wrapped with rattan. The blade length is 6", overall length is 14¹/₂" with 21 teeth/inch. Blade can be easily replaced when dull or if damaged.

156736 150mm \$36.00

Replacement Blade

156741 150mm \$20.50

Screw Extractors

The easy way to remove sheared or broken screws! Using a drill press or a power drill with a pre-bored guide block, these hollow, sawtooth-edged extractors bore a clean hole around the broken screw without damaging the surrounding surface.



1/4" extractor removes up to a #8 screw, 5/16" up to a #10 screw, and 3/8" up to a #12 screw. Overall length 2", both ends are equipped with sawtooth cutting edges.

124210 1/4" \$10.99

124211 5/16" \$12.99

124212 3/8" \$13.99



Razorsaw Ryoba — Gyokucho

(Ryoba nokogiri) has a unique feature which allows the handle to be tilted in relation to the blade. This gives access into areas otherwise awkward or impossible to reach. Carpenters, restoration workers and boatbuilders will find this feature particularly useful. The teeth are impulse hardened for extended wear. The handles are wrapped with rattan for a secure grip. The various blades can be interchanged. Double Edge Saws (Ryoba Nokogiri) are the mainstay of the Japanese woodworker. One edge is used for ripping and the other for crosscutting. These saws are recommended for general purpose woodworking and cabinetmaking.

180mm Overall length: 15"; Crosscut teeth/inch: 19; Rip teeth/inch: 9.

155637 No. 291 \$37.99

155638 Repl. blade, No. S-291..... \$19.00

8 1/4" Overall length: 21"; Crosscut teeth/inch: 17; Rip teeth/inch: 8.

155689 No. 605..... \$39.00

155691 repl. blade No. S-605..... \$27.00

9 1/2" Overall length: 23"; Crosscut teeth/inch: 14; Rip teeth/inch: 7.

155608 No. 610 \$40.00

155618 repl. blade No. S-610 \$28.00

10 3/4" Overall length: 26"; Crosscut teeth/inch: 11; Rip teeth/inch: 6.

155675 No. 615..... \$45.00

155682 repl. blade No. S-615..... \$28.00

12" Overall length: 27¹/₂"; Crosscut teeth/inch: 9; Rip teeth/inch: 6.

155666 No. 616 \$53.00

155683 repl. blade No. S-616 \$35.50



Veritas® Double-Edged Flush-Cut Saw

Veritas® has developed a true flush-cut a 22 TPI blade with teeth set only to one side for a smooth finish and surface projection. This flexible saw provides an aggressive flush cut on the pull stroke and is rigid enough to provide exceptional control. The double-edged design allows for both left and right cutting, while the 4³/₄" blade length is the perfect size. Plug cutters not included.

153792 \$25.50

Veritas® Flush-Cutting Saws

Make clean flush cuts with Veritas Flush-Cutting Saws. Choose the longer, single-edge or shorter, double-edge design based on your unique cutting needs. Smaller size and dual blades of the double-edge saw let you cut in a variety of locations. Narrow and longer, the single-edge saw makes cutting in tight spots easier. Single edge saw has no set, while double edge saw has set only on the top side to prevent surface marring.

161271 single edge, 26 TPI (shown) \$24.99

153792 double edge, 22 TPI \$25.50



GRÖZ Deep Throat Fretsaw

This saw is an excellent choice for detailed marquetry and scrollwork where great depth is required. Uses 5", flat end, fret, scroll, jewelers or spiral saw blades. Depth of cut is 11¹/₂".

141407 \$29.99

Fretsaw Blade Assortment includes 36 blades in the skip-tooth pattern for general cutting in a variety of materials. Assortment includes one dozen each of #2 - 20 TPI, #5 - 12.5 TPI and #7 - 11.5 TPI.

141560 \$15.59

Specialty Marquetry Blades. These 5" blades are used for extremely intricate sawing in wood, plastic and hard rubber 1/16" to 1/4" thick. Both are approximately .023" wide, .008" thick, and have 33 TPI.

141408 3/0 skip-tooth (12) \$10.99

141409 3/0 double-tooth (10)..... \$9.50

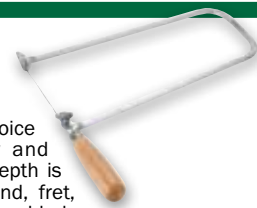

ECLIPSE

Coping Saw

Eclipse Saws are built with steel frames and wooden handles. The Coping Saw features a 360° blade rotation, a 14 TPI blade, a 4¹/₂" cutting depth, and an overall length of 12".

154762 \$17.99



Woodpeckers®

BladeSaver Adjustable

10" Saw Blade Guard

and Hanger

Woodpeckers® BladeSaver Saw Blade Guard and Hanger System protects your blades and you never need to touch the blade's sharp teeth. Simply lay the blade flat, wrap it around the teeth then latch the master link. BladeSaver Saw Blade Guard ensures that blade teeth can't contact or strike other blades or objects. Moulded of tough ABS plastic to provide years of protection. Saw Blade Guards are proudly made in the USA.

159561 \$12.99



Circular Saw Tooth Patterns



FTG - Flat Top Grind

Teeth with flat tops and faces separate wood fibers with a chipping action to lift out waste like tiny paddles. Designed for general ripping, they cut efficiently with the grain.

ATBR - Alternate Top Bevel with Raker

The addition of a raker tooth to an ATB blade transforms it into a combination blade capable of cross and rip-cuts.

ATB - Alternate Top Bevel

Flat-faced teeth with alternating top bevels sever wood fibers first on one side, then the other. Designed for general across-the-grain and un-defined grain cutoff and trimming.

Hi-ATB or HATB - High Alternate Top Bevel

The steep grind of these blades results in very smooth, splinter-free crosscuts. Lower hook angle requires slightly more feed pressure.

freud **Tico™ Hi-Density Carbide** specially formulated to reduce wear & last longer.

freud **Laser Cut Stabilizer Vents** **Anti-Vibration design.** stabilizes the blade to reduce chatter for a flawless finish and longer cutting life.

freud **Silver I.C.E.** resists corrosion, resin, or "pitch" build-up and heat, up to 2x longer than standard polished blades.

freud **Perma-SHIELD™ Coating** protects from rust & heat build-up.

freud **Premier Fusion General Purpose**

The best performing blades on the market. These flagship blades have a unique 30° Hi-ATB tooth with double-side grind geometry for a mirror smooth finish. (FREUD part #)
845842 10" D, P, TK, 40T, 18° (P410T) \$79.97
835866 10" D, P, FK, 40T, 18° ... (P410) \$99.97

Freud offers premium saw blades that are specially designed for your application.

All blades are carbide tipped unless noted.

D=Diam.; T=Teeth; °=Hook Angle; S=Silver Ice; P=Perma-SHIELD; TK=Thin Kerf; FK=Full Kerf; HD=Heavy Duty. 8½" and 10" blades have 5/8" arbors, 12" blades have 1" arbor.

Combination Blade

This "combo" blade gives you the ability to crosscut and rip with the same blade. This multi-purpose blade has a combo tooth design. 50T, 10°.

- 828761** 10" D, P, TK.....(LU83) \$59.97
- 127241** 10" D, P, FK.....(LU84) \$73.47

Glue Line Rip

Offered in both Thin & Full kerf, this blade provides smooth rip cuts that are ready for glue-up. Triple Chip tooth design for flawless finish. 12°.

- 842617** 10" D, 30T, P, TK(LM75) \$59.97
- 825271** 10" D, 30T, P, FK(LM74) \$69.97
- 834779** 12" D, 40T, P, FK D/S (LM74) \$87.47

Ripping Blade

Achieve smooth, fastrips in hardwoods & softwoods with these blades. Flat tooth design allows ripping in materials as thin as 1/8" and as thick as 3-1/2".

- 127243** 10" D, 24T, 20°, P, TK.....(LU87) \$43.47
- 825272** 10" D, 24T, 20°, P, FK(LM72) \$64.47

Ultimate Plywood & Melamine Blade

Best blade for cutting veneered plywood, melamine and laminates. The combination of the Hi-ATB tooth & anti-vibration slots make these blades great for sizing prefinished sheet goods, shelving, cabinets & doors. 2°.

- 833963** 10" D, 80T, TK, P.....(LU79) \$79.97
- 825270** 10" D, 80T, FK, P.....(LU80) \$94.47
- 835200** 12" D, 96T, TK, P... D/S (LU79) \$104.97
- 828753** 12" D, 96T, FK, P... D/S (LU80) \$137.47

Sliding Compound Miter Blade

These Industrial blades provide a superior finish cut with sliding compound miter saws. -5°, TK.

- 813737** 8.5" D, 48T, P..... D/S (LU91) \$63.97
- 821318** 10" D, 60T, S..... D/S (LU91) \$60.47
- 826707** 10" D, 60T, P..... D/S (LU91) \$71.47
- 832606** 12" D, 72T, P..... D/S (LU91) \$87.97
- 821319** 12" D, 72T, S..... D/S (LU91) \$78.47

Crosscut Blades

Freud's Crosscut blades vary in kerf, tooth count, and hook angle. Select less teeth for cutting thicker material and more teeth for finer finish.

- 147772*** 8" D, 64T, 10°, FK, P.... (LU85) \$79.99
- 127242*** 10" D, 80T, 10°, FK, P.. (LU85) \$89.97
- 821320*** 12" D, 96T, 10°, FK, P (LU85) \$129.97
- 127244** 10" D, 60T, 15°, TK, P (LU88) \$59.97
- 828763*** 12" D, 80T, 15°, TK, P.. (LU88) \$84.99
- 828762*** 10" D, 80T, 10°, TK, P... (LU74) \$71.47

Double Sided Laminate/Melamine

Designed to give long life & excellent finish on the top and bottom of laminates, melamine & veneered plywood. -3°, P.

- 825274** 10" D, 80T, FK, P.....(LU97) \$104.47

*D/S = Item drop ships direct from manufacturer.

6" & 8" Pro Dado Set
 Freud's stacked dado set has a 5 degree negative hook angle that will give you flat-bottom grooves and virtually splinter-free cuts. Includes two outer blades, three 2-wing chippers, shims, and carrying case. This makes it ideal for underpowered saws and comes with anti-kickback design. This set will produce grooves from 1/4" to 7/8" in 1/16" increments. 5/8" Arbor.
818830 6" D, 10T.....(SD206) \$86.47
127245 8" D, 12T.....(SD208) \$99.97

6" & 8" Super Dado
 Produces splinter-free, smooth, flat bottoms on everything from veneered plywoods and laminates to solid wood. This set was one of the first to have a 3/32" chipper which allows cut width to be adjusted in 1/32" increments, doubling the number of slot widths available. Includes 2 outside blades, six chippers, shims, carrying case, instructional poster & DVD. 5/8" Arbor.
813978 6" D, 20T..... D/S (SD506) \$183.47
127246 8" D, 24T.....(SD508) \$199.97

6" & 8" Dial-A-Width Dado
 The Dial-A-Width dado performs like a stacked dado except without shims. The exclusive Dial hub ensures accurate adjustments. Adjusts in .004" increments. Maximum 13/16" cut width. Works easily with right, or left-operating machines. Set includes 2 outside blades, 5 chippers, wrench, carrying case, instructional poster & DVD.
835310 6" D, 20T..... D/S (SD606) \$234.47
813642 8" D, 24T..... D/S (SD608) \$274.97

Box Joint Blade Set
 Box joint construction on the table saw is now easy. Unlike a dado set, shims and adjustments are not necessary to create perfectly square, flat-bottom box joints. By placing the two blades back to back, you get a 1/4" cut, and by placing them face-to-face, you get a 3/8" cut. Each set includes two 8" 20-Tooth blades, carrying case, and instruction for making box joints and a box joint jig. 5/8" Arbor.
831914 8" D, 20T..... (SBOX8) \$94.97



FORREST Premium Carbide Saw Blades



Sub-micrograin C4 carbide teeth on laser-cut plates that are hand-strengthened to a runout of ± .001 D=Diam.; T=Tooth; FK=Full Kerf; TK=Thin Kerf; UTK=Ultra Thin Kerf

10" 40T Ultra-Thin

.080 Kerf Woodworker II

- .045 less material than standard kerf
- .020 less material than thin kerf
- Ideal for expensive exotic or clear material
- Use on Table Saw only

154138 10" D, 40T, UTK D/S \$159.99



7 1/4" 70T Ply Veneer Worker

- Rip or Cross cut double-sided sheet goods without splintering or tear-out
- For Hand Circular Saws and Table Saws
- Flawless cuts without splintering, fuzz or chip-outs

154495 7 1/4" D, 70T D/S \$109.99



A Duraline Melamine And Plywood Blade

- Chip-free cuts on melamine and plywood
- 40° Points slice through thin bottom layers with no tears or chips
- Recommended for thin, low pressure, 2-sided laminates, plywood and fine crosscutting on all woods

943304 10" D, 80T, FK D/S \$179.99

B Dado King

- Each outside cutting blade has 24 teeth
- 4-wing type chippers
- Four 1/8" chippers, one 3/32" chipper, and one 1/16" chipper
- Various combinations, dadoses from 1/4" - 29/32"
- Magnetic shims and carrying case

943309 8" Dado \$319.99

C Woodworker II 10" 40T #1 Grind

- #1 Grind is a custom version of our top selling Woodworker II
- Produces a square flat-bottomed cut for box joints, splines, keyways, etc.

153696 10" D, 40T, TK D/S \$149.99

148387 10" D, 40T, FK \$149.99

D 10" 70T Ply Veneer Worker

- Superb splinter free crosscut and ripping of plywood (finished or unfinished) and hardwood laminate sheet goods
- 70 Teeth, 10° face hook for easier feed
- High alternate top level eliminates tearout on two sided veneer plywood
- Use on: table saws, panel saws, and radial arm saws

153357 10" D, 70T, TK D/S \$154.99

153358 10" D, 70T, FK D/S \$154.99

E Woodworker II 10" 20T Rip Blade

- Specifically designed to rip through heavy, thick stock
- No hesitation required when feeding

153660 10" D, 20T, TK \$94.99

148959 10" D, 20T, FK \$89.99

D/S = Item drop ships direct from manufacturer.

F Chopmaster Saw Blade

- General purpose blade for fine trim & cut-off work
- Every 5th tooth is a raker to clean out cut between points and reduce blade overload & flutter
- Use on: chop saws, sliding compound, mitre saws, and radial arm saws

814942 10" D, 80T \$149.99

811869 12" D, 80T \$159.99

Chopmaster Signature Saw Blade

- Every 3rd tooth is a raker plus a sheer face which produces a precision firm cut
- Excels on delicate prefinished crown molding, picture framing, finished composite molding

150266 10" D, 90T D/S \$179.99

150267 12" D, 90T \$189.99

Woodworker II

- 30T produces a planer rip finish on stock up to 3" thick material
- 40T "general purpose" for ripping and cross cutting up to 2" hard and soft woods
- 48T higher atb for ripping up to 1 1/2" stock and exceptional cross cutting for hard and soft wood
- Great for ripping & cross cutting finished plywood
- Thinner kerf minimizes resistance through wood for lower powered machines

Use on: table saws and saws with slide tables

151314 10" D, 48T, TK \$144.99

85N53 10" D, 30T, FK \$119.99

85N52 10" D, 40T, FK \$134.99

150268 10" D, 48T, FK \$144.99

FK = Full Kerf TK = Thin Kerf
UTK = Ultra Thin Kerf

Forrest Accessories

5" Blade Stiffener

- Dampens motor vibrations and reduces blade noise.
- For use with 10" saw blades.

943312 \$29.99



More Blades & Accessories!
See your local
Woodcraft Store
or visit woodcraft.com

TIMBER WOLF Bandsaw Blades

The world's only thin-kerf, low-tension, silicon steel bandsaw blades will outlast your old carbon steel blades by a mile! It has over 60% of the speed capabilities of a hook blade while giving you the great finish of a skip. The round design of the gullet eliminates any work hardening zones. Couple that with the special 6.5° rake, 5-tooth set pattern and .025" thick thin-kerf blade and you have an awesome bandsaw blade!



	Length	Width	TPI	Tooth	
144704	80"	1/4"	6	PC.....	\$28.99
140812	80"	1/4"	10	RK.....	\$28.50
140813	80"	1/2"	3	PC.....	\$31.50
144705	80"	1/2"	4	PC.....	\$27.99
144707	82"	1/4"	6	PC.....	\$27.99
140175	93 1/2"	1/8"	14	HP.....	\$33.99
144709	93 1/2"	3/16"	10	RK.....	\$33.50
140177	93 1/2"	1/4"	4	PC.....	\$30.50
144710	93 1/2"	1/4"	6	PC.....	\$30.50
140180	93 1/2"	1/4"	10	RK.....	\$30.50
835441	93 1/2"	3/8"	3	AS.....	\$31.99

	Length	Width	TPI	Tooth	
140183	93 1/2"	1/2"	3	PC.....	\$31.99
144711	93 1/2"	1/2"	4	PC.....	\$31.99
140187	93 1/2"	1/2"	10	RK.....	\$31.99
140189	93 1/2"	3/4"	3	AS-S.....	\$37.50
144712	105"	3/16"	10	RK.....	\$35.50
140178	105"	1/4"	4	PC.....	\$32.99
144713	105"	1/4"	6	PC.....	\$32.99
140181	105"	1/4"	10	RK.....	\$32.99
836683	105"	3/8"	3	AS.....	\$36.99
140184	105"	1/2"	3	PC.....	\$35.99
835443	105"	1/2"	3	AS.....	\$39.99
144714	105"	1/2"	4	PC.....	\$35.99
140188	105"	1/2"	10	RK.....	\$35.99
140190	105"	3/4"	3	AS-S.....	\$40.99
840618	105"	3/4"	2/3	VPC.....	\$44.99
835869	111"	1/4"	10	RK.....	\$34.99
153804	111"	1/4"	6	PC.....	\$34.99
843002	111"	3/8"	3	AS.....	\$40.99
835870	111"	3/8"	4	PC.....	\$38.99
835871	111"	1/2"	4	PC.....	\$37.99
153805	111"	1/2"	3	PC.....	\$37.99
835872	111"	3/4"	3	PC.....	\$48.99
840616	111"	3/4"	2/3	VPC.....	\$49.99
160956	115"	3/8"	3	AS.....	\$41.99
859672	115"	1/2"	3	PC.....	\$38.99

	Length	Width	TPI	Tooth	NEW!
160957	115"	3/4"	2/3	VPC.....	\$52.99
859673	115"	1/4"	6	PC.....	\$35.99
154525	125"	1/2"	3	PC.....	\$41.99
154493	125"	3/4"	3	AS-S.....	\$51.99
144716	133"	1/4"	6	PC.....	\$41.99
834014	133"	1/2"	3	PC.....	\$44.99
140191	133"	3/4"	3	AS-S.....	\$51.99
146533	137"	1/4"	6	PC.....	\$43.99
154492	137"	1/2"	3	PC.....	\$54.99
830598	137"	3/4"	3	AS-S.....	\$58.50
829911	142"	1/4"	6	PC.....	\$45.99
829910	142"	3/4"	3	AS-S.....	\$55.99
830096	142"	1"	3	PC.....	\$58.99
159245	153"	1/4"	6	PC.....	\$48.99
159246	153"	1/2"	4	PC.....	\$51.99
159247	153"	3/4"	3	AS-S.....	\$63.50
159248	153"	1"	3	PC.....	\$62.99

HP = High Performance
RK = Raker VPC = Variable Positive Claw
PC = Positive Claw AS-S = Alternate Set Special
AS = Alternate Set TPC = Thin Positive Claw



Starrett Duratec™ SFB Bandsaw Blades

The Starrett Duratec™ SFB Blade combines the best features of a flexback and hardback into a Super Band Saw Blade. Made from carbon steel with a flexible back. The blade is designed for contour and straight cutting. It is ideal for vertical and horizontal carpentry. The blade has many uses for wood, composites, plastics, mdf, and non ferrous metals.

Regular Tooth: Available in finer tooth pitches for smoother cuts in all woods. Not for resawing.

Hook Tooth: 10° rake angle – best for hard and difficult-to-cut woods. High rake angle makes the blade very aggressive.

Skip Tooth: 0° rake angle - best for softer woods. An all-purpose blade, excellent for resawing!

	Width	TPI	Tooth	
67½" Blades				
160400	1/8"	14	Regular	\$16.99
160401	1/4"	14	Regular	\$15.99
70½" Blades				
160402	1/8"	14	Regular	\$16.99
160403	1/4"	4	Skip	\$15.99
160404	1/2"	4	Hook	\$15.99
72" Blades				
160405	1/8"	14	Regular	\$16.99
160406	3/16"	10	Regular	\$15.99
160407	1/4"	10	Regular	\$15.99
160408	1/4"	4	Hook	\$15.99
160409	1/4"	4	Skip	\$15.99
160410	1/2"	4	Hook	\$15.99
160411	1/2"	4	Skip	\$15.99
80" Blades				
160412	1/8"	14	Regular	\$16.99
160413	3/16"	10	Regular	\$16.99
160414	1/4"	10	Regular	\$15.99
160415	1/4"	4	Skip	\$15.99
160416	1/4"	4	Hook	\$15.99
160417	1/2"	4	Skip	\$15.99
160418	1/2"	4	Hook	\$16.99
82" Blades				
160419	1/4"	10	Regular	\$15.99
160420	1/4"	4	Skip	\$15.99
160421	3/8"	4	Hook	\$16.99
160422	1/2"	4	Skip	\$16.99

	Width	TPI	Tooth	
93½" Blades				
160423	1/8"	14	Regular	\$19.99
160424	3/16"	4	Skip	\$18.99
160425	1/4"	10	Regular	\$17.99
160426	1/4"	4	Hook	\$17.99
160427	1/4"	4	Skip	\$17.99
160433	3/8"	3	Hook	\$18.50
160428	1/2"	4	Hook	\$18.50
160429	1/2"	4	Skip	\$18.50
160430	5/8"	3	Hook	\$19.99
160431	3/4"	4	Hook	\$21.99
160432	3/4"	4	Skip	\$21.99
99¾" Blades				
160434	1/4"	6	Skip	\$18.99
160436	3/8"	4	Skip	\$19.99
160435	5/8"	3	Hook	\$21.99
105" Blades				
160437	1/8"	14	Regular	\$20.99
160438	3/16"	4	Skip	\$20.99
160439	1/4"	10	Regular	\$18.50
160440	1/4"	4	Hook	\$18.50
160441	1/4"	4	Skip	\$18.50
160447	3/8"	3	Hook	\$18.99
160442	1/2"	4	Skip	\$19.50
160443	1/2"	4	Hook	\$19.50
160444	5/8"	3	Hook	\$21.99
160445	3/4"	4	Hook	\$24.99
160446	3/4"	4	Skip	\$24.99
111" Blades				
160448	3/16"	10	Regular	\$20.99
160449	1/4"	6	Skip	\$19.99
160453	3/8"	4	Skip	\$19.99
160454	3/8"	4	Hook	\$19.99
160450	1/2"	4	Hook	\$20.99
160451	5/8"	3	Hook	\$22.99
160452	3/4"	4	Hook	\$24.99

	Width	TPI	Tooth	
115" Blades				
160466	3/16"	10	Regular	\$15.99
160467	1/4"	6	Skip	\$15.99
160468	3/8"	4	Skip	\$16.99
160469	3/8"	4	Hook	\$16.99
160470	1/2"	4	Hook	\$16.99
160471	5/8"	3	Hook	\$24.99
160472	3/4"	4	Hook	\$24.99
123" Blades				
160455	1/4"	6	Regular	\$20.99
125" Blades				
160456	3/16"	10	Regular	\$21.99
160457	1/4"	6	Regular	\$20.99
160458	3/4"	3	Skip	\$25.99
133" Blades				
160459	1/4"	10	Regular	\$20.99
160460	1/4"	6	Regular	\$20.99
160461	1/2"	4	Hook	\$21.99
160462	3/4"	3	Skip	\$27.99
136½" Blades				
160463	3/4"	3	Hook	\$27.99
142" Blades				
160464	1/4"	10	Regular	\$21.99
160465	1/2"	4	Hook	\$21.99
153" Blades				
161240	1/2"	3	Hook	\$24.99
161241	5/8"	4	Skip	\$29.99
161242	3/4"	3	Skip	\$32.99



LAGUNA Resaw King Carbide Tipped Bandsaw Blades

If you're interested in maximizing the yield of expensive veneer grade woods and reducing the sanding necessary to create a finished surface while cutting through thick, heavy stock like a knife going through hot butter, this is the blade for you. Normal bandsaw blades use a hooked tooth design, with a set on each tooth that creates a larger kerf and leaves a rough cut. The Resaw King looks more like a table saw blade, with its C4 carbide tipped teeth that are individually brazed and ground to perfection on a stress crack resistant Swedish silicon steel back-

ing. Combine these one-of-a-kind features with the 3/4" to 1" width and the vibration/harmonic reducing 2-3 TPI variable pitch tooth design, and the result is a massive blade that will easily slice ultrasmooth, wafer thin veneers with minimal waste. All blades feature a .024" backing, 2-3 TPI with variable size width 12mm/14mm/16mm pitch to produce a .041" kerf.

849466	93½"	3/4"	\$149.99
849477	105"	3/4"	\$149.99
849489	111"	3/4"	\$149.99
848264	125"	1"	\$207.99

Saw Blade Lubricant

Use of a Saw Blade Lubricant prolongs blade life and produces smoother and quicker cuts. This wax stick is specially formulated to keep metal, plastic, and wood cutting blades from clogging because of chips or pitch. For use on all power and hand-held cutting tools including scroll, band, circular, hack, and jewelers saw blades. The lubricant stick measures 8" long x 1" in diameter. Keep a stick next to your band saw for resawing and another next to your scroll saw for stack cutting.



144624 \$9.99

WALL LENK Turbo Torch

Wall Lenk's little Auto Ignition Turbo Torch is great for shop tasks – from brazing bandsaw blades together to adding color to a project. The Torch is powered by the Piezo electronic ignition system with a safety locking mechanism, which complies with the new childproof safety laws. The windproof and waterproof ignition system makes it ideal for outdoor use as well.



154734 Turbo Torch \$12.99

Home Workshop Jigs & Fixtures From the Editors of Woodcraft Magazine

This hardworking book is aimed at helping you solve any number of project-building and shop-related problems. Featuring shop-proven plans to help make tablesaw, routers, drill press, bandsaw, lathe and other machines do more, plus ideas for making better surface work areas, sturdy supports such as sawhorses, and mobility aids. Instructions, illustrations and photographs are included with each project. 96-pages softbound.



160162 \$19.99



800 535-4482



Helping You Make Wood Work®



WoodRiver® Mortising Attachment

The WoodRiver® Mortiser is designed to be used on most stationary drill presses with quill diameters of 75mm (3"), 66.5mm (2.625"), 60mm (2.36"), 55mm (2.17"), 50.8mm (2"), 47mm (roughly 1.875"), and 40mm (1.57"). This attachment can be mounted, set up and ready to use within a few minutes. The fence bolts directly to drill press table and provides 4" under the hold-down bracket. The kit includes a cast-iron chisel holder with self-centering rod, fence, hold-down rods, four chisels and bits (1/4", 5/16", 3/8", 1/2"), and a convenient storage case.

159737\$129.99

Vise With Angle Adjustment

This handy drill press vise features precision ground dovetailed trunnions that ensure smooth operation and accurate adjustment to any angle from 0° to 90°. Solid cast-iron construction provides added stability. The base is designed to facilitate an endless combination of mounting options, perfect for those difficult drill press applications. Jaw opening measures 3 1/4".

143185\$52.50



WoodRiver® 22-Piece Tapered Drill Set

Give wood screws more bite by pre-boring with these tapered drill bits. This economical 22-piece set contains 7 drill bits with countersinks, stop collars, and an Allen wrench, all indexed in a wooden stand-up box. These bits let you drill perfect holes for #5 through #12 screws with a 3/8" countersink.

146145\$30.50



WoodRiver® Drill Bit Stop Collars

The 1/8" and 3/16" stop collars are a solid ring with socket head set screw to reduce marring of the material surface. The 1/4" and larger stop collars are of the "split-ring" design, which positively lock anywhere along the bit diameter. Includes: 1/8", 3/16", 1/4", 5/16", 3/8", 7/16", and 1/2" stop collars and hex key.

142562\$13.50



SNAPPY® 25-Piece Countersink Drill And Driver Bit Set

The SNAPPY Bit Set Includes Gold Screw Countersinks in: 5/64" x 3/8", 3/32" x 3/8", 7/64" x 3/8", 1/8" x 3/8", 9/64" x 1/2"; seven Drill Bit Adapters in: 1/16", 3/32", 1/8", 5/32", 3/16", 7/32", 1/4"; and six Driver Bits in: #1PH x 2", #2PH x 2", #3PH x 2", #1SQ x 2", #2SQ x 2", #3SQ x 2", and accessories in a rugged nylon pouch with carry handle, belt loop and small parts pocket.

830074\$79.99

SNAPPY® NEW! Countersinking 5-Piece Drill Set

In one step, you can drill, countersink, and counterbore the perfect sized hole for #4, #6, #8, #10, or #12 screws. Counterbores are 3/8" or 1/2" dia., ideal for plugs or dowel buttons. 1/4" hexshank can be used with power drills and quick-change chucks.

830846 5-pc. set\$34.99

830847 5/64" x 3/8"\$7.49

830848 3/32" x 3/8"\$7.49

830849 7/64" x 3/8"\$7.49

830850 1/8" x 3/8"\$7.49

830851 9/64" x 1/2"\$7.49

150719 trim head, 1/8" x 1/4"\$10.99

830854 3/8" stop collar\$4.19

161436 1/2" rotating stop collar\$24.99

830873 1/2" stop collar\$4.25

146734 5/64" repl. twist bit (2)\$4.25

146733 3/32" repl. twist bit (2)\$4.25

143732 7/64" repl. twist bit (2)\$4.25

146731 1/8" repl. twist bit (2)\$4.25

146730 9/64" repl. twist bit (2)\$4.25

SNAPPY® Roto-Stop Rotating Countersink Stop Collar

Rotating stop collar uses a low friction bearing in a large diameter ring to control the countersink depth of SNAPPY Twist Bit Countersinks. The inside of the rotating stop collar continues to spin with the countersink to prevent burning or marring the workpiece. Countersink bit is not included.

161436\$24.99



SNAPPY® Centrotec 1/4" Hex Quick Change Adapter

Use common 1/4" hex shank quick-change bits in drills with Centrotec chucks. The patented SNAPPY Quick Change Chuck accepts all tools with a 1/4" hex power bit shaft, allowing fast changes between drilling and driving. Simply pushing the bit in will lock it firmly into the drive channel with a hardened chrome ball bearing. Pulling back the knurled sleeve allows the tool to be quickly removed with just one hand.

161435\$24.99



FULLER Tapered Drills, Countersinks And Stop Collars

The combination of a quality high-speed tapered drill with a countersink and stop collar, in conjunction with the correct plug cutter, is by far the best way to prepare fine work for wood screws. Tapered drills afford greater gripping power for screws than standard twist drills because they match the tapers of their corresponding screw sizes, allowing the screw to grip along its entire length.



Our matching countersinks are made of high carbon steel and have four flutes for clean, accurate boring with minimum tear-out. They are adjustable along the length of the drill and can be tightened with two set screws. The stop collars are also adjustable for varying counterbore depths and can be set just behind the countersink cutters when a counterbore is not necessary.

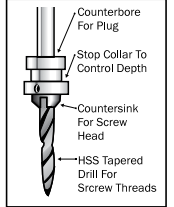

16-Piece Set. Includes 7 tapered drills from 1/8" to 7/32" by 64ths, corresponding countersinks, two stop collars and Allen wrench in a handy wood holder.

13D09 Save!\$93.49

12-Piece Set. Designed for cabinetmakers, this set has drills and countersinks for #5, #6, #7, #8 and #9 screws. Includes a 3/8" plug cutter, stop collar and Allen wrench, all in a foam lined case.

143662\$78.79

Tapered Drills also available individually.

	Diameter	Screw Size	
06J41	1/8"	5	\$6.99
06J42	3/64"	6	\$7.79
06J43	5/32"	7	\$7.79
06J44	11/64"	8	\$7.99
06J45	3/16"	9	\$9.29
06J46	13/64"	10	\$9.29
06J47	7/32"	12	\$9.29

Countersinks

06J31	3/8"	5	\$10.49
06J32	3/8"	6	\$10.49
06J33	3/8"	7	\$10.49
06J34	3/8"	8	\$10.49
06J35	3/8"	9	\$10.49
06J36	1/2"	10	\$10.49
06J37	1/2"	12	\$10.49

Stop Collars

06J51	3/8"	5-9	\$4.69
06J52	1/2"	10-12	\$5.29



FULLER Tapered Drills Boxed Set

Includes all the bits needed to install #6, #8, #10, #12, and #14 wood screws. You get 5 HSS tapered drills, 5 countersinks, 2 stop collars, 3/8" and 1/2" plug cutters, and 2 Allen wrenches. All in a finished hardwood case for protection and storage.

13D18\$119.99

FISCH Chrome Vanadium Steel Metric Brad Point Drill Bits

These are excellent drill bits for wood and wood composites. Chrome vanadium steel construction with ground center point prevents drill bit from walking across material surface. Superior designed flute improves chip extraction. Overall lengths range from 2½" to 6". Larger bits have reduced shanks to fit ⅜" drill chucks. Made in Austria.

Set of 8 Metric Brad Point Bits includes 3mm, 4mm, 5mm, 6mm, 7mm, 8mm, 9mm and 10mm sizes. **158409** set of 8 metric bits.....\$29.99

Individual Metric Brad Point Bits	
854350 3mm.....	\$2.99
854351 4mm.....	\$3.99
854352 5mm.....	\$3.99
854353 6mm.....	\$3.99
854354 7mm.....	\$3.99
854355 8mm.....	\$4.99
854356 9mm.....	\$4.99
854357 10mm.....	\$6.99
854358 11mm.....	\$6.99
854359 12mm.....	\$6.99
854360 13mm.....	\$6.99
158406 14mm.....	\$8.99
158407 15mm.....	\$8.99
158408 20mm.....	\$19.99

FISCH Chrome Vanadium Steel Fractional Brad Point Drill Bits

These are excellent drill bits for wood and wood composites. Chrome vanadium steel construction with ground center point prevents drill bit from walking across material surface. Superior designed flute improves chip extraction. Overall lengths range from 2½" to 6". Larger bits have reduced shanks to fit ⅜" drill chucks. Made in Austria.

Set of 7 Fractional Inch Brad Point Bits includes ⅛", ⅜", ½", ⅝", ¾", 7/16" and 1/2" sizes. **854348** set of 7 fractional bits.....\$29.99

Individual Fractional Inch Brad Point Bits	
854361 ⅛".....	\$4.75
158397 ⅜".....	\$3.99
854362 ½".....	\$4.50
158398 ⅝".....	\$3.99
854363 ¾".....	\$3.99
158399 7/16".....	\$4.49
854364 1/2".....	\$4.49
158400 11/32".....	\$4.99
854365 3/8".....	\$5.99
854366 7/16".....	\$7.50
854367 1/2".....	\$8.50
158401 9/16".....	\$8.99
158402 5/8".....	\$9.99
158403 3/4".....	\$19.99
158404 7/8".....	\$24.99
158405 1".....	\$29.99

MILESCRAFT® 7-Piece Fractional Brad-Point Drill Bit Set

The patented TwinLand® brad-point drill bit features a radical design that improves guidance and accuracy and provides accelerated chip clearance. Faster chip clearance means less heat, cleaner holes, and longer bit life. Alloy steel can be used with soft, hard, exotic, veneered and laminated wood. 7-piece set includes ⅛", ⅜", ½", ⅝", ¾", 7/16" and 1/2" sizes. Bits larger than ⅜" have reduced shanks to fit ⅜" drill chucks.

154242\$29.99



FISCH Extra Long 10" HSS Brad Point Bits

The extra length of these bits will come in handy when working on furniture, cabinetry, house projects, crafts or simple jigs. High-speed steel bits have large center points to keep them on track while boring deep holes. The superior designed flute improves chip extraction. Overall lengths are approximately 10". Larger bits have reduced shanks to fit ⅜" drill chucks. Made in Austria.

Diameter	Shank	
158410 1/4"	1/4" (shown).....	\$14.99
158411 5/16"	5/16".....	\$15.99
158412 3/8"	3/8".....	\$15.99
158413 7/16"	3/8".....	\$17.99
158414 1/2"	3/8".....	\$18.99
158415 9/16"	3/8".....	\$22.99
158416 5/8"	1/2".....	\$29.99

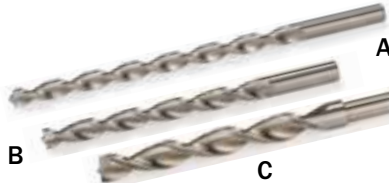

FISCH Pen Maker's Bits

What sets the Fisch Pen Maker's Bits apart from conventional style drill bits is the deep fluted shape that allows for rapid removal of chips, less clogging with a dramatic reduction in boring friction and heat buildup. This flute guides the bit straight through tough end grain and guarantees clean entrance and exit holes. Fisch bits are made from high quality M2 high-speed steel that has been hardened to 64 HRC that allows these bits to drill up to 1,350 holes without sharpening, depending on the density of the wood. Isn't it time to arm your pen turning arsenal with the best?

154741 (A) 7mm.....	\$11.99
154742 10mm.....	\$19.99
154743 3/8".....	\$17.99
154744 (B) 25/64".....	\$21.99
154745 27/64".....	\$24.99
154746 15/32".....	\$29.99
154747 31/64".....	\$30.99
154748 (C) 33/64".....	\$31.99
154749 letter "O".....	\$14.99

WoodRiver® Brad Point Drill Bit Index Sets

High carbon steel brad point drill bits in all the sizes that you need presented in a durable, indexed storage case. Each set features a case molded of high-impact resin with automatic indexing for easy bit access and quick identification. All bits have full diameter shanks with true brad points on ⅛" (3mm) diameter sizes and larger. 29-piece fractional inch brad point set sizes include: 1/16" to 1/2" in 1/64" increments. 25-piece metric brad point set sizes include: 1mm to 13mm in 0.5mm increments.

151040 29-pc. fractional inch.....\$39.99

151041 25-pc. metric.....\$41.50

WoodRiver® 100-Piece Drill Bit Set

includes six to ten each of 14 sizes ranging from 1/16" to 5/16". A metal storage case with an insert to organize bits by size is included.

158296\$49.99

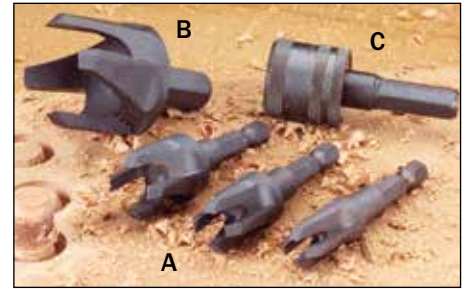

SNAPPY® Tapered Plug Cutters

These hex drive plug cutters maximize the torque needed to bore into the hardest woods. Plug cutter set is made of hardened steel for long tool life. Features tapered sides and a chamfered end for easy starting, tight fitting plugs. Set of three cutters for ¼", ⅜", and ½" plugs.

146723 (A) set of 3, ¼", ⅜", & ½" \$33.99

146724 ¼" plug cutter.....\$11.59

147654 5/16" plug cutter.....\$12.25

830818 3/8" plug cutter.....\$16.25

147655 7/16" plug cutter.....\$13.69

830819 1/2" plug cutter.....\$17.50

146725 5/8" plug cutter.....\$20.39

146726 3/4" plug cutter.....\$27.29

147656 (B) 1" plug cutter.....\$30.99

830806 (C) quick change chuck.....\$10.49

161435 Centrotec ¼" hex QC adapter..\$24.99



Drill Guide Sets

Drill perpendicular holes on flat surfaces, board edges, cylinders, even spheres! Set includes 3/16", ¼", 5/16", 3/8", 7/16" and 1/2" diameter hardened steel bushings. Also includes a center punch/locator pin.

140876 std. fractional-inch guide.....\$17.99

Metric Guide Set

Metric guide set includes 4mm, 5mm, 6mm, 8mm, 10mm, 12mm guides.

158758 metric guide.....\$16.79

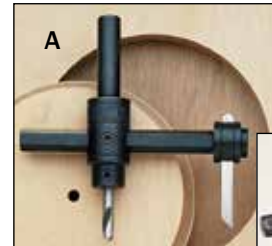

Circle Cutters

Designed for use in drill presses for cutting clean holes from 1" to 7/8" in diameter up to 1" deep. High speed steel single wing cutters are easy to sharpen and set up. Center pilot bits keep the tools on center for exact results. Max. speed 500 RPM.

(A) Large Circle Cutter for 1¾" to 7/8" diameter circles. Has ¼" pilot bit and 1/2" diameter shank.

16N41\$36.79

16N45 extra wing cutter.....\$10.49

(B) Small Circle Cutter for 1"-6" diameter circles. Has 6mm pilot bit and stepped 3/8"-1/2" diameter shank.

145072\$38.50

145230 extra wing cutter.....\$11.50





Plug And Tenon Cutter Sets

High quality carbon steel cutters feature 4 or 5 (depending on size) cutting spurs to quickly remove stock. Make tenons or plugs up to 3" long. Use for joinery, chair spindles, toy making, anywhere you need to create a quick, accurate tenon. 3-piece set features 3/8", 1/2" and 5/8" cutters, 5-piece set also includes 3/4" and 1" cutters. Both sets are packed in a wooden storage box.

- 141009 3-piece set..... \$44.99
- 141010 5-piece set\$69.50



WoodRiver®

8-Piece Deluxe Plug Cutting Kit

This kit will satisfy most all of your needs for wooden plugs. Includes a straight and a tapered plug cutter in 1/4", 3/8", 1/2", and 5/8" diameters. These quality carbon steel cutters feature fast cutting edges to make smooth sided plugs with rounded shoulders. The straight cutters are self-ejecting. All 8-pieces are fitted and labeled in a handy wooden storage case.

- 143567 \$51.99

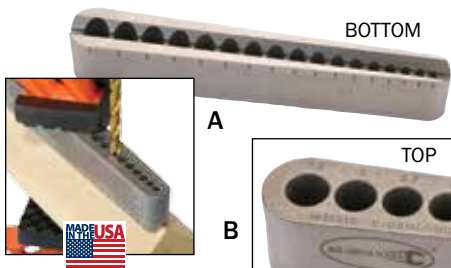

BIG GATOR TOOLS DrillGuide™ Portable Drilling Guides

The BIG GATOR TOOLS V-DrillGuide™ is like a portable drill press for precision alignment! V-groove along the bottom of the guide allows for perpendicular alignment with all drill sizes on round parts and corners. Bottom surface is precision ground to assure stability and accurate perpendicular alignment on flat surfaces. Standard DrillGuide is sized for fractional drill bit sizes of 1/8" to 3/8" in 1/64" increments. Metric DrillGuide is sized for metric drill bit sizes of 3mm to 9.5mm in 0.5mm increments plus 3.3mm, 4.2mm and 6.8mm. Guides are made from special nickel alloyed steel that is heat treated for durability. Drill straight - every time!

- 154758 (A) standard DrillGuide.....\$24.99
- 154759 (B) metric DrillGuide\$24.99
- 158980 9-hole 3/8" to 1/2" (not shown)....\$29.99

Titanium-Nitride Coated Countersinks



These industrial duty countersinks will last 4 times longer than high-speed steel models. Super-hard bonded titanium-nitride surface cutssmoother and faster with less pressure than conventional countersinks. For use in

any machinable material—steel, iron, soft metals, plastic and especially wood. Available in three sizes to cover all countersinking applications. 1/4" shanks, 5 flutes with 82° included angle.

- 147209 3/8" diameter.....\$8.99
- 04N46 1/2" diameter*.....\$14.69
- 04N56 3/4" diameter*.....\$17.39
- 04N40* set of 2 Save!.....\$28.89
- 147470 set of all 3 above Save!.....\$31.49



Self-Centering Hinge Drilling VIX Bits

These highly accurate bits are used for precise drilling of holes for cabinet and door hinges, door butts and all large and small hardware. Desired depth is achieved by loosening a setscrew, setting the high speed drill bit, then tightening the setscrew.

- 16143 5/64" bit for #3 & 4 screws\$14.50
- 16141 7/64" bit for #5 & 6 screws.....\$12.99
- 16142 9/64" bit for #8, 9, 10 screws.....\$13.99
- 16140 set of 3 above Save!.....\$29.99
- 16146 5/64" repl. bit.....\$3.19
- 16147 7/64" repl. bit.....\$3.19
- 16148 9/64" repl. bit.....\$3.19

Woodpeckers® Shelf Pin Drilling Template



Woodpeckers Combo Shelf Pin Template combines holes of both inch and metric spacing to work with self-centering drills bits, router guide bushings and even plain drill bits using the optional drill guide. CNC machined from 3/8" thick phenolic sheet with twenty-one holes on 1" spacing. Choose 1 1/2", 2" or 2 1/2" offset from edge on one side and fifteen holes on 32mm spacing with euro standard 37mm offset from edge on the other side. 3/8" diameter holes are compatible with most self-centering shelf pin bits and 3/8" OD router guide bushings for plunge boring. Includes three each 1/4" and 5mm Index Pins for setting offset and for continuous boring of long panels.

- 151136 combo shelf pin template\$69.99
- 830812 1/4" SnapPy bit.....\$28.50
- 148011 5mm SnapPy bit.....\$28.39
- 148156 3/8" OD Whiteside guide bushing\$18.99
- 03K33 1/4" Whiteside up-cut bit\$20.99
- 148048 5mm Whiteside up-cut bit.....\$22.49

SNAPPY®

Quick-Change Hinge Bits

These 1/4" hex drive bits and accessories let you quickly and easily change from one bit to the next. Spring-loaded, self-centering hinge bits for #2 through #10 screws, will perfectly align your screw holes with the holes in your hinges, drawer slides or other similar hardware. The 1/4" and 5mm bits are designed for use with shelf pin drilling jigs. USA.

- 830809 hinge bit, 5/64" (#2 - #4 screws) \$10.49
- 830810 hinge bit, 7/64" (#6 screws).....\$12.39
- 830811 hinge bit, 9/64" (#8 - #10 screws)\$12.59
- 834405 hinge bit, 5mm centering.....\$34.99
- Euro screws\$31.99
- 146721 set of 3 (5/64", 7/64", 9/64").....\$31.99
- 146727 5/64" replacement bit.....\$3.25
- 146728 7/64" replacement bit.....\$3.25
- 146729 9/64" replacement bit.....\$3.25
- 830812 shelf pin bit, 1/4"\$28.50
- 148011 shelf pin bit, 5mm\$28.99
- 148012 5mm replacement bit\$10.49



MILESCRAFT®

DrillBlock™ Drilling Guide

This cleverly designed tool features metal insert guides held at tight tolerances in a resin frame to allow you to drill a hole 90° to any surface. Six common drill diameters of 1/8", 3/16", 1/4", 5/16", 3/8" and 1/2" combine with V-grooves on the bottom to align the guide for drilling square corners and dowel surfaces. Metric 6-hole has 4mm to 12mm guides. Each guide is marked with centerlines to ensure accurate alignment when drilling into various surfaces and nonslip grips inserted in the top and bottom surface hold the DrillBlock in place. Ergonomic design comfortably fits hands of all sizes with ease.

- 158941\$7.99
- 159466 metric.....\$9.99



WoodRiver® Shelf Pin Jigs

Drill shelf pin holes for adjustable shelving in cabinets, bookshelves or AV furniture. The jig's 3/8" guide holes align most self-centering boring bits. Standard jig has 1" spacing and can be offset either 1 1/2" or 2 1/2" from edge. Metric jig has 32mm spacing and can be offset either 37mm or 50mm from edge. Includes special pin to index the jig for longer length projects. The 1/4" and 5mm shelf pin bits, sold separately, produce crisp holes with little tear-out and can be used with either jig.

- 150720 13-hole metric pin jig (shown) ...\$20.99
- 150721 15-hole standard shelf pin jig...\$20.99
- 150722 (A) 1/4" drill bit & guide.....\$17.89
- 153218 1/4" replacement bit, 2-pc.\$9.49
- 150723 (B) 5mm drill bit & guide.....\$17.89
- 153219 5mm replacement bit, 2-pc.\$9.49

MILESCRAFT®

Doweling Tools

The JointPro™ Deluxe Doweling Jig uses interchangeable metal guide bushing blocks and two self-clamping fixtures for perfect alignment of corner, surface or edge joints. The JointCrafter™ Doweling Jig uses integral metal guide bushings for drilling holes and is self-centering on boards up to 2½" wide, with molded pins and fence guide for accurate placement of holes. JointPro guide blocks contain three of each size, while the JointCrafter contains one each of the ¼", 5/16", and 3/8" metal drill guides. Drill bits, drill stops and dowel pins are not included with JointPro or JointCrafter. Each DowelKit includes TiN coated brad-point bit, drill stop, two corresponding dove hole centers and sample hardwood fluted dowel pins with chamfered ends. Eight-piece Dowel Tenon Center Set contains two each of the ¼", 5/16", 3/8" and ½" dowel centers. These dowel centers allow you to align dowel holes in drilled parts to accurately mark drill location in mating material. Next larger size dowel centers slip over dowel pins and round tenons to precisely mark location for dowel holes for proper assembly.

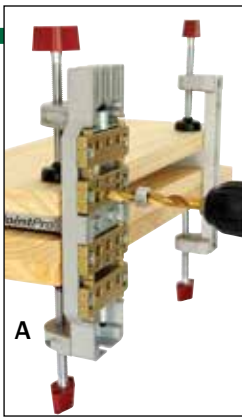

158281 (A) JointPro.....	\$58.75
153548 JointCrafter.....	\$18.50
153549 ¼" DowelKit.....	\$5.25
153550 5/16" DowelKit.....	\$5.59
153551 3/8" DowelKit.....	\$6.25
153552 8-pc. dowel center set.....	\$4.25



Dowel And Tenon Centers

Zinc-plated steel centers perform three basic alignments. For dowelling, the centers will make correctly positioned marks for precise drilling of your second set of holes. To properly position chair rungs or other spindle work, slip a center over the end of your tenon to mark the location for boring. To find the center of a dowel, slip a center over the end and tap lightly.

123717 ¼", bag of 10.....	\$6.99
123718 5/16", bag of 10.....	\$7.25
123719 3/8", bag of 10.....	\$7.99
123720 ½", bag of 10.....	\$8.99

DOWELMAX Precision Engineered Wood Joinery System

Create strong, accurate wood joints of virtually any configuration and size. Dowelmax joint configurations and sizes can be single, double and triple row, flush, offset, mitered, and face joints, from 1" x 1" to 1" x 12" and from 2" x 2" to 4" x 12". The patented design, coupled with rigorously maintained manufacturing tolerances of the numerous aluminum, brass and steel components, ensures that the Dowelmax is accurate and repeatable from workpiece to workpiece. The Dowelmax Kit is a professional quality, precision engineered joining system that is intended to last a lifetime. The main body of the jig is polished 6160 aluminum and the drill guide material is carbo-nitride hardened and black oxide coated steel. All Dowelmax components are manufactured and assembled in North America.

412425 Dowelmax joinery system \$249.99

412428 repl. 3/8" drill bit & collar \$17.39

412426 ¼" drill guide set..... \$81.99

412427 1/8" spacer plate..... \$13.19



Dowel Pins

Spiral glue channels to eliminate air pockets and assure good glue distribution. Chamfered ends for easy insertion.

	Dia.	Length	Qty.	
161879	¼"	1½"	15	\$1.99
161880	¼"	1½"	100	\$4.99
161881	5/16"	1¾"	15	\$1.99
161882	5/16"	1¾"	100	\$4.99
161883	3/8"	2"	15	\$1.99
161884	3/8"	2"	100	\$5.99

Our 120-piece assortment of spiral-groove dowel pins includes - (50) ¼" x 1½"; (20) 3/8" x 2"; (50) 3/8" x 1½".

158146 120-pcs. \$11.99



FAMAG BORMAX Forstner Style Bits

A radical new design that features razor-sharp, wave-form cutting teeth that work cooler, require less power with less friction. This



results in more efficient cutting with an improved finish from a bit that can stay sharp longer than any forstner bit on the market. Side clearance on the bit provides tear free and accurate holes in both soft and hardwoods. Overall length for all bits is 3½". Shank size is 5/16" on bits 5/8" - 13/16" and 3/8" on bits 1¼" - 2¼". Set of 5 contains 5/8", 3/4", 1", 1½" & 1¾" in a wooden box. Set of 13 (no box) contains 5/8" - 2½" in 1/8" increments. Made in Germany.

140014 *boxed set of 5 Save!	\$139.99
143235 set of 13 Save!	\$459.99
129987* 5/8".....	\$20.99
129988 11/16".....	\$26.29
129989* 3/4".....	\$27.29
129990 13/16".....	\$29.39
129991 7/8".....	\$29.39
129992 15/16".....	\$29.39
129993* 1".....	\$31.49
129994 1¼".....	\$31.49
129995* 1½".....	\$31.49
129996 1¾".....	\$35.69
129997 1¾".....	\$35.69
129998* 1¾".....	\$41.99
129999 35mm.....	\$41.99
140010 1½".....	\$47.29
142161 40mm.....	\$62.99
143219 1½".....	\$49.39
140011 1¾".....	\$51.49
143221 1¾".....	\$53.59
140013 2".....	\$54.89
143220 2½".....	\$70.39
140012 2¼".....	\$78.79

FAMAG Standard Forstner Style Bits

Smaller sizes available without the wave-form cutting edge.

12E31 ¼".....	\$12.59
12E32 3/8".....	\$13.69
12E33 ½".....	\$13.69

Forstner Bit Extensions. These extend depth capacity and are made of high quality, precision machined steel, with reduced shanks that let you use them in any 3/8" drill. Each uses a hex screw to hold the bit thin shank in the extension.

144512 5/16" x 5" extension.....	\$23.09
144513 5/16" x 9¾" extension.....	\$30.49
144514 3/8" x 5½" extension.....	\$30.49
144515 3/8" x 9¾" extension.....	\$37.79

www.woodcraft.com



Self-Centering Doweling Jigs

Guaranteed Accuracy And Alignment!

The patented automatic self-centering action of these jigs assures accurate center drilling every time, even on round objects. Large steel clamping screw tightens the tool like a vise, with rugged aluminum sides holding work securely without damage to the wood. Large 2" to 27/16" capacity on all models will handle most size requirements. Drill guide centers are hardened, guide holes are precision drilled and reamed for extreme accuracy.

(A) Economy Doweling Jig has five permanent drill hole sizes: ¼", 5/16", 3/8", 7/16", and ½".

811564 \$54.59



Wide Capacity Economy Jig. Similar to above, but with a capacity of up to 6" wide. Perfect for face work on 2x4 & 2x6 stock, even works with 4x4's & 6x6's.

821330 \$68.99

(B) Deluxe Doweling Jig features two permanent drill hole sizes: 7/16" and ½" and six removable screw-in bushings for extra hole patterns. Bushing sizes are ¼", 5/16", 3/8" (two of each). Allows drilling of two holes of the same size parallel to one another for double dowel applications on a 3/4" center to center space.

811565 \$64.99

Premium Doweling Jig (not pictured) is similar to the Deluxe model above, except all four holes are tapped for bushing use. Includes ¼", 5/16" and 3/8" bushings (two of each).

124315 \$66.50

Additional Bushing Set for the Deluxe and Premium models include one each of the ¼", 5/16" and 3/8" bushings.

811615 \$10.49

Woodboring

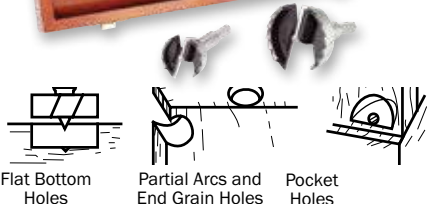

WoodRiver® Forstner Bit Sets

16-Piece Set. We've seen many imported forstner bit sets here at Woodcraft, and quite frankly we were very skeptical when we began to test these. To our surprise, these bits looked good, cut clean, and did not burn even though we intentionally tried to "hurt" them with quick, repetitive drill press borings. We believe these are an exceptional value for the hobbyist or occasional user. Bits larger than 1" have "saw toothed" edges to keep the larger cutting edge cool while boring. Includes 1/4" - 2 3/8" in 1/8" increments, packed in a wooden case. 3/8" SH, 3 1/2" overall length.

147067 set of 16 Save! \$97.99

7-Piece Set. Includes 1/4" - 1" bits in 1/8" increments with 3/8" shanks in a wooden storage case.

147068 set of 7 Save! \$32.50

10-Piece Set. Includes 1/4" - 1 1/2" bits (no 1 1/8") in 1/8" increments with 3/8" shanks in a wooden storage case.

147069 set of 10 Save! \$50.99

24-Piece Set. Our most complete set - includes: 1/4" - 3 1/8" bits in 1/8" increments. Bits less than 2 1/8" in diameter are 3 1/2" long with 3/8" shanks; bits 2 1/4" diameter and larger are 6" long with 1/2" shanks.

145501 set of 24 Save! \$209.99

Forstner Bit Extensions add 4" or 10" of extra length to your bits. Attaches to your bit with two set screws.

145705 3/8" shank x 4" extension.....\$8.50

145706 1/2" shank x 4" extension.....\$8.50

147999 3/8" shank x 10" extension.....\$13.99

148000 1/2" shank x 10" extension.....\$21.50

Individual Forstner Bits

Bits 2 1/8" or smaller have 3/8" shanks; bits larger than 2 1/8" have 1/2" shanks.

125923 1/4".....\$4.75 | **125938 1 3/8" ..\$10.50**

125924 5/16".....\$4.99 | **125939 1 1/2" ..\$10.99**

125925 3/8".....\$4.99 | **125940 1 5/8" \$12.50**

125926 7/16".....\$5.29 | **147998 40mm\$12.50**

125927 1/2".....\$5.29 | **128143 1 9/16" \$12.99**

125928 9/16".....\$5.50 | **125941 1 3/4" ..\$11.99**

125929 5/8".....\$7.99 | **125942 1 7/8" ..\$14.50**

125930 1 1/16".....\$7.25 | **140866 1 15/16" \$14.50**

125931 3/4".....\$7.50 | **125943 2".....\$12.99**

151279 18mm..\$8.50 | **125944 2 1/8" ..\$16.99**

151281 20mm..\$8.50 | **125945 2 1/4" ..\$18.99**

125932 13/16"\$7.89 | **125946 2 3/8" ..\$19.99**

125933 7/8".....\$8.25 | **125947 2 1/2" ..\$20.25**

125934 1 5/16".....\$8.25 | **125948 2 5/8" ..\$20.99**

151282 25mm..\$7.99 | **125949 2 3/4" ..\$24.50**

125935 1".....\$8.39 | **125950 2 7/8" ..\$24.99**

147884 1 1/16" ..\$9.50 | **125951 3".....\$24.75**

125936 1 1/8".....\$8.99 | **125952 3 1/8" ..\$30.75**

147997 30mm \$9.99 | **125953 3 1/4" ..\$32.50**

125937 1 1/4"\$9.99 | **125954 3 1/2" ..\$35.50**

142511 35mm carbide tipped.....\$28.99

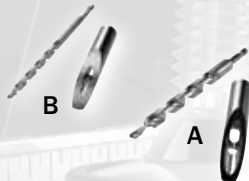

KREG® DB210 Foreman Electric Pocket-Hole Machine

The professional-grade DB210 Foreman Electric Pocket-Hole Machine makes it possible for woodworkers, cabinet shops, contractors, and dedicated do-it-yourselfers to complete projects using Kreg pocket-hole joinery with twice the speed and half the effort of a standard pocket-hole jig. You will be amazed at how quickly and easily you can drill perfect pocket holes time and time again. Whether you are a professional cabinetmaker or a weekend do-it-yourselfer you will immediately appreciate the great features the DB210 Foreman Electric Pocket-Hole Machine has to offer. With one pull of the handle, the motor starts, the workpiece is clamped, and the machine drills perfect pocket holes. The adjustable fence positions the workpiece for precise pocket depth in 1/2"- to 1 1/2"-thick material, and a pair of adjustable stops provides repeatable accuracy. A powerful 110-Volt, 5.0-Amp, 2,800-RPM motor enables fast drilling, and a quick-change chuck

allows for fast bit changes. Plus, the new Foreman is the first Kreg pocket-hole machine that can create all three types of Kreg joints: standard 3/8", smaller Micro Pocket™ and 50% stronger HD joints. The Foreman comes with a 3/8" step-drill bit and hardened guide bushing, while the accessory Micro Pocket™ and HD drill bits and guide bushings are sold separately. The machine features a sturdy polypropylene base with a large 14" x 23 1/2" cast aluminum tabletop to provide ample work space. There is even a built-in storage tray for accessories and a dust-collection port on the base that is connected internally to catch chips at their source.

861426 DB210 Electric Foreman..... **\$399.99**

159463 (A) HD drill bit and bushing **\$31.99**

159464 (B) Micro drill bit and bushing.....**\$26.99**

159465 repl. HD drill bit **\$19.99**

148991 repl. 3/8" drill bit..... **\$17.99**

149965 repl. Micro drill bit..... **\$16.99**

Kreg Jig® R3

If you're ready to start your next woodworking project or home improvement project, the R3 Kreg Jig® is the tool for you. Kit includes R3 Kreg Jig® Clamp Pad Adapter, drill bit, depth collar, and Allen wrench all contained in a durable plastic carrying case with built-in depth collar setting gauge and screw selection chart.

147643 **\$39.99**

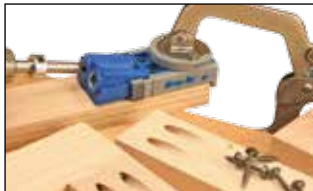

KREG® 90° Corner Clamp

Kreg combines the function of a corner clamp with the convenience of a face frame clamp to create the ultimate clamp for box construction. Self-squaring design pulls drawer boxes into alignment, quickly and easily. Shelving assembly is a snap with 90° corners and T-joints. Large clamping surface protects soft woods against workpiece imprint. Includes quick-adjust handle for varying stock thicknesses up to 1 1/4".



Each **\$36.99** 4+ **\$33.29**

149090 **\$36.99** **\$33.29**

KREG® Face Clamps

The 2" Classic Face Clamp has a 2" reach, and the 3" Face Clamp has a 3 1/4" reach for face members 2" and smaller.

161720 2" Classic face clamp..... **\$14.99**

149086 3" Classic face clamp..... **\$22.99**



KREG® Automaxx® Wood Project Clamps

Adjust automatically to material thicknesses. The 3" reach for face members 2" and narrower automatically adjusts to any material thickness up to 2 7/8", while the 6" reach for face members 2" and wider automatically adjusts to any material thickness up to 4 1/4".

NEW!

162021 3" Automaxx project clamp **\$29.99**

162022 6" Automaxx project clamp **\$37.99**

KREG® Automaxx® Right Angle Clamp

Truly the "secret weapon" for pocket-hole construction, the Automaxx Technology makes projects with 90° joints faster and easier to drive in the screws. Just slip the pin on the Right Angle Clamp into a pocket hole, close the clamp. The swiveling clamp pad opposite the pin grabs the mating piece securely. The Automaxx auto-adjust technology adjusts to match the material automatically with a simple squeeze of the handles. With its 3 1/2" reach it clamps materials up to 3 3/8" thick.

162023 **NEW! \$34.99**



KREG® System Organizer

The KREG System Organizer holds your K5, K4 or K3 Kreg Jig® plus your accessory clamps, bits, drill guide blocks, screws, and more. Custom inserts organize and protect contents, making it easier to keep everything for Kreg Joinery™ in one place. A transparent lid and a pair of heavy-duty clasps secures the lid, and a large handle makes the Organizer easy to carry.



161224 **\$39.99**



Kreg Jig® Mini Kit

Kit includes: Mini Jig, HSS 3/8" step drill bit, stop collar, and hex key.

144740 Kreg Jig® Mini Kit..... **\$19.99**

141942 Kreg Jig® Mini only..... **\$10.99**



Kreg Jig® K5 Pocket Hole System

Build it yourself, and build it better in just three easy steps: Drill. Drive. Done! The new advanced Kreg Jig® K5 incorporates the best features of earlier models with enhanced simplicity and versatile improvements to a proven design. The system adds an all new innovative clamping system and material supports with integral storage to the proven three-hole removable drill guide block and efficient dust collection port. Kreg Joinery™ is an incredibly fast, easy way to create strong joints in your woodworking projects. K5 offers a tool-free workpiece clamping system with a ratcheting clamp follower and front mounted ergonomic actuating handle and uses the same removable drill guide block to maintain compatibility with the Micro Pocket Drill Guide™ and Kreg Jig® HD. Two large support wings can be attached easily to the K5 base sides, for a solid footing with long workpieces, and includes a large storage compartment keeping bits, screws and accessories at hand but out of the way. With a swiveling dust-collection port, spring-loaded indexing pin for the drill guide block and a foolproof depth collar setup gauge, you have quite simply the most advanced Kreg Jig® yet! Original three-hole drill guide block with 9/16", 7/8", and 1 7/16" center-to-center spacing is adjustable for workpiece thickness settings of: 1/2", 5/8", 3/4", 7/8", 1", 1 1/8", 1 1/4", 1 3/8", 1 1/2".

When you're ready to create Kreg Joints, the K5 makes it simple. Just select your screw based on

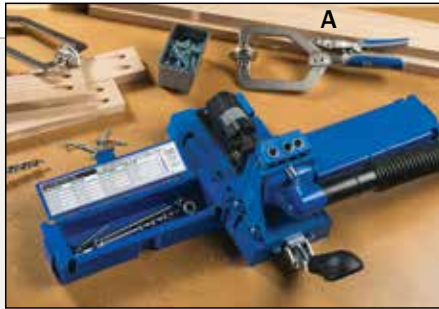

thickness of your wood, set the stop collar using the Depth Collar Setup Gauge, pull the spring-loaded pin to adjust the Drill Guide Block, and then set the workpiece clamp.

Includes: Kreg Jig® K5 base, drill guide block, two extension wings, dust-collection port, face frame stop, depth collar gauge, stepped drill bit, driver bit, stop collar, hex key, user guide, starter screw and plug pack.

The Kreg Jig® K5 Master System offers the best value adding the speed and efficiency of the Automaxx® Face Clamp and the handy Portable Base to the already feature packed Kreg Jig® K5 Pocket Hole System.

- 161223 Kreg Jig® K5 master system\$159.99
- 158631 Kreg Jig® K5 pocket hole syst. \$129.99
- 860863 screw selector wheel\$9.99

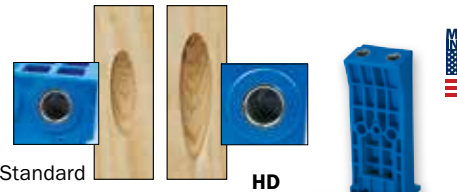

Kreg Jig® HD Heavy-Duty Pocket Hole System

Imagine being able to create joints an amazing 50% stronger than the already incredibly strong traditional Kreg Joints™. Imagine this joinery being as simple as Drill - Drive - Done! Well, now even the biggest projects are a reality with the all new Kreg Jig® HD! Utilizing the same tried-and-true efficient design and hardened steel drill guides as the original Kreg Jig®, the Kreg Jig® HD lets you drill holes which are 25% larger and fill them with massive Kreg HD screws. Kreg Jig® HD is made to work with 1 1/2" and thicker material to confidently build outdoor furniture, fences, trellises, railing on decks and more. HD stands for Heavy-Duty, and it all starts with a screw that is 25% larger than traditional Kreg pocket screws. Of course bigger screws require a bigger pocket hole, and the 1/2" diameter step-drill bit with 1/4" pilot works with the Kreg Jig® HD to place that pocket hole correctly to make Kreg Joinery™ HD style! Stopblock provides easy, repeatable registration to workpiece for simple setup and convenient operation. Kreg Jig® HD guide conveniently fits Kreg Jig® K3 and K4 benchtop base for shop use. Hex-shank HD drill bit is quick-change compatible with most impact drills currently on the market. HD Starter Kit includes: drill guide, stopblock, 1/2" step-drill bit with stop collar, 6" #3 square driver bit, and sample HD screws

- 154345 Kreg Jig® HD starter kit.....\$59.99
- 154346 Kreg Jig® HD step-drill bit\$19.99
- 154347 #3 SQ x 6" driver bit.....\$6.99

Kreg Jig® HD Screws - substantial #14 shank size and larger #3 SQ drive washer-head with three layer anti-corrosive Protec-Kote in a neutral color.

- 154348 #14 x 2 1/2" HD screws, 30 cnt.\$5.49
- 154349 #14 x 2 1/2" HD screws, 125 cnt. \$19.99

Kreg Jig® K4 Master System

Kreg Tool's most popular Kreg Jig® just got better. The new Kreg Jig® Master System includes the same K4 Kreg Jig® advertised nationally in the broadcast infomercial along with all the accessories you need to experience Kreg Joinery™ at a higher level. Build projects even better and easier than before. The new Master System will have you building strong joints right out of the box. Kreg Jig® K4 Master System includes: Kreg Jig® K4 with dust-collection attachment, face clamp, portable base, 3-hole drill guide block, drill guide spacer, material support stop, quick-change drill bit, 6" driver, 3" driver, starter screw & plug set, quick start guide and Skill Builder DVD..

- 151277\$139.99
- 860863 screw selector wheel.....\$9.99



Kreg Jig® K4

Kreg Jig® K4 is the perfect choice for DIY enthusiasts or anyone new to pocket-screw joinery.

- 149264 Kreg Jig® K4, only.....\$99.99
- 151243 acc. portable base.....\$19.99
- 149533 acc. dust shroud for K4.....\$9.99
- 147861 acc. drill guide block.....\$34.99
- 149534 acc. drill guide spacer\$9.99
- 833536 acc. support stop\$9.99
- 811112 replacement drill bit\$18.99
- 817629 replacement stop collar\$2.49

NEW!

Fine Thread



Course Thread

KREG® Zinc Coated Pocket-Hole Screws
Choose a fine thread screw for hardwoods or coarse thread for softwoods, plywood and composites.

- 149967 #6 x 3/4" fine panhead (100).....\$4.19
- 149968 #6 x 3/4" fine panhead (500)....\$16.79
- 161768 #6 x 3/4" fine panhead (1200) ..\$32.99
- 142690 #6 x 1" fine panhead (100).....\$4.49
- 840834 #6 x 1" fine panhead (500).....\$18.99
- 161769 #6 x 1" fine panhead (1200).....\$32.99
- 833070 #6 x 1 1/4" fine panhead (100).....\$4.69
- 153304 #6 x 1 1/4" fine panhead (500) ..\$18.89
- 161771 #6 x 1 1/4" fine panhead (1200) \$33.99
- 149570 #6 x 1 1/2" fine panhead (100).....\$5.19
- 834826 #6 x 1 1/2" fine panhead (500)....\$20.99
- 161772 #6 x 1 1/2" fine panhead (1200) \$37.99
- 142689 #7 x 1" coarse panhead (100).....\$4.49
- 161778 #7 x 1" coarse panhead (250)....\$10.99
- 833535 #7 x 1" coarse panhead (500)....\$17.99
- 161770 #7 x 1" coarse panhead (1200) \$32.99
- 142250 #7 x 1 1/4" fine (100).....\$4.69
- 161779 #7 x 1 1/4" fine (250)\$10.99
- 142251 #7 x 1 1/4" fine (500)\$18.89
- 161774 #7 x 1 1/4" fine (1200)\$33.99
- 824803 #7 x 1 1/4" fine (5000).....\$84.99
- 142252 #7 x 1 1/2" fine (100).....\$5.19
- 142253 #7 x 1 1/2" fine (500).....\$20.99
- 161776 #7 x 1 1/2" fine (1200)\$37.99
- 142257 #8 x 1" coarse (100).....\$4.49
- 148751 #8 x 1" coarse (500).....\$17.99
- 161773 #8 x 1" coarse (1200).....\$32.99
- 142246 #8 x 1 1/4" coarse (100).....\$4.69
- 161780 #8 x 1 1/4" coarse (250)\$10.99
- 142247 #8 x 1 1/4" coarse (500)\$18.89
- 161775 #8 x 1 1/4" coarse (1200)\$33.99
- 824804 #8 x 1 1/4" coarse (5000).....\$84.99
- 142248 #8 x 1 1/2" coarse (100).....\$5.19
- 161781 #8 x 1 1/2" coarse (250)\$12.49
- 142249 #8 x 1 1/2" coarse (500).....\$20.99
- 161777 #8 x 1 1/2" coarse (1200)\$37.99
- 834689 #8 x 2" coarse (50).....\$3.69
- 834690 #8 x 2" coarse (250).....\$14.69
- 146593 #8 x 2 1/2" coarse (50).....\$5.19
- 161782 #8 x 2 1/2" coarse (125).....\$12.49
- 145752 #8 x 2 1/2" coarse (250).....\$18.89
- 149084 screw assortment kit SK03.....\$29.99

KREG® Blue-Kote™ Outdoor Screws

Used for the majority of exterior pocket-screw applications and general exterior construction.

- 148478 #8 x 1 1/4", outdoor screw (100) ...\$6.29
- 148479 #8 x 1 1/2", outdoor screw (100) ...\$6.79
- 148480 #8 x 2", outdoor screw (50).....\$4.49
- 148481 #8 x 2", outdoor screw (250)\$16.79
- 148482 #8 x 2 1/2", outdoor screw (50)\$5.79
- 161783 #8 x 2 1/2" outdoor screw (125).....\$13.99
- 148483 #8 x 2 1/2", outdoor screw (250) \$20.99
- 149085 screw assortment kit SK03B.....\$39.99

KREG® 305 Stainless Steel Screws

Used for outdoor and marine applications.

- 148881 #8 x 1 1/4", coarse screw (100)\$18.99
- 148882 #8 x 1 1/4", fine screw (100).....\$19.99
- 148883 #8 x 1 1/2", coarse screw (100)....\$20.99
- 148884 #10 x 2 1/2", coarse screw (50)\$25.99

KREG® Pocket/Micro Pocket Hole Plugs

These real wood pieces are precut at the proper angle to fill and hide Micro Pocket and pocket-holes. Just glue and sand flush.

- Package of 50, pocket\$7.99
- Package of 65, micro pocket\$7.50

	Pkg. 50	Pkg. 65
maple	140084	848173
pine	141946	152623
oak	141947	848174
cherry	141943	848172
walnut	141944	N/A
cedar	142693	N/A

Paint Grade Plugs

- 147865 pocket paint grade (50).....\$5.99
- 848175 micro pocket paint grade (65).....\$4.99

Hand Tool Mastery



Rob Cosman has turned a professionally trained furniture making career into a career of teaching and coaching others in the woodworking skills of past generations. His DVD's are produced by award winning "Outreach Productions" and deliver top quality cinematography and audio. Join Rob daily at www.robworkshop.com for daily, interactive hand and power tool woodworking instruction.

Hand-Cut Dovetails Shop Copy Manual

A companion to the DVD, *Hand-Cut Dovetails Shop Copy* is a full-color, instruction manual. 84 pages.

840743\$24.95



Advanced Hand-Cut Dovetails DVD

Instruction on hand-cutting hounds tooth, half-blind and mitered edge dovetails. 60 minutes.

830245\$22.95



Rob Cosman's Dovetail Degree DVD Set

The *Dovetail Degree* includes the *Hand-Cut Dovetails 2.0* DVD, *Advanced Hand-Cut Dovetails* DVD, *Bench Chisels* DVD, and the *Hand-Cut Dovetails Shop Copy* book.

161792\$89.95

Scraping Wood DVD

Rob Cosman coaches you through the steps of tuning, sharpening and using scrapers. 1.5 hrs.

842421\$29.95



Rough To Ready DVD

Rob takes a piece of rough Mahogany through the paces of becoming straight, flat and true on all six surfaces. 47 minutes.

829247\$22.95

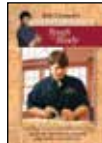

Hand Planing And Sharpening DVD

Learn sharpening and use of four basic shop hand planes, the block, the smoother, the jointer and the rabbet plane. 45 minutes.

833932\$22.95



Drawer Making – The Professional Approach DVD

Learn to make piston-fit drawers, a hall-mark of craftsmanship. Double DVD Set. 2 hours, 15 minutes.

834792\$37.95



Hand-Cut Mortise And Tenon DVD

Create mortise and tenon joinery with hand tools using a mortise chisel, mallet and tenon and arc saws. Double DVD set. 2 hours, 10 minutes.

834793\$39.95

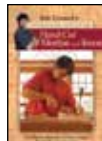

The Great Hand Plane Revival DVD With Rob Cosman

Watch Rob rework every part of a hand plane and explain the function of each part. You'll see him use the Pinnacle Matched Blade and Chipbreaker that allows old planes to be retrofitted with 9/32" thick blade/breaker combination. 90 minutes.

150791\$29.95



The Wood-Hinge Box DVD

Learn how to make the jigs to turn would-be scraps into beautiful wood-hinged boxes. 1 hour, 40 minutes.

147885\$32.50



Rob Cosman's Dovetail Mallet

Rob generated so many customer requests for his mallet that he decided to put it into production. A 2 1/2"-diameter (centerline) Bubinga head, full length Ash handle, hockey-style taped grip and a weight close to 3/4 lb. make this mallet a pleasure to use. This mallet also serves well as a carving or general shop mallet.

849314\$59.95



Rob Cosman's Dovetail Marking Knife

Working with renowned blade manufacture IBC, Rob Cosman has re-created every aspect of his most trusted tool, the Dovetail Marking Knife. The handle is made of cast aluminum, and the rectangular shape ensures proper blade orientation. The IBC blade has a standard bevel and micro bevel that prevents the blade from wandering, especially on end grain, and the thin blade allows for marking in the tiniest of openings. The 1 1/4" long blade has a slightly rounded cutting surface that allows full contact with the wood surface. Handle length is 6".

153622\$46.99

153623 (A) repl. blade\$19.99

159915 (B) saw tooth repl. blade\$25.99



WoodRiver® Wheel Marking Gauge

Made in the same factory as our WoodRiver® hand planes, you will immediately recognize the craftsmanship and value in this tool. Our 6 1/2" long gauge has a precision ground brass fence with a finely turned knurled knob, graded stainless steel shaft, a finely honed blade. The blade is replaceable.

154340\$39.99

154341 replacement wheel blade\$3.99



WoodRiver® Max Awl

Awls make holes, usually to start screws in wood or to push thread or lace through leather. The WoodRiver® Max Awl is an elegant, beautiful interpretation of this age-old tool. Overall tool length is approximately 5". The base of the 3" shank is 5/8" in diameter and tapers to a fine point at the tip.

151300\$21.99



Rob Cosman's Professional Joinery Saws

After teaching thousands of students to cut woodworking joints by hand, Rob Cosman saw the many problems people had when using traditional dovetail saws. In response, Rob has designed and developed a line of saws to address the problems he observed. The heavy brass back makes these saws "heavier," providing a natural downward pressure for smooth, vibration free cuts. Each saw has an overall length of 15 1/8", blade length of 10", and cutting depth of 1 5/8" and produces a .024" kerf. Composite handles, in ebony, provide a comfortable fit. Rob personally tests each saw prior to shipping in a handcrafted walnut and aspen case.

The **Dovetail Saw** blade has super fine 22 TPI at the tip for starting cuts and 15 TPI for finishing cuts quickly.

The **Crosscut Saw** has an aggressive 15 TPI to quickly cut clean tenons.

The **Tenon Saw** has 20 TPI for starting cuts and 12 TPI for efficient ripcuts. The Tenon Saw is slightly larger with a blade height of 2 3/4" and 12" in length.

150090 (A) dovetail, ebony\$249.99

150762 crosscut, ebony\$249.99

153307 (B) tenon, ebony\$299.99

Rob Cosman's Angle Trainer

Free hand sharpening is learned through practice, but Rob's new Angle Trainer helps you develop the muscle memory to learn faster. The Angle Trainer, your sharpening "training wheels," helps you learn, by holding your plane blade at the proper angle for primary and secondary bevels as you sharpen. You'll be sharpening just like Rob!

150879\$30.99



Rob Cosman's Dovetail Marker

Rob's dovetail marker allows you to lay out both the angled face and the squared end cuts. Made from Eastern Maple, Rob planes the angles on a shooting board to ensure accurate gauges. One side is 1:6 for lay outs on softwoods, the other side is 1:7 for hardwoods. The top of the gauge is wide enough to mark 1 3/16" material.

842423\$24.95



WoodRiver® Mini-Awl

This classy looking Mini-Awl is great for marking and making starting holes for those tiny screws that come with box hinges or for any other small screws. It is approximately 3 3/4" long, with a bubinga handle and a high carbon tool steel business end with a very fine point.

160352\$14.99



PINNACLE® Plane Blades

Woodcraft is proud to introduce Pinnacle® plane blades. Made from high quality, raw materials and razor sharp out of the box, a quick honing before installation in your hand plane will enable you to produce tissue paper thin shavings. The strict attention to detail and overall precision of these replacement, premium plane blades mean you spend less time prepping and more time woodworking! All blades 100% Made in Canada.

- Honed Razor-Sharp
- A-2 Tool Steel
- Double Tempered to 60-62 Rc
- Fully Stress-Relieved and Air Hardened
- Cryogenically Treated
- Fully Demagnetized
- Precision Ground Top/Bottom With Hand Polished Sides
- Micro-thin Film, Water Soluble Rust Inhibitor With Rust Inhibitor

See what Rob Cosman says about our WoodRiver® V3 Bench Planes- visit robcosman.com

Primary 25° Bevel
From Manufacturer

Secondary 29° Bevel

Tertiary 31° Bevel

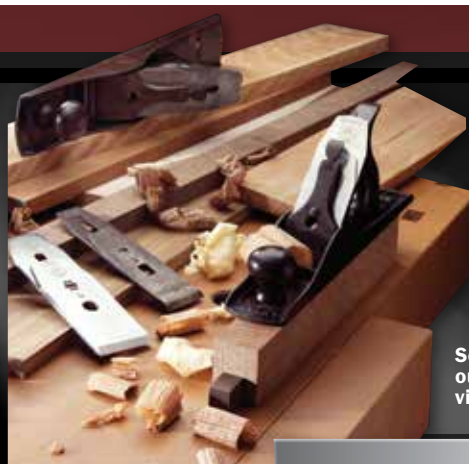

PINNACLE®/IBC Blades & Matched Chip Breaker & Blade Sets For WoodRiver® & Lie-Nielsen® Style Bench Planes

Performance begins with the blade. IBC uses high quality materials and machines these blades to be razor sharp out of the box. With just quick honing before installation, you'll be producing tissue paper thin shavings. Strict attention to detail and overall precision means you spend less time prepping and more time woodworking. IBC's quest for perfection doesn't stop with the blade. A better blade deserves a better chipbreaker. The innovation starts with design and materials: O-1 Steel is hardened to 30-32HRC then precision machined and sharpened to provide a durable, perfectly-mating edge that fully supports the blade. This greatly reduces vibration and chatter which leads to a finer, consistent shaving. Each chipbreaker is matched - ground and serialized to its blade at the time manufacture for a perfect match. Made in Canada.

Blades

150061	1 3/4" W for #3, #5 1/4	\$41.99
150062	2" W for #4, #5	\$41.99
150063	2 3/8" W for #4 1/2, #5 1/2, #6, #7	\$53.50

Matched Blade/Chipbreaker Sets

150893	1 3/4" W for #3, #5 1/4	\$74.99
150894	2" W for #4 & #5	\$94.99
150895	2 3/8" W for #4 1/2, #5 1/2, #6, #7	\$99.99

PINNACLE®/IBC Matched Chip Breaker & Blade Set For Stanley Style Bench Planes

Now you can revive antique Stanley/Bailey hand planes using the premium Pinnacle Blade and Chipbreaker Sets. The exclusively designed **Chipbreaker Blade Adjustment Tabs (A)** allows thicker premium blades/chipbreakers to function in antique planes' mouth opening to accommodate this blade. Made in Canada.

150812	1 3/4" W for #3 & #5 1/4	\$94.99
150813	2" W for #4 & #5	\$94.99
150814	2 3/8" W for #4 1/2, #5 1/2, #6 & #7	\$104.99
150791	(B) The Great Hand Plane Revival DVD	\$29.95

PINNACLE®/IBC Replacement Blades For Stanley/Record Style Bench Planes

150592	Stanley/Record #3, #5 1/4	\$54.99
150047	Stanley/Record #4, #5	\$57.50
150048	Stanley/Record #4 1/2, #5 1/2, #6, #7	\$59.99
150053	Stanley #9 1/2 block, 11-slot	\$44.99
150035	Stanley #51/52 spokeshave	\$21.50



BORA Restore Products

for thorough rust removal & prevention

BORA MetalGuard Ultra, 250ml

MetalGuard Ultra is a high specification thin film coating that complies with defense standard 68-10/2 (PX24) and NATO CODE C-634. Under typical workshop conditions it can be expected to provide protection for up to two years.

158703\$29.99

BORA Restore Rust Remover, 250ml

Restore Rust Remover is a water-based concentrate that removes rust and is nonacidic, nontoxic and biodegradable. This bottle makes 5 liters of derusting solution which can be used and reused until the solution becomes blackened - making it very economical. Simply submerge the rusty item in the solution and watch the rust go away.

158699\$29.99

BORA ProtecTool Wax Polish, 100ml

ProtecTool Wax is a unique blend of soft microcrystalline waxes and corrosion inhibitors that hardens on exposure to air. Apply with a soft cloth, allow to dry for a five minutes and then buff. In addition to protecting your tools, it also dramatically reduces friction.

158701\$19.99



BORA Restore

Blade & Bit Cleaner, 500ml
Restore Blade & Bit Cleaner is a water-based, fast acting, professional strength cleaner formulated to efficiently remove pitch and resin buildup from table saw blades, circular saw blades, router bits, spindle molder tooling and drill bits. It also contains a corrosion inhibitor.

158704\$34.99

BORA HoneRite Gold

Honerite Gold is a universal grinding, honing and lapping additive that makes water noncorrosive while also containing water soluble corrosion inhibitors. This is great news for users of waterstones, who will no longer have to worry about rust immediately after sharpening.

152586\$29.50

BORA Restore Rust Remover Gel, 250ml

Restore Rust Remover Gel has been developed to de-rust larger bulky/heavy items such as table saws, bandsaws, jointers, planers, auto body parts, tanks and mudguards, machine tool tables and beds. Restore Rust Remover does not contain acids. Apply with your scouring pad gently over the surface. The gel is extremely fast working; in many cases cleanup occurs in a few minutes.

158698\$29.99

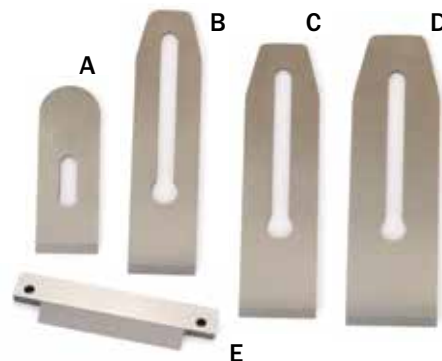

WoodRiver® Plane and Spokeshave Blades

High carbon tool steel blades for the WoodRiver® Block, Bench and Specialty Planes.

153916	(A) WoodRiver® Block Planes	\$13.99
153917	(B) 1 3/4" W for #3, #5 1/4	\$15.99
153918	(C) 2" W for #4, #5	\$16.99
153919	(D) 2 3/8" W for #4 1/2, #5 1/2, #6, #7	\$20.99
153920	(E) WoodRiver® Spokeshave	\$7.99



Helping You Make Wood Work®

WoodRiver®

WoodRiver® V3 Bench Planes

Introducing the New and Improved Version 3 WoodRiver® Bench Planes.

Our new Version 3 bench planes are still based on the reliable Bedrock design and feature heavy, stress-relieved, ductile iron castings, fully machined adjustable frogs and high carbon steel blades but we took the opportunity between manufacturing runs to conduct a critical review and incorporate a few improvements. We've changed the shape of the rear tote for a more comfortable grip and increased the diameter of the blade adjustment wheel for easier blade advancement. A more robust lateral adjustment lever, with a traditional style bearing provide better blade control and improved castings result in better "feedback" to the user. Working closely with the manufacturer, we continue making improvements in functionality, while producing hand planes of extraordinary value that are meant to be used. These planes have soles and sides machined flat and square and feature lightly finished Bubinga handles. These tools require minimal tune-up before use.

No. 1 The WoodRiver® Smoothing Plane was the smallest of Stanley bench planes but was perhaps the most infamous, being sought after by collectors because of its scarcity. Originally sold to handle small smoothing jobs, sometimes in tight places, this plane is often held in the palm of the hand as one would use a block plane. Like all WoodRiver® V3 Hand Planes, the No. 1 features a ductile iron body precision machined to be flat and square, brass screws and an adjuster knob, plus a beautiful finished Bubinga knob and tote. However, unlike its larger siblings, the No. 1 does not have a lateral adjustment lever. At 5³/₄" L x 1¹/₂" W and 1.3 lbs., it's just a tad heavier than the original Stanley. But don't let its size fool you: the WoodRiver® No. 1 is a fully functional plane that is very much at home in the workshop making shavings!

159005 (A)\$119.99



WoodRiver® Adjustable Mouth Block Planes

These WoodRiver® Block Planes are based on the venerable Stanley #65 low angle and #18 standard angle "Knuckle Cap" design, generally considered one of best block plane designs around. With the widely recognized comfortable chrome plated Knuckle Cap, these block planes look like the standard and low angle versions of yesteryear. Upon closer inspection you'll notice changes to the base castings which not only strengthen historically weak points of the original design, but also improve the blade bedding area. Improved blade adjustment mechanisms allow for crisp, easy adjustment of the blades using

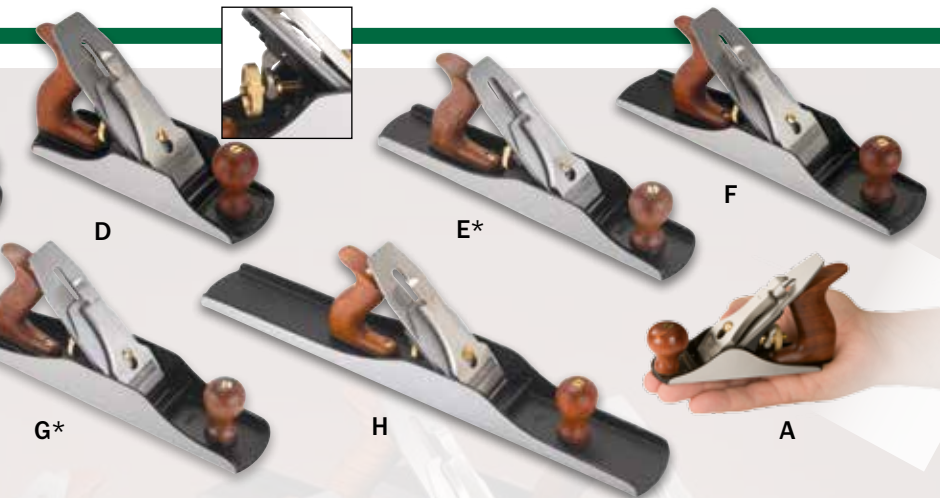

No. 3 Slightly smaller and lighter than the No. 4, this plane is well suited for smoothing smaller surfaces, or maneuvering around troublesome grain. Slightly longer than a block plane, the tote makes it more comfortable for extended use. The 9⁵/₁₆" long x 2¹/₄" plane partners perfectly with the longer No. 5. Wt. 4¹/₂ lbs.

150873 (B)\$139.99

No. 4 A versatile tool, the No. 4 ideal for smoothing and other light jobs where you don't need the length or heft of a larger plane. Weighing in at 5 lbs., this 9⁷/₈" long x 2⁷/₁₆" wide plane is light enough to use for longer periods, but has plenty of heft to slice through difficult grain without stopping.

150874 (C)\$144.99

No. 4¹/₂ The WoodRiver® V3 #4¹/₂ smoothing plane is 2⁷/₈" wide, 10³/₈" long, has a 2³/₈" blade, and weighs just over 6 lbs. Commonly referred to as a smoothing plane, the #4¹/₂ offers the user more heft, size and a larger tote than a traditional #4.

158001 (D)\$169.99

No. 5 An all-purpose plane, the No. 5, or jack, plane can perform most planing tasks. Nearly a full 14" in length with a 2⁷/₁₆" sole, this 6 lb. No. 5 is useful for stock removal, smoothing, shooting miters, and jointing smaller work.

150875 (E)\$169.99

No. 5¹/₂ The WoodRiver® V3 #5¹/₂ jack plane is 2⁷/₈" wide, 14¹⁵/₁₆" long, has a 2³/₈" blade, and weighs slightly over 7 lbs. The #5¹/₂ is generally thought of as an all-purpose plane capable of

performing the smoothing tasks of the smaller planes and the jointing tasks of the larger planes.

158002 (F)\$194.99

No. 6 The No. 6, also called a "fore" plane is good for jointing edges and flattening and smoothing large surfaces, such as table tops, panels and workbench tops, where you might not want or need the length or weight of a larger plane. The 17³/₄" long x nearly 2⁷/₈" wide sole enables it to shave bumps and bridge over valleys 7⁷/₈" wide better than a shorter plane and weighs 7³/₄ lbs.

150876 (G)\$194.99

No. 7 The No. 7, also called a "jointer", is used for creating a true edge, for edge to edge gluen ups. The length of this plane also makes it the tool of choice for flattening face surfaces of longer boards. The No. 7 is 22" long, 2⁷/₈" wide with a 2³/₈" blade and weighs 9¹/₂ lbs.

153104 (H)\$304.99

WoodRiver® Ultimate V3 Bench Plane Set*

The Ultimate V3 Set includes 4 planes — #3, #4, #5 and #6 — each featuring heavy stress relieved ductile iron castings, precise machining and extra thick plane blades.

152762* Buy The Set And Save!\$559.99



WoodRiver® Ultimate Cabinetmaker's Kit

The WoodRiver® Ultimate Cabinetmaker's Kit includes the three planes cabinetmakers prefer: the WoodRiver® V3 #4 plane for smoothing, the WoodRiver® V3 #6 Foreplane for jointing work, and the WoodRiver® Low Angle Block Plane for trimming end grain and doing on the spot trimming. The WoodRiver® V3 Bench Planes are based on the classic, time-tested Bedrock design while the WoodRiver® Block Planes trace their ancestry back to Stanley's #65 and #18 "knuckle cap" block planes. Neither designs are faithful reproductions, but rather inspired interpretations of classics. All feature heavy stress relieved ductile iron castings, precise machining and extra thick blades. The resulting tools offer extraordinary performance and unsurpassed value.

152763 Buy The Set And Save!\$369.96

the rear adjustment knob. The adjustable mouth is very smooth to operate and allows fine tuning of the mouth for work ranging from coarse to creating whisper thin shavings. The stress relieved ductile iron castings are precision machined, flat and square. Each plane is outfitted with a high carbon tool steel blade, which is hardened to RC58-63 for maximum edge retention and ground to a 25° bevel. We recommend sharpening the blades prior to use, however they're impressively sharp right out of the box. The bed angles are 20° for the Standard and 12° for the Low Angle. 2"W x 7"L with 1⁵/₈" W, 0.125" thick blade.

151124 (A) 20° standard angle.....\$99.99

151125 (B) 12° low angle\$99.99

152764 Ultimate Block Plane Kit, A & B above ..

SAVE \$20\$179.98



WoodRiver® No. 62 Low Angle Jack Plane

Originally advertised as a plane for heavy stock removal across the grain, the No. 62 has found a home as a smoother and is quite popular among collectors. The WoodRiver® No. 62 is faithful to the original design, but is almost a full pound heavier at approximately 4.6 lbs. It features a body cast from ductile iron, with a bed angle of 12°, an adjustable mouth, bubinga tote and front knob, and a high-carbon steel blade, with a 25° bevel. The plane measures a little less than 14" in length x 2.4" in width and has a 2"-wide blade.

- 158755 No. 62\$199.99
- 158756 25° blade\$19.99
- 158757 40° blade\$19.99



WoodRiver® Shoulder Planes

Borrowing heavily from the traditional shoulder plane designs of Edward Preston and Sons while incorporating a few modern tweaks, WoodRiver® Shoulder Planes look and feel like shiny, new antiques. They're the result of over two years of extensive prototyping and testing, because we were not only after the classic look (that part was easy), but really wanted "more than just a pretty face." The classic shoulder plane features were retained – narrow bodies, slightly proud blades (to clean corners), sides square to the sole, flat bottoms and a necessary robustness – but a major new feature was added, an adjustable toe used to control the throat opening and help to minimize tear-out on end grain. The bodies are Cr40 stress-relieved ductile steel, machined square and flat, and the blades are Mn65 tool steel hardened to HRC60-64, with a blade angle 25° and set in the body at a bedded angle of 15°. The blade advancement mechanisms are smooth and precise. The end result is a line of classically inspired planes that work as good as they look.

WoodRiver® No. 91 Small Shoulder Plane

Body length 5³/₄", width 1/2", height 1⁷/₈"; Overall Plane length 6¹/₂", height 2³/₈"; weight: 12.4 oz.

- 159001\$129.99
- 159002 No. 91 Blade\$12.99

WoodRiver® No. 92 Medium Shoulder Plane

Body length 7", width 3/4", height 2¹/₂"; Overall Plane length 8¹³/₁₆", height 3³/₄"; weight: 2 lbs. 3.4 oz.

- 154032\$149.99
- 154033 No. 92 Blade\$14.99

WoodRiver® No. 93 Large Shoulder Plane

Body length 8¹/₄", width 1", height 3"; Overall Plane length 10⁷/₁₆", height 3⁷/₈"; weight: 3 lbs. 12.8 oz.

- 154004\$199.99
- 159003 No. 93 Blade\$15.99



WoodRiver® Side Rabbet Plane

Early side rabbet planes such as Stanley's 98/99 were available in right- and left-hand versions. Combination planes like the Preston 1369 and Record 2506/2506S offered the convenience of two blades in a single plane. The WoodRiver® Side Rabbet Plane takes its lineage from the 2506S and incorporates two manually adjusted blades and an adjustable depth stop. This handy tool is perfect for cleaning up rebates and grooves, ensuring a proper fit. The plane's precisely machined body is manufactured from 40Cr tool steel with a reversible, adjustable depth stop and features T10 steel blades hardened to RC59-63. The front of the plane is easily removable for conversion to a bull nose configuration for corners and stop dadoes.

- 151239\$74.99



WoodRiver® Chisel Plane

Think of a chisel plane as a chisel perched atop a wedge to control the angle with edge in front and a depth adjustment to control the cut. This simple idea has many practical applications from removing excess glue to trimming proud dowels and pocket hole plugs. The small chisel plane is 4¹/₂" long (5" OAL) by 1³/₄" wide, weighs 1¹/₂ lbs. and features a stainless steel investment cast body and Mn65 steel blades.

- 151301 small\$69.99

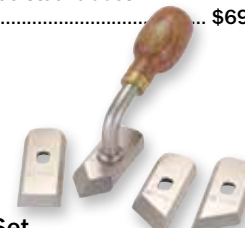

WoodRiver® Cranked Neck Chisel/Plane Set

This unique crossover design makes for an extremely useful tool. The offset handle permits the short chisel blade to glide along the surface like a plane removing excess dried glue with ease, cleaning out corners, trimming protruding dowels or pegs and who knows what else! Set includes 1 Bubinga handle and 4 interchangeable blades: Diamond Point, Straight, Left and Right Skew. Blades are 1" x 1³/₈" Mn65 Spring Steel hardened to RC56-60.

- 151240\$43.99

Hand Planes in the Modern Shop

Plane users, craftsmen who would like to become plane users, and plane collectors all will find a wealth of how-to information, backed with more than 500 images, in this definitive guide to hand planes. The use of hand planes results in a quieter, cleaner workshop and matches the efficiencies of power tools for many of the processes involved in making wood furniture. In addition to covering nearly 10 types of planes, this book also divulges some shop secrets for making a hand plane, restoring antique planes, and troubleshooting your planes. 192 pages, hardcover.

- 848046\$39.99



WoodRiver® Plane Sacks

Corrosion can deface any hand plane very quickly and if left unchecked, can ruin it. WoodRiver® Plane Sacks are environmentally safe and constructed from a unique cotton fabric containing an oil and non-migrating silicone base that prohibits corrosion. Not only do they protect your hand plane against corrosion, since the natural wicking fabric keeps moisture away from the tool, but they also guard against scratching, dirt and dust buildup. WoodRiver® plane sacks have a lifetime guarantee, so sack 'em up and quit worrying about corrosion. Available in four different lengths for all your planes. USA.

- 154625 block plane sack, 7¹/₂"\$12.99
- 154626 smoothing plane sack, 12¹/₂"\$13.49
- 154627 jack plane sack, 16"\$13.99
- 154628 jointer plane sack, 25"\$13.99



WoodRiver® Hand Plane Screwdrivers

The long and the short of it – literally! These beautiful, bubinga handled screwdrivers are fitted with CRV polished steel ferrules and blades ground to perfectly fit the screw heads in the WoodRiver® hand planes. Now you no longer have to worry about marring the screws when making adjustments or breaking a plane down for cleaning. The short driver's compact design, 7³/₄" in length with a 2" long blade, affords easy disassembly, while the longer driver, 12" in length with a 6⁷/₈" blade, is perfect for reaching the frog adjustment screws.

- 152804 small\$14.50
- 152805 large\$15.99
- 152806 set, small & large\$24.99



See your Woodcraft Store or visit woodcraft.com for a complete selection of Wetterlings Axes



WETTERLINGS The Compact Hatchet - "Buddy"

The smallest of all Wetterlings Axes, the "Buddy" is suitable for woodcarving or to use instead of a large knife. Thanks to the shape of the head, it also is functional for splitting smaller chunks of wood in front of your hearth. Its compact design and light weight make it easy to carry – in your belt, in the backpack or your toolbox. The hatchet blade is hand-forged Swedish carbon specially alloyed steel with an HRC57 edge hardness, and the handle is American hickory. Hatchet comes with a vegetable tanned, locally produced, leathersheath and a 20-year warranty. Approximately 1 lb., 8.7 oz. total weight; 10" overall length with a 2 3/4" face. Made in Sweden.

160335 \$104.00

The Perfect Edge

With over 25 years of knowledge and experience with tool steel metallurgy and cutting-edge geometry, author Ron Hock has developed the ultimate guide for sharpening. Dull tools are something that every woodworker will encounter on a daily basis, and sharpening these tools can be a daunting task. Some will choose the simplest method to sharpen their tools, while others will look for the superior method to achieve an unparalleled edge. This book includes information to help you understand what steel is, how it works, and how to bend and shape it to suit your needs.



157890 \$26.99

Technical Questions?

Call 1-800-535-4486
For FREE help, and advice!



Woodthreading Kits

This threadbox and tap, for cutting external and internal threads in wood, is useful for making clamps, jigs, fixtures, knockdown furniture, toys, and novelties. Although traditional in design, modern technology and metallurgical advances have improved the traditional threadbox and tap and perfected its components. Hardwood threadbox with turned handles has an aluminum insert to prevent wear and extend the tool life. Steel tap is machined to close tolerances and designed to allow easy chip clearance. The resulting wood thread is both tight fitting and strong. Available in five sizes. Includes threadbox, tap and instructions.

12T13 1/2" diameter x 8 TPI \$48.99
12T14 3/4" diameter x 6 TPI \$47.79
12T15 1" diameter x 6 TPI \$50.39
12T16 1 1/4" diameter x 6 TPI \$47.29
12T17 1 1/2" diameter x 6 TPI \$52.99
12T18 replacement cutter \$10.99



PINNACLE® Series #151 Spokeshaves

Spokeshaves are designed to turn square billets into rounds. The two versions of the Pinnacle® #151 series Spokeshaves, with either a flat or radius sole and are based on the classic 1911 Stanley gullwing design. These tools are manufactured from durable, rust resistant 304 stainless steel, and features a precisely machined 45° blade bed. We've duplicated the original double screw fine blade adjustment and fitted these tools with cryogenically treated, double tempered Pinnacle®/IBC A2 steel blades hardened to Rc 60-62. The #151s are 10 3/4" long, a robust 17+ oz. and utilize a 2"-wide blade. Each tool includes a wooden storage/presentation box with the Pinnacle logo and contains instructions for use, maintenance and care.

152803 (A) #151 Flat Sole \$104.99
153105 (B) #151 1/2 Radius Sole \$104.99
153310 Pinnacle® Replacement Blade \$29.99



WoodRiver® Spokeshave

Spokeshaves are used to shape and smooth chair legs, wheel spokes and rods of all sorts. The WoodRiver® shave is a robust casting of ductile iron featuring a high carbon RC60-64 blade and an adjustable front shoe to control the depth of cut. The heavy (1.05 lbs) cast iron body actually increases tool control, making it easier to shave with one or two hands. This, combined with the adjustable shoe for depth control will make this one of your favorite hand tools.

150740 \$54.99

WoodRiver® No. 80 Cabinet Scraper

Produces a glass smooth finish on straight grained as well as highly figured woods. Thumbscrew adjustment can be set to cut a fine shaving or tightened to produce a coarse cut. Sole is 84mm (3 1/4") x 68mm (2 5/8").

149157 \$42.99



Bottoming taps for cutting threads to the bottom of a blind hole. Use it after a regular tap.

12T19 1/2" bottoming tap \$17.89
12T25 3/4" bottoming tap \$19.99
12T26 1" bottoming tap \$20.99
12T27 1 1/4" bottoming tap \$26.29
12T28 1 1/2" bottoming tap \$29.99



TANOS Systainers® Protect Your Planes!

The Systainer® are well organized and easy to move. The unique patented case system enables all Systainers® to be stacked and linked together. T-LOC catch enables one-handed locking, opening and connecting for fast linking of individual units so they can be carried as a single unit.

157939 T-LOC I, anthracite \$69.00
157997 lid foam \$6.50
158011 filler foam \$26.50

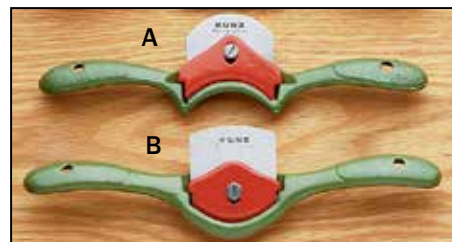

KUNZ Spokeshaves

(A) **Half-Round Spokeshave** with a concave face blade for easy shaving of round stock. Length 10", blade width 2 1/16". Honing is required before use.

16B02 \$43.50
16G13 replacement blade \$14.50

(B) **Radius Spokeshave**. Sole and blade are ground to a 2" radius for smoothing concave surfaces. Length 10", blade width 2 1/16". Honing required before use.

01T11 \$43.99
01T12 replacement blade \$16.99

STANLEY® Spokeshaves

Adjustable blade spokeshaves are made of durable malleable iron with two adjusting screws for vertical and lateral blade adjustments.



The flat face trims flat and round stock while the curved face cuts a concave surface. Over lengths 10", blade widths 2". Honing required before use.

827102 flat face \$36.50



WoodRiver® Corner Easing Plane

Softening the edges on a board or plywood is easy with this nifty little Corner Easing Plane. Made entirely from high carbon steel, it works in both directions and is small enough to carry in your work apron or pocket. Cutting edges are built into the tool – no extra blades to buy. Plane is approximately 2 5/16" L x 3/4" H x 7/16" W and weighs 2.2 oz.

160252 \$14.99



HOCK Scratch Stock Tool And Blades

In the old days, decorative beads could be applied to the front of a drawer, cabinet or door with a tool called a Scratch Stock. This involved a wooden handle and fence with the means to hold a profiled steel blade which, when drawn across a wood such as a drawer front, created the desired profile. Working closely with blade maker Ron Hock, we are proud to introduce his modern adaptation made from high quality bamboo plywood and spring steel blades. The Hock Scratch Tool can be used on flat or curved surfaces and includes two blades, one with a precut profile to get you started. Extra blades, sold separately as a pack of four, can be used as replacements or for creating your own profiles. Blades are approximately 3/4" wide, 1 3/4" long, 0.05" thick. Comes with complete instructions for setup and use.

- 153782 \$31.99
153783 blades, 4-pack \$6.50



HOCK Blades And Chipbreakers

Handmade and 17% thicker than standard blades, allowing closer throat-opening settings, finer shavings, and reduced chatter. High carbon (.95%) tool steel and hardened to Rc62, they hold a razor-sharp edge. Fits Stanley, Bailey, Record, Footprint, and most other planes. 3/32" thick, USA, honing required before use.

Bench Plane Blades are 7" long.

- 04B21 1 3/4" blade \$37.50
04B22 2" blade \$39.50
04B23 2 3/8" blade \$42.99
04B25 2 5/8" blade \$48.99

Block Plane Blades are 4 1/2" long with rear depth adjustment grooves. Wide-slot blades only fit the new Stanley block planes.

- 04B34 1 3/8" blade \$37.99
04B35 1 5/8" blade \$39.99
04B36 1 3/8" wide-slot blade \$36.99
04B37 1 5/8" wide-slot blade \$37.99

Spokeshave Blade is 1 7/8" long.

- 04B33 2 1/8" blade \$33.50

HOCK Chipbreakers. Upgrading your plane with a Hock Blade? Add one of their Chipbreakers for the ultimate plane blade tune-up! Most standard chipbreakers are only .065 to .070" thick - too thin to add much strength. Hock Chipbreakers are .118" (3mm) thick for added mass, rigidity and support for the cutting edge.

- 144182 1 3/4" chipbreaker \$35.50
144183 2" chipbreaker \$35.50
144184 2 3/8" chipbreaker \$35.50



Timber And Log Saws

One Man Crosscut Saw. Perfect for timber framing, log building, or any heavy cutting job. Use the starting teeth to introduce a kerf, then the 3 TPI main teeth, which cut on both the push and pull stroke, to quickly slice through the toughest jobs. This heavy duty, hand hammered German saw has a 32" blade.

- 03P52 \$99.99

Shingle Froe

This is the tool used by colonial settlers to split shingles, shakes, and lumber for homes in early America. Simply pound the blade of the froe into the end of a short log with a mallet or maul, then pull back on the handle to split off a slice of the wood with the grain. Handle is 18" long; blade is 15" long and 2" deep. Roughly finished. Made in USA.

- 147901 \$64.50



Two Man Crosscut Saw. Whether you're building a timber frame home or cutting a few pieces of firewood, this saw will make short work of slicing through the toughest wood. The 4 ft. German blade is hand sharpened and set, ready to take on the heaviest cutting jobs. Overall length 52" with 8 1/2" hardwood handles.

- 144795 \$144.99



PINNACLE® Socket Firmer Chisels

Pinnacle heavy-duty socket firmer chisels have thicker and longer sockets for added strength and durability. They're forged from a solid piece of high carbon tool steel which is then carefully tempered and hardened for toughness and edge retention. These are the best chisels available for timber framing, log cabin building and other demanding cutting jobs. Blade lengths are 7" to 8" with overall lengths 15" to 17". Chisels have ash handles fitted with a steel ferrule. Honing required before use.

- 154595 3/4" \$107.50
154596 1" \$119.99
154597 1 1/2" \$139.99
154598 2" \$154.99
154609 Set of 4 \$472.50
154599 3/4", 1" chisels repl. handle \$15.99
154600 1 1/2", 2" chisel repl. handle \$20.99



Dual Blade Tenon Cutters

Faster Cutting, Safer To Use And Longer Lasting!

The dual precision-ground blades cut twice as fast, retain their sharpness longer, never rust or clog, and generate less heat for long-lasting service. The "In-Sight" measurement system has slots and radial grooves set at 1/2" intervals - so you can eliminate manual re-measuring and re-cutting. Blades are made of rust-proof, hardened carbon steel. Self-centering design produces perfectly shaped tenons every time. Body is CNC machined from solid 6061 aircraft aluminum for maximum strength with minimum weight while 1/2" shanks are made of 303 stainless steel. For use on limbs up to 3 1/2" in dia.

- 147363 1/2" tenon diameter \$99.79
147364 3/4" tenon diameter \$141.79
147365 1" tenon diameter \$152.29
147366 1 1/2" tenon diameter \$173.29
147367 2" tenon diameter \$194.29



BARR

Timber Framing Chisels

Hammer forging packs the steel producing a very fine-grained, dense metal. This process also introduces more carbon into a smaller area. As a result you get a blade with remarkable edge holding ability without being brittle. Chisels feature fitted socket handles, steel ferrules, and are delivered shaving sharp!

- 145009 (A) 2" framing chisel \$144.99
145010 (B) 1 1/2" framing chisel \$144.99
145008 (C) 1 1/2", #5 sweep gouge \$114.99
149506 (D) 2 5/8" large slick \$192.50

Leather Tip Guard. Made from heavy saddle grade leather and hand stitched, the tip guard is furnished with an ABS plastic insert to protect the leather and the tool. Fits 1 1/2" and 2" framing chisels.

- 145011 (E) leather chisel tip guard \$22.99



気持

Japan Woodworker®

FOR THE SHOP, KITCHEN & GARDEN

For over 30 years, Japan Woodworker has imported professional quality tools from Japan.

Matsu Blue Paper Steel Chisel Set 10-piece — Matsumura



Close-Up



During a recent visit to Japan, we visited Mr. Shigezo Matsumura in his shop. He had just recently developed these extraordinary chisels, and we were taken aback by their quality and usefulness. Made from the finest Hitachi Blue Paper Steel,



Chisel Hoop

these shorter length chisels (5³/₄" overall) give the craftsman more control, but with greater results due to the quality steel. Mr. Matsumura personally sharpens each blade to a razor-like edge. The Ebony handles are a bonus, giving the user strength and comfort. The 10-piece set includes all of the most commonly used sizes from 1¹/₈" to 2" in metric dimensions, with the approximate inch equivalents, and comes in an attractive box that is signed by the maker.

The Matsumura Family has been producing woodworking chisels for well over 200 years. Mr. Shigezo Matsumura began his apprenticeship at the age of 15 and exhibited such skill that by the age of 25 he was able to open his own workshop. For over 60 years, first as an apprentice and now as a true Master of Blacksmiths, Mr. Matsumura has made chisels one at a time in the old tradition, preferring to use charcoal instead of gas in the forging and tempering process, because of its "soft heat," and only the finest white and blue steels for the cutting edges, which are laminated to wrought iron for strength. All cutting edges are tempered to HRC64 and sharpened for immediate use. Note: Mr. Matsumura operates a one-man shop and personally makes each tool, with an occasional assist from his wife.

161481 10-Piece Chisel Set \$1,449.00

Harvesting Shears



These harvesting Shears are used for picking fruit and flowers. The long blade and sharp pointed tips allow harvesting in difficult to reach areas, without damaging the fruit or surrounding foliage. The forged high-carbon steel blades are razor-sharp. The spring loaded handles are contoured to fit the hand and covered with soft plastic for a comfortable grip. A metal catch keeps the shears closed during storage. Overall length is 8", and blade length is 2".

155668 \$41.00

Tanaka Traditional Style Knife



This knife is used by Japanese hunters. It is designed for cutting meats in the field. The blade is a hand-forged lamination of high-carbon blue steel for sharpness and 16 layers of Damascus pattern soft steels for strength by master blacksmith Kazuyuki Tanaka. The handle is wrapped with nylon cord to ensure a firm grip even when wet. Blade length is 4", and overall length is 9". Each knife is sent razor-sharp with a blade cover.

155641 \$169.00

Hishika Dozuki Superfine Craft Saw



This saw is fully functional, like normal sized saws, and made to the same high standards. It comes from the same Hishika factory in Miki where many traditional professional saws are produced, and it is perfect for precision work with models and miniatures.

161000 60mm long x 0.1mm thick \$36.00

Tsunesaburo 55mm Blue Paper Steel Smoothing Plane — Akio Uzumi



159625
Shown

This plane is made from the finest blue paper steel, with a Japanese White Oak dai (body). A smoothing plane is used to smooth the roughness and tears of a wooden surface. Compared to a block plane, a smoothing plane has a bigger body and can be used to smooth large boards and lumber. The chipbreaker, which is the second blade that comes with the plane, breaks the wood fibers immediately after they are cut and reduces tears.

159623 42mm Smoothing Plane \$125.00

159624 48mm Smoothing Plane \$109.00

159625 55mm Smoothing Plane \$175.00



Tanka VG-10 Damascus Chef Knives

Experts at Tanka make this line of hot-forged custom chef knives. To achieve exceptional quality, the 33-layer Damascus blade features a core of VG-10 stainless steel, hardened to at least HRC60. The resin impregnated black Pakka wood handle is attached with stainless steel rivets.

A. 160991 150mm Petty \$155.00

B. 160992 170mm Santoku \$205.00

C. 160993 210mm Gyuto \$245.00

All-Purpose Garden Knife

Hori-hori, which means small digging tool, is marvelous for digging deep rooted weeds and planting bulbs and bedding plants. The saw teeth will cut through tough roots and branches. The front of the tool is shovel shaped for digging efficiency, and the back is beveled for easy sharpening. Each Hori-hori is forged from high-carbon tool steel and tempered for heavy-duty use. The Red Beech handle is riveted to the blade. A scabbard with belt loop is included. The blade width is 1³/₄", the blade length is 6¹/₂" and the overall length is 11¹/₂".

158807 \$26.00

PFEIL® Swiss Made® Butt Chisels

Butt chisels are easier to control in joinery applications than full-sized bench chisels. The faceted, contoured European Locust handles fit the hand comfortably but prevent the chisels from rolling off your bench. Blades are made of Swiss alloy tool steel and heat-treated using the latest technology for excellent edge holding. Chisels are ground and polished from the maker. Overall lengths are 6", blade lengths 3³/₈". The set includes 6mm (1/4"), 12mm (1/2"), 19mm (3/4"), and 25mm (1") chisels and includes a fitted wooden block to safely store and protect your chisels.

05B12	4-piece set	\$114.99
05B13	6mm (1/4").....	\$29.49
05B14	12mm (1/2").....	\$31.19
05B15	19mm (3/4").....	\$32.79
05B16	25mm (1").....	\$34.49



WOODCRAFT® 30-Pocket Tool Roll

Make sure all your hand tools have a home with the Woodcraft 30-Pocket Tool Roll. Hang it by grommets from your pegboard, bench or shop wall, or roll it up to stow and go. Adjustable straps allow the roll to accommodate your tools. Expanded: 22" x 19"; rolled size, empty: 13" x 7" x 4 1/2" (approximate). Black. Tools not included.

161202..... **\$19.99**



Securely Protects A Variety of Chisel Styles

WoodRiver® Silicone Chisel Edge Keep™

Edge Guards, Tip Protectors or whatever you call them, most are made from a somewhat hard plastic that either fits well because it's made for the chisel or it doesn't fit and slips off. Our WoodRiver® Guards are made from soft silicone. They'll fit over practically any chisel, stay on and actually protect the chisel's edge from hard knocks. Each package contains 10 guards: two each of 1/8"- 1/4", 3/8"- 1/2", 5/8"- 3/4", 7/8"-1", 1 1/8"- 1 1/4" to fit chisels from 1/8" to 1 1/4".

161193 10-piece set



WoodRiver® Chisel Set

Beautifully crafted, well balanced 6-piece bench chisel set made by the same folks making the WoodRiver® hand planes. CRV steel blades hardened to RC59-63 with steel ferrules and nicely finished off with genuine Bubinga handles which are as much a joy to the eye and as they are to hold. Set includes 1/4", 3/8", 1/2", 5/8", 3/4" and 1" chisels. Overall lengths 9 1/2" to 10 1/2" with blades lengths from 3 1/2" to 4". Honing required before use.

151268 6-piece set..... **\$89.99**



WoodRiver® Butt Chisel Set

Beautifully crafted, well balanced 4-piece butt bench chisel set. CRV steel blades hardened to RC59-63 with steel ferrules and nicely finished off with genuine Bubinga handles. These little beauties are truly fun to use. Like they're bigger brethren, they look impressive to the eye and really perform under use. Set includes 1/4", 1/2", 3/4" and 1" chisels. Overall length 6 1/2" with blades 2 3/8" long. Honing required before use.

152169 4-piece set..... **\$59.50**



WoodRiver® Bent Paring Chisels

WoodRiver® Bent Paring Chisels are a relatively simple solution for removing glue lines, trimming protruding plugs or cleaning out corners. We've taken our standard WR Bench Chisel and bent the tang at about an 18° angle. That provides the necessary relief to enable the user to grasp the handle while keeping the blade of the chisel flat on the work surface.

157916	1/4"	\$19.99
157917	1/2"	\$19.99
157918	3/4"	\$20.99
157919	1".....	\$21.99
100141	4-piece set.....	\$72.99

Technical Questions?

Call 1-800-535-4486
For FREE help, and advice!



SORBY Cabinetmaker's Bench Chisels

Feature classic octagonal boxwood handles – the old favorites of yesteryear's discerning craftsmen. The unique "London pattern" of handle with turned finger contours, flat milled body, and graduated sizing, promotes a more positive and natural grip for controlling your cuts. Fitted to finely machined bevel edged blades, each tool has a leather "anti-shock" washer between bolster and handle, and brass ferrules to prevent handle splitting. Each chisel is individually inspected and hardness tested to ensure you get a tool of the highest quality. Overall lengths 9 3/4" to 12 3/4", blade lengths 4" to 4 3/4". Set of four includes: 1/4", 1/2", 3/4", and 1".

07F20	set of 4	\$179.99
123413	set of 9	\$489.99
07F21	1/8".....	\$75.50
07F22	1/4".....	\$54.99
07F23	3/8".....	\$54.99
07F24	1/2".....	\$56.99
07F25	3/4".....	\$60.99
07F26	1".....	\$74.99
07F27	1 1/4".....	\$82.50
07F28	1 1/2".....	\$96.99
07F29	2".....	\$111.99



IRWIN/MARPLES®

Blue Chip® Bench Chisels

These bevel-edged chisels are hardened and tempered under controlled conditions and accurately ground for precise control. Handle is square with rounded corners for comfort and to prevent rolling; made of indestructible polypropylene to withstand heavy mallet and hammer blows. Overall lengths 9 3/4"-11"; blade lengths 3 1/2" to 4 1/4". Set of six, in a wooden box, contains one each as follows: 1/4", 3/8", 1/2", 3/4", 1" and 1 1/4". The complete eight piece set is not available as a boxed set. Honing required before use.

12G11	1/8".....	\$13.50
12G21	1/4"*.....	\$13.50
12G31	3/8"*.....	\$13.50
12G41	1/2"*.....	\$14.50
12G51	5/8".....	\$15.50
12G61	3/4"*.....	\$16.50
12G71	1"*.....	\$18.50
12G81	1 1/4"*.....	\$20.99
111165	4-pc. set - 1/4", 1/2", 3/4" & 1"	\$43.50
12115	*6-piece boxed set	\$74.99
12G20	set of 8 Save!.....	\$84.99

Chisels



Laser Engraving Available

STANLEY®

Sweetheart™ 750 Socket Chisels

Returning to their traditional roots, Stanley's new 750 socket chisels are forged from high chrome-high carbon English tool steel in the famous steel city of Sheffield and hardened to RC58-62. FSC Certified Genuine English Hornbeam (a member of the *Carpinus* genus) is used for the handles. Chisels range in length from 8½" to 10¾". Handles are approximately 47/16" in total length, with a 35/16" comfortably shaped grip area and a 11/8" tenon which fits into the socket on the chisel. Handles must be set in the socket prior to use. Like all chisels, these will require some flattening of the backs and honing before use, but we found them well-balanced and quite light. We all liked them so much we think these could easily become our favorite set of chisels. Sets come with soft leather tool rolls for storage, which can also be hung up for easy access to tools when in use.

152818 4-pc. w/tool roll \$129.99

152819 8-pc. w/tool roll (shown) \$229.99



NEW

FUGIKAWA

Chisel Set

These professional-grade chisels are made by Fugikawa and feature a thin layer of white steel laminated to a softer steel main body. Handles are Japanese Red Oak topped with a black steel hoop. This six-piece set includes sizes 6mm, 9mm, 12mm, 18mm, 24mm and 30mm width and 225mm length. Chisels are supplied in a wood box.

161018 6-piece set \$158.00

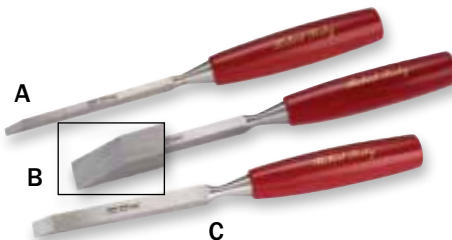

SORBY

332 Mortise Chisels

Sorby's 332 Mortise Chisels are a combination of the Sorby 331 Sash Mortise Chisel Blade with an unbreakable CAB (plastic) handle that can take a hit when removing stock. Each blade features side relief, making it easier to remove stock and, like all Sorby cutting tools, each chisel is tested for diamond hardness prior to leaving the factory. Lifetime guarantee.

154358 (A) ¼" \$43.99

154359 (B) ⅜" \$44.99

154360 (C) ½" \$45.99

WoodRiver® Utility Chisel Set

The bevel-edged WoodRiver® Chisels have impact resistant polypropylene handles that are contoured for ergonomic comfort and superior control. The 115CRV3 tool steel is heat treated on the ends to a hardness of 59-63 RC. Overall lengths 9¾", blade lengths 3¾". These chisels are factory ground and require honing before use. 4-piece set includes ¼", ½", ¾" and 1" wide chisels.

154323 \$39.99



Honing Guide Speeds Sharpening

You can hone edge tools between grindings with this unique self-centering guide. Chisels and plane irons from 1/16" to 25/8" wide can be held securely in one of the two sets of stepped jaws. The accurately ground hardened steel roller glides across the surface of the stone to allow for a consistently fine edge.

03A21 \$14.99



GRACE USA Brass Hammers

Grace USA Brass Hammers are made for the fire-arms industry, but we found them mighty useful around the shop. They're compact, heavy and perfect for assembling and disassembling machinery and furniture, any kind of chisel work where a mallet is needed, and adjusting wood hand plane blade depth. Available in three different head weights: 4 oz., 8 oz. and 16 oz. Made in the USA.

158873 4 oz. \$15.99

158874 8 oz. \$21.99

158875 16 oz. \$27.50



BEALL Wood Buff System

Give your next small project a spectacular finish quickly and easily with this set of three 8" diameter buffs, compounds, and a quick-change adapter. Whether you're polishing an oil finish on a box, buffing the scratches out of a turned bowl or platter, or finishing pen blanks, this system will leave a glass smooth surface on whatever you hold to it. The secret to the system is the dozens of soft cloth layers apply compound evenly without rounding over sharp features and edges. The wheel actually splays out slightly to conform to the shape being buffed. The all-flannel tripoli buff will level out the finish and remove any scratches. The flannel/cotton mix white diamond buff takes out any remaining small scratches and begins to polish. The all-cotton carnauba wax buff yields a high gloss polish, similar to a lacquer finish. Changing buffs takes seconds with the quick-change adapter; it adjusts to fit ½" or 5/8" motor arbor shafts (½ HP or larger, 1725 RPM motor recommended). The optional #2 Morse Taper mandrel enables you to use the buffs on the lathe (you'll have to make a ¼"-20 drawbar to hold it in place). The compounds will last for years when used moderately. Complete instructions included. Not for use in a hand-held drill. System includes 3 buffs, quick-change adapter and 3 compounds.

141069 wood buff system \$80.50

141070 #2 MT mandrel \$12.99

141073 tripoli bar (6" x 2" x 1") \$6.99

141072 white diamond bar (6" x 2" x 1") ... \$6.99

141071 carnauba bar (5½" x 2" x 5/8") \$6.99

827106 mandrel adapter \$21.99

Quick Cutting Corner Chisels

Perfect for squaring up "round corners" on hinge mortises, our spring loaded chisel is made of hardened steel and is sharp, ready to use right out of the box. Tap lightly with a hammer and you have a perfectly squared corner. Either cutter is 3/8" x 3/8" and a perfect 90°.

WoodRiver®
143717 (A) \$19.99

WHITESIDE
24225 (B) \$30.50

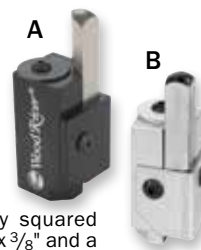

Precision Crafted Dog Leg Chisels

Offset 1¼" long tool steel blades have 5/16" cutting edges tapered back to their necks for the proper undercutting clearance in, jointwork and sizing operations. 3¾" hardwood handles. Factory sharpened and ready for use.

11Q10 set of 3 \$39.99

11Q51 straight chisel \$15.99

11Q52 right skew \$15.99

11Q53 left skew \$15.99



BEALL 3-On Lathe Buffing Mandrel

One end of the 18" mandrel (requires 18" between centers) is machined to a #2 Morse Taper to fit in the head stock of your lathe, the other end is machined to accept the tail stock. Now you can quickly and efficiently take small items through three steps of buffing without stopping to change buffs. Kit contains the mandrel with spacers, three buffs, tripoli and white diamond compounds, and carnauba wax.

823903 \$97.50



PINNACLE® Cryogenic Turning Tools

Cryogenically treatment uses sub-zero temperatures, down to -300° F, to modify the micro-structure of the steel into a more uniform grain structure that allows you to hone to a fine edge that is more durable and more resistant to wear. Cryogenically treated tools stay sharp two to three times longer than standard M-2 High Speed Steel tools! Each tool is mounted in a European ash wood handle. Overall tool lengths range from 17" to 23".

- 149350 1/4" spindle gouge \$45.99
- 148785 3/8" spindle gouge \$46.50
- 148784 1/2" spindle gouge \$58.50
- 149347 1/4" bowl gouge \$66.99
- 148782 3/8" fingernail bowl gouge \$69.99
- 148781 1/2" fingernail bowl gouge \$84.99
- 148783 3/4" roughing gouge \$84.99
- 151210 1 1/4" roughing gouge \$105.99
- 149349 1/2" round nose scraper \$54.99
- 148787 1" round nose scraper \$64.99
- 151212 1" oval skew chisel \$69.99
- 148788 3/4" skew chisel \$62.50
- 148789 3/16" diamond parting tool \$69.99
- 149346 bowl finish scraper \$104.99
- 151330 pepper mill tool \$54.99

Spindle Turning Set contains 3/8" spindle gouge, 3/4" roughing gouge, and 3/16" diamond parting tool.
149020 **save over individual tools** \$154.97

Bowl Turning Set contains 3/8" fingernail bowl gouge, 1" round nose scraper, and 3/16" diamond parting tool.
149021 **save over individual tools** \$159.97

Turner's Set of 5 Tools contains the tools necessary for most projects. Includes 3/8" spindle gouge, 3/8" fingernail bowl gouge, 3/4" roughing gouge, 3/4" skew chisel, and 3/16" diamond parting tool.
149022 **save over individual tools** \$314.99



CROWN David Ellsworth Signature 3/8" Gouge

Designed with a parabolic flute and a very specific tip shape by David Ellsworth, this is the most versatile 3/8" bowl gouge on the market. It will perform huge roughing cuts and delicate finish cuts on both the inside and outside of open bowls and hollow forms. Honing required before use. Blade length is 9 1/16", handle length 16 1/16", overall length 25 3/4".

151209 \$94.99



Crown Pro-PM David Ellsworth Signature 1/2" Bowl Gouge

This 1/2", 13-mm Ellsworth Gouge is made from an advanced Powder Metal, to give the tool a cutting edge which lasts up to four or five times longer than a High Speed Steel tool. Hardened to between 66° and 68° Rockwell for superior wear resistance, excellent grindability, superior toughness, a high working hardness and a high retention of hardness. 16", 406-mm Black Ash Handle.

145092 \$139.99



Crown Skewchigouge

Designed by English turner Allan Beecham, this tool will work as a skew chisel and gouge with equal ease. Virtually catch-proof, this amazing tool has become one of our favorites for any spindle work. 7 1/2" blade, 17" overall with stained beech handle. Honing required before use.

140474 \$44.75



SORBY TurnMaster Plus 5-Piece Turning Set

Woodcraft has partnered with Robert Sorby to assemble the ultimate turning set for any skill level, from the beginner to the advanced turner. The TurnMaster Plus Set includes a handled TurnMaster, 3/4" (19mm) Roughing Gouge, 1/8" (3mm) Parting Tool, three interchangeable Carbide Cutter Heads (square, round, diamond) that can be rotated to provide a sharp cutting edge when needed, and a Flat Credit Card Diamond File.

The TurnMaster is a versatile system that combines a flat underside for added stability and control and a patented lock-tight head that can be set to three positions for shear, flat or traditional scraping actions - features that help reduce resistance from the natural grain of the wood for a superior finish.

160155 \$299.99



SORBY Sovereign 6-Piece Turning Tool Boxed Set

Carefully designed by Robert Sorby's product management team, this set will appeal to beginners and the more experienced woodturner alike. Sovereign enthusiasts will already be aware of the flexibility of the system's handles, but those new to Sovereign will find this interchangeable system allows for quick and easy changes from blade to blade. Sorby has provided an economical and imaginative addition to this theme with the introduction of the 4" handle extension. Using this handy addition, the turner can quickly and easily extend the 12" handle into the popular 16" version. This versatility allows for comfortable close-up work while providing the resourceful extension for larger projects that may call for greater control. Set contains one each of the following: 843 Spindle Roughing Gouge 3/4", 840 Spindle Gouge 3/8", 842 Bowl Gouge 3/8", 810 Standard Skew Chisel 3/4", 830 Standard Parting Tool 1/8", 820 Round Nosed Scraper 1/2", SOV-12 Sovereign 12" Handle, SOV-EXT Sovereign 4" Extension, DSCC 600 Diamond Honing Card, RSDVDSO Focus On Starting Out Woodturning with Robert Sorby DVD, SOV-C10 3/8" Collet to fit 3/8" tools, SOV-C13 Collet suitable for 1/2" shank tools, SOV-CT Collet to fit flat tang tools, and SVO-TC Sovereign Threaded Coupler.

160769 **NEW LOWER PRICE! \$319.99**

SORBY Sovereign Deluxe Spiralling & Texturing Tool Boxed Set

This Sorby Sovereign Deluxe Spiralling & Texturing Tool Set is an absolute must for decorative woodturning. Featuring the full-sized and modular micro systems, this set of tools with varied cutters will deliver a multitude of decorative shapes and patterns on both large and small projects. Sovereign enthusiasts will already be aware of the flexibility of the system's handles, but those new to Sovereign will find this interchangeable system allows for quick and easy changes from blade to blade. Sorby has provided an economical and imaginative addition to this theme with the introduction of the 4" handle extension. Using this handy addition, the turner can quickly and easily extend the 12" handle into the popular 16" version. This versatility allows for comfortable closeup work while providing the resourceful extension for larger projects that may call for greater control. Set contains one each of the following: 330S Unhandled Spiralling System, 350/0 Texturing Cutter, 350/2 Cutter at 2mm pitch, 350/04 Cutter at 4mm pitch, 350/06 Cutter at 6mm pitch, 370/0 Unhandled Modular Micro Spiralling Tool, 370/01 Fine Spiral Cutter, 370/02 Medium Spiral Cutter, 370/03 Texturing Cutter, Sovereign 12" Handle with Softex grip, Sovereign 4" extension with Softex grip, SOV-C13 suitable for 1/2" shanks, DS 600 Diamond Honing Stone 1" x 3" (25mm x 75mm) x 1.5mm-thick in 600 grit, SOV-TC Sovereign Threaded Coupler, RSDVDDT Focus on Decorative Techniques Parts 1 and 2 with Robert Sorby DVD featuring woodturning wizard Nick Agar.

160770 **NEW LOWER PRICE! \$349.99**

COUNT ON US FROM START TO FINISH™

Woodturning



Double-Face Turning Tape

This super-strong, double-sided adhesive tape is the quickest way to secure bowl blanks, and other pieces under 10" diameter on faceplates. All stock must be dry and milled flat for bonding. Oil-resistant, cloth-backed tape is available in two widths.

- 15D25 1" x 36 yds.\$25.25
- 15D26 2" x 36 yds.\$49.50

WoodRiver® Spindle Steady Rest

Used to prevent whip and vibration in long or thin spindles while turning, this heavy cast iron Steady Rest features three adjustable ball bearing guides with a maximum capacity of 3". The Steady comes with two spacer blocks which allow it to be used on lathes with 12", 14", or 16" swings.



- 145095 \$54.99

Zero Zero Center Finder

Quickly, easily, and accurately determines center for round or square stock up to 8" in diameter and hexagons up to 5 3/4" in diameter. Place the plastic center finder over the end of the piece, scribe a line, rotate the centerfinder about 90° and scribe a second line. The intersecting lines define the workpiece center!



- 02J14 \$9.49



The Bullseye Woodturner's Center Finder
Templates make tasks much easier, and this one is no exception. Made from durable 1/8" acrylic, with circles marked at 1/4" increments, The Bullseye makes finding the most desirable turning area in irregular shapes quick and simple. Position the template on the wood, select the position that allows you to utilize the best figure and yield, and then, using an awl in the center hole, scribe a circle on the wood with a pen or pencil. Defects are easily avoided, or "character" areas can easily be included. Template will have a maximum yield of 10".

- 846243 \$19.99

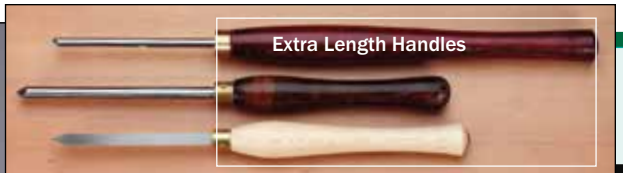

WoodRiver® Turning Tools

Laser Engraving Available

These high quality turning tools are designed to meet the needs of any skill level turner, from beginner to demanding professional. The high speed steel blades are hardened to Rc 62-64 and set in extra long 16" hardwood handles with brass ferrules. The extra length of the handles allows greater control and comfort for those long turning sessions. The HSS blades stay sharp up to six times longer than carbon steel. Available exclusively at Woodcraft, these tools represent great value and quality. Honing required before use.



- | | | | |
|---|---------|--|----------|
| 145904 3/8" spindle gouge | \$34.50 | 145907 1" oval skew chisel..... | \$51.99 |
| 145905 1/2" spindle gouge | \$46.50 | 146229 1/2" round nose scraper..... | \$44.99 |
| 145906 5/8" roughing gouge..... | \$52.50 | 146230 3/4" round nose scraper..... | \$52.99 |
| 146225 3/4" roughing gouge..... | \$57.99 | 146226 3/4" curved scraper..... | \$49.99 |
| 145911 1/4" fingernail bowl gouge | \$45.50 | 145908 1" square nose scraper..... | \$68.50 |
| 145912 3/8" fingernail bowl gouge | \$57.99 | 146227 1 1/2" lt. cut, H.D. bowl scraper | \$112.50 |
| 150492 1/2" fingernail bowl gouge | \$60.99 | 146233 1/8" diamond parting..... | \$46.50 |
| 146174 1/2" bowl gouge..... | \$64.50 | 145909 3/16" diamond parting tool | \$50.99 |

Turning Tool Sets feature the same high quality HSS blades as the individual tools. 6 3/4" blades are set in 16" hardwood handles with brass ferrules. Honing required before use.

Beginner's Turning Set contains 3/8" spindle gouge, 3/4" roughing gouge, 1/2" oval skew chisel, 1/2" round nose scraper, and 1/4" bowl gouge.

- 145913 \$184.99

Turner's Set of 8 contains all the tools necessary for most turning projects. Set contains 1/4" spindle gouge, 1/2" spindle gouge, 3/4" roughing gouge, 1" oval skew chisel, 1" square nose scraper, 1" round nose scraper, 3/16" diamond parting tool, and 3/8" bowl gouge.

- 145914 \$309.99



SORBY TurnMaster

The Sorby TurnMaster is the first tool of its kind, a combination of three cutting edge technologies built into one flexible system. The TurnMaster offers woodturners a choice of tungsten carbide, titanium nitride or high-speed steel cutters that are interchangeable on one tool. With an extensive range of cutters, the TurnMaster is a versatile system that features a flat underside for added stability and control. When paired with the patented lock-tight head, which can be set to three positions for shear, flat or traditional scraping actions, it helps reduce

resistance from the natural grain of the wood, allowing for a superior finish.

- 154659 (A) unhandled \$134.99
- 154660 (B) handled \$147.99
- 154661 head \$31.99
- 154662 (C) round carbide cutter.....\$22.99
- 154663 (D) square carbide cutter.....\$23.25
- 154664 (E) detail carbide cutter\$22.99
- 154665 round HSS cutter.....\$16.50
- 154667 square HSS cutter.....\$16.50
- 154668 (F) french curve HSS cutter.....\$16.99
- 154671 (G) mushroom HSS cutter.....\$16.99
- 154672 (H) round TiN cutter.....\$20.99
- 154711 tip sharpening holder.....\$14.99

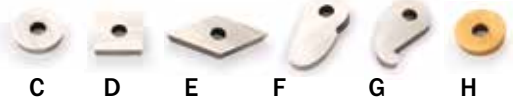

Modular System Saves You Money!



PINNACLE® Lathe Tool Rest System

Woodcraft tool rests are modular in design, and permit you to use your rests on more than one lathe. The solid steel bowl rests provide a stable curve for turning and a flat top for vibration-free scraping. Use the small bowl rest for bowls up to 7" in diameter and the large for up to approximately

14". The "S" bowl rest is 14" long with a 5" diameter bend on one end and an 8" diameter bend on the other. Select the proper diameter post for your lathe and a tool rest in a length or shape to meet your needs. Posts screw into rests and can easily be removed and attached to a different accessory.

- 140456 (A) small bowl rest.....\$27.50
- 140457 (B) large bowl rest.....\$39.99
- 145950 (C) "S" bowl rest.....\$49.99
- 123585 5/8" dia. post, 3.5" long.....\$16.99
- 124186 3/4" dia. post, 3.5" long.....\$16.99
- 123584 7/8" dia. post, 3.5" long.....\$16.99
- 141931 1" dia. post, 3.5" long.....\$16.99
- 123583 (D) 1" dia. post, 5" long.....\$22.50



SORBY HSS Turning Tool Set

Includes the 8 basic tools you'll need for spindle and bowl turning. These HSS tools will keep a sharpened edge about six times longer than carbon steel, and resist "blued" softening from overheating during grinding or from heavy turning. Ash handles offer firm hand control during use and brass ferrules prevent wood splitting from tool pressure. Overall lengths 17" to 21".

14J41*	1/4" spindle gouge	\$43.99
06014*	1/4" parting tool	\$57.50
06031*	3/8" bowl gouge	\$80.99
06021*	1/2" spindle gouge	\$55.99
06034**	1/2" round nose	\$55.99
06011*	3/4" roughing gouge	\$80.99
06024*	3/4" skew	\$63.50
06041	1" square nose	\$74.99
11L40	set of 8 Save!	\$454.99

Beginner's Turning Set will get you started right! Contains the 5 basic spindle turning tools indicated by (*) above. Superior tools that will form the heart of any turning tool collection.

06030 set of 5 Save!\$253.99

Intermediate Turning Set is designed for both spindle and bowl work. Contains the 6 tools indicated by (*) above and below.

146162 set of 6 Save!\$329.99

Additional Styles provide extra versatility for bowl and spindle work. Ash handles.

14P41*	1/8" parting tool	\$50.99
06081	3/16" diamond parting	\$87.99
06051	1/4" bowl gouge	\$65.99
06061*	3/8" spindle gouge	\$44.99
06054	1/2" bowl gouge	\$102.50
14052	1/2" oval skew	\$55.99
06064	3/4" spindle gouge	\$75.99
06071*	3/4" oval skew	\$61.99
06074	1" oval skew	\$74.99
06044	1 1/4" roughing gouge	\$114.99
14P42	3/8" beading & parting	\$55.99



SORBY Fingernail Profile Gouges

The "fingernail" grind has been a popular edge with woodturners because it is easy to use and control, plus it's extremely versatile. These new fingernail gouges feature an easy to use, medium grind, with wing tips that have been ground back so the tool does not "catch" on the work piece. With these tools, pull and push cuts, delicate shear cuts, or even full profile cuts can be made with ease. An added advantage of the medium grind is that it lends itself to easy modification, allowing you to create profiles specifically suited to your turning requirements. Overall length 16 1/2".

126941 (A) 3/8" spindle gouge, shown \$44.99

126942 (A) 1/2" spindle gouge \$56.99

126943 (B) 3/8" bowl gouge, shown \$80.99

126944 (B) 1/2" bowl gouge\$98.99

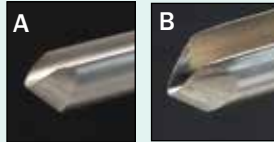

HSS Parting Tools

Are ground with a unique hollow ground edge that forms a pair of cutting spurs on each side of bevel edge. These spurs score cross grain fibers and shear end grain leaving a smooth surface. Blades are 6 1/2" long, handle length 11 1/2".

124054 1/16" thick blade\$73.99



Bedan Tool

A large 3/8" parting and beading tool with unique, ground tapered sides and a top cutting edge. Great for parting into faceplate work.

06012 \$65.99



SORBY Box & Bowl Scrapers

These new shapes are the perfect width for smaller bowls and boxes, yet still thick enough to handle serious turning without chatter. Both are 3/4" wide, 16" long, with 10" ash handles.

Roundnose Scraper. A curved end profile makes this tool excellent for creating, smoothing, or blending curved surfaces on bowls, spindles or round bottom box work. Heavy enough for aggressive shaping, yet small enough for sensitive refining cuts.

126954 (A) \$63.50

Side-Cut Scraper. The cutting profile of this scraper makes it ideal for cutting the parallel side walls of end grain boxes. The small radiused point at the bottom corner of the scraper creates a smooth transition from a side wall to a flat bottom.

126955 (B) \$62.99

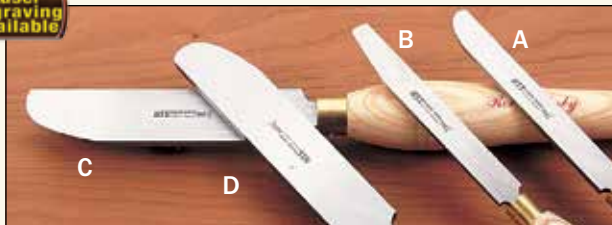

Heavy-Duty Bowl Scrapers. First introduced by master craftsman Richard Raffan, these shapes have been found to be most efficient in producing the final surfaces on bowls. The curved tips with elongated side edges can clean up rough, irregular cuts left by gouges, and cut a more pleasing curved shape too. Available in curved left and curved right styles. Blades are 7" long x 1 1/2" wide x 3/8" thick with 14" ash handles.

06092 (C) left scraper\$133.99

06093 (D) right scraper\$131.99



SORBY Extra Heavy-Duty Scrapers

A Woodcraft Exclusive, these scrapers are a full 1/2" thick to help eliminate chatter. Unlike most heavy-duty scrapers, which are too wide to make tight radius turns or to be used in narrow turnings, these scrapers are sized to work in most turning situations. All feature 7" long blades and 14" Ash handles.

145700 1" square nose\$99.99

145701 1" bowl\$112.50

145702 1" round nose\$112.50

145703 1/2" round nose\$75.99



SORBY Hollow Masters

Features a flat bottom for increased stability and control. The 1/4" wide HSS cutter can be swiveled to allow the cutter to reach otherwise inaccessible areas inside hollow forms. The included 1" round scraper cutter can be mounted in place of the hollowing cutter for final inside smoothing. Full-sized model is 24" long with an 8" reach, mid-sized is 18 1/2" with a 6" reach.

820045 full-sized\$93.99

831862 mid-sized\$79.99



SORBY Beading Tools

You don't have to be an expert to turn perfect beads. This specially ground set of High Speed Steel scrapers will shape beads from 1/8" to 3/8" with absolute consistency each time you use them. Their design enables the forming of a single bead, or a line of beads for really ornate projects. For spindle and bowl work they will add the finest touch of decoration to your creations. 6 1/2" ash handles, blade lengths 4 1/2".

14Y53 1/8"\$35.50

14Y54 3/16"\$35.99

14Y55 1/4"\$42.50

14Y56 5/16"\$42.99

14Y57 3/8"\$41.99

BEALL Spindle Taps

Now you can make all the glue face plates and jam chucks you want without ever having to mount blocks on your metal faceplates again! These taps are machined in lathe spindle sizes so that after you have drilled and tapped a wooded block, you simply mount the block directly onto your lathe. The tapped block can then be put to use in a special faceplate, vacuum fixture or other mounting assembly. Instructions included.

147816 1" x 8 TPI\$17.99

147817 1 1/4" x 8 TPI\$27.99





The beauty of this revolutionary turning system is the uniquely designed carbide cutters. Say goodbye to sharpening because these cutters add up to 20 hours of additional turning time over conventional tools. Once dulled, simply change the cutter. Secondly, the cutters are designed so that you don't have to "find the bevel" when turning. Simply hold each tool flat and level and advance the tool slowly into the work piece and begin cutting straight in or sweep the cutter in any direction.

THE WOODTURNING SYSTEM™



Easy Turning System™

Each tool model is precision machined for its cutter shape, and each shape allows you to cut many different features on both bowls and spindles.

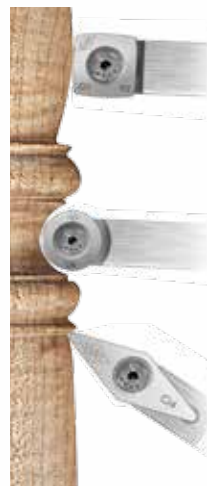

Easy Rougher®

The square shaped carbide cutters are perfect for removing bulk material and smoothing the outside curves of any project.

Easy Finisher®

The round carbide cutters are primarily designed for shaping cuts on the inside curves of bowls and spindles.

Easy Detailer®

The diamond shaped carbide cutters are designed for putting the final details on your project such as small beads and coves on both spindles and bowls.

The Pro Series Easy Rougher



Easy Hollower #1®

Easy Hollower #2®

Easy Hollower #3®

Easy Hollowing System™



Easy Hollower #1®

This straight bar is used to remove material from the center of the vessel and can safely reach 4 1/2" past the tool rest. Try this versatile tool on bowls, coves and pens too.

Easy Hollower #2®

This tool is built with a slight curve for hollowing the beginning of the curved portion of the vessel.

Easy Hollower #3®

Made with a much greater curve, this makes hollowing through the curve up to the lip of the opening an easy task.

Easy Turning Tools™

Mid-Size Tools Shown

Mini Turning Tools | For pens, goblets, wine stoppers and small bowls. Handle 12", Tool bar 3/8" x 4", Max Reach 2", Overall Length 16".

- 845506 Mini Easy Rougher®.....\$89.99
- 845746 Mini Easy Finisher®.....\$89.99
- 150886 Mini Easy Detailer®.....\$89.99

Mid-Size Turning Tools | Same cutters as Mini tools, but the longer handles and tool bars allow you to expand your project size. Handle 14", Tool bar 3/8" x 7", Max Reach 3", Overall Length 21".

- 149928 Mid-Size Easy Rougher®.....\$119.99
- 151018 Mid-Size Easy Finisher®.....\$119.99
- 151019 Mid-Size Easy Detailer®.....\$119.99

Full-Size Turning Tools | Larger cutters, tool bars and handles. Great for large spindle and bowl work. Handle: 16", Tool bar 1/2" x 8.5", Max Reach 4", Overall Length 24.5".

- 149926 Full-Size Easy Rougher®.....\$129.99
- 149927 Full-Size Easy Finisher®.....\$129.99
- 151020 Full-Size Easy Detailer®.....\$129.99

Pro Turning Tools | Premium 20" American Hickory handle for all day at the lathe. Handle 20", Tool bar 1/2" x 8.5", Max Reach 4", Overall Length 28.5".

- 160156 Pro Easy Rougher®.....\$139.99

See next page for replacement cutters

Easy Hollowing Tools™

The Hollowed Form has traditionally been reserved for only the most experienced turners. Now the patented design of the Easy Hollowers® make hollowing and undercutting bowl rims easy and fun for everyone!

Just like the Easy Turning Tools, you only need to hold these Easy Hollowing tools flat on the tool rest to properly turn a hollow form.

Mid-Size Hollowing Tools | For projects up to 4" diameter. Handle 14", Tool bar #1 1/2" x 8 1/2", Overall Length 22 1/2", Tool bar #2 and #3 3/8" x 3/4" x 7 1/2", Overall Length 21 1/2".

- 153522 Mid-Size Easy Hollower #1.....\$129.99
- 153523 Mid-Size Easy Hollower #2.....\$139.99
- 153524 Mid-Size Easy Hollower #3.....\$139.99

Full-Size | For projects up to 6" diameter. Handle 16", Tool bar 1/2" x 1" x 9 1/2", Overall Length 25 1/2".

- 151267 Full-Size Easy Hollower #3.....\$149.99

EASY START Rougher

EASY START Finisher

EASY START Detailer



Easy Start Tools™

These great new tools offer the same premium, razor sharp Genuine EWT Carbide Cutters as other Easy Wood Tools but just in a smaller and more economical version because of their black oxide tool bars and smaller handles. They are the perfect choice for beginners and all skill levels that like to turn smaller projects such as pens, goblets, wine stoppers, small bowls, and other smaller projects. Still 100% made in America and have Easy Wood Tools' unconditional money back guarantee.

Handle 9", Tool Bar: 3/8" x 3.5"
Max. Reach: 2" Overall Length: 12.5"

- 154714 Easy Start Rougher.....\$59.99
- 154715 Easy Start Finisher.....\$59.99
- 158511 Easy Start Detailer.....\$59.99

Easy Parting Tools™

1/8" Easy Parting Tool™

The easiest, safest, cleanest cutting parting tool you will ever use. With perfect geometries built right into the replaceable cutter, you never need to worry with all the fuss of sharpening.



FREE Extra Pil Cutter with tool purchase

Exclusive Features

First ever replaceable carbide insert parting tool for woodturners.

Used flat and level like all Easy Wood Tools (you can also rub the bevel if you wish).

Genuine EWT Carbide Cutters cut wood much cleaner and stays sharp longer than HSS tools.

No uncomfortable sharp edges on the tool bar.

1/8" Easy Parting Tool | Handle 14", Cut width 1/8", Blade Length 3/32" x 3", Tool bar 6", Overall Length 20", Max Part off diameter 4"

- 159328 1/8" Easy Parting Tool.....\$119.99

Using the included Flex Key for cutter changing

FREE Extra Pil Cutter with tool purchase



Cutter Removal
A slight rotation of the Flex Key moves the cutter forward unlocking it for removal.

Cutter Installation
Rotate the Flex Key until the end of its handle flexes about 1/4" and the cutter will be correctly sealed in the pocket.



Turning Accessories

Genuine EWT Carbide Cutters™

After many hours of turning, rotate your cutter to a fresh edge, and then replace your Genuine EWT Carbide Cutter as needed, so there's no sharpening ever! The sharpest edge makes the smoothest cut, so keep a spare cutter around for the last pass.

The Easy Roughers can be equipped with several cutter choices. Select a Square cutter when you need a square shoulder cut such as a tenon. The R4 cutter is the best choice for heavy cuts. The R2 cutter is great for final passes and making pens from start to finish.

Tool Application

Easy Finishers Full-Size and Pro	Ci0	
Easy Roughers Full-Size and Pro	Ci1-SQ	
	Ci1-R4	
	Ci1-R2	
Easy Roughers Easy Start / Mini / Mid	Ci2-SQ	
	Ci2-R2	
Easy Finishers Mini/Mid Easy Hollowers Full/Pro	Ci3	
Easy Finishers Easy Start / Mini / Mid Easy Hollowers Full/Pro	Ci4	
Easy Hollowers Mid-Size	Ci5	
1/8" Easy Parting Tool Mid-Size	Pi1	

Easy Wood Tools manufactures all of their Carbide Cutters right here in the USA to insure quality.

- 149947 Ci0 | Rnd. Carbide Cutter \$17.99
- 149930 Ci1-SQ | Sq. Carbide Cutter.....\$14.99
- 149932 Ci1-R4 | 4" Radius Carb. Cutter \$14.99
- 149931 Ci1-R2 | 2" Radius Carb. Cutter...\$14.99
- 149933 Ci2-SQ | Square Carb. Cutter\$13.99
- 151021 Ci2-R2 | 2" Radius Carb. Cutter \$14.99
- 845747 Ci3 | Round Carbide Cutter\$16.99
- 150887 Ci4 | Diam. Shape Carb. Cutter \$18.99
- 153585 Ci5 | Round Carbide Cutter\$16.99
- 159346 Pi1 | 1/8" Wide Carbide Cutter\$14.99

Chip Deflectors

Easy Wood Tools Lexan® Chip Deflectors easily mount right on your tool to keep the shavings off of you and on the floor where they belong.



- 151022 3/8" Lexan Chip Deflector\$24.99
- 149948 1/2" Lexan Chip Deflector.....\$24.99

Aluminum Faceplates

Easy Wood Tools Faceplates are laser etched with their thread size so you always grab the right one. The larger screw holes and shorter overall length make these rust-free, anodized faceplates a great addition to your lathe.



Have a faceplate on hand for every project size.

- 151012 1" - 8 tpi x 2" Diameter\$21.99
- 151013 1" - 8 tpi x 3" Diameter\$26.99
- 151014 1" - 8 tpi x 4" Diameter\$28.99
- 151015 1 1/4" x 8 tpi x 2 1/2" Diameter.....\$25.99
- 151016 1 1/4" x 8 tpi x 3 1/2" Diameter.....\$27.99
- 151017 1 1/4" x 8 tpi x 4 1/2" Diameter.....\$34.99

WoodRiver®

Turning Chuck

The self-centering 4-jaw chuck features a wide range of jaw movement, quick action and a powerful grip in either expansion or contraction modes. Jaws will expand and grip in a 2"-3" dovetailed recess in the base of your turning. Simply rotate the chuck's outer ring in the opposite direction to firmly hold round stock between 1 5/8" and 2 3/4" or square billets 1 1/8" to 2 1/8" in size. No disassembly or accessories are required to use the accompanying screw chuck which has a 1 1/8" long right hand thread. Chuck body is chrome-plated to protect against corrosion while the jaws are anodized black. Comes complete with screw center, locking levers, T-handled hex wrench for jaw screws and 8 extra jaw screws, in a plastic fitted storage case.

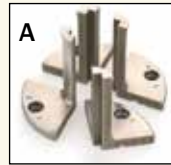

- 146800 3/4" x 16 TPI.....\$99.99
- 146801 1" x 8 TPI.....\$99.99
- 146802 1 1/4" x 8 TPI.....\$99.99

WoodRiver® Pen Jaws convert your WoodRiver® chuck into a fast, accurate pen drilling machine. These jaws provide you with a solid grip for all pen blank sizes and are perfect for squaring up pen blank ends.

- 159918 (A)\$36.99

Threaded Inserts are available for those who want to use the same chuck on lathes with different thread patterns. Inserts compatible with WoodRiver® Turning Chuck only.

- 146797 3/4" x 16 TPI insert\$7.99
- 146798 1" x 8 TPI insert\$7.99
- 146799 1 1/4" x 8 TPI insert\$7.99

#1 Jaws for smaller work. Holds stock from 3/8" to 1 3/8" inside and 1 1/16" to 2 1/16" outside. Jaw length is 1".

- 146804\$24.99

#3 Jaws for larger bowls and platters. Holds stock from 3/4" to 4 1/4" inside and 3 13/16" to 4 13/16" outside.

- 146805\$37.99

15M94 8 extra stops & screws.....\$14.99

Large Flat Jaws make it easy to finish the bottom of plates and bowls. Grips outer edge of stock from 1 7/8" to 8" in diameter.

- 146806\$49.99

Extra Jaw Screws, package of 8.

- 146803\$2.69

WoodRiver®

Small Flat

5" Jaws

Small Flat Jaws for the WoodRiver® Turning Chuck make it easy to finish the bottoms of plates and bowls. With 1/2"-tall and 1 1/16"-tall Cole Stops you can safely grip the interior or exterior of your projects with ease. Grip outer edge of stock from 1 7/8" to 4 1/2".

- 159916\$32.50



WoodRiver® Turner's Collet Chuck Set

Collet chucks are preferred by woodturners for holding small pieces for turning because the collets grip tight enough to easily hold your work, but with little or no marring. Our chuck is built to machinist tolerances and uses interchangeable collets to grip round tenons. The collets, which work just like the chuck in your router, grip with even pressure completely around the tenon on your workpiece. Includes eight collets which range from 1/8" to 3/8" and 1/2" to 5/8" by 16ths, collet chuck with #2 Morse taper and chuck wrench in a fitted case.

- 146110\$99.99

WoodRiver®

Extra Long Flat Jaw Stops & Screws

Compatible with WoodRiver® Flat Jaws, these Extra Long Flat Jaw Stops and Screws enable you to grip tall and odd shaped turnings. Two different heights that allow for greater versatility and the triangular shape make the perfect combination for securing almost any shaped turning to your lathe. Package comes with eight 3/4"-tall stops and eight 1 1/2"-tall stops and the appropriate length screws.

- 159917\$27.50

WoodRiver® 60° Cone Live Centers

These heavy-duty ball bearing centers can also be used for holding a workpiece with a hole from 1/8" to 1 1/8" diameter.

- 149168 #2 MT\$25.99
- 149169 #1 MT\$25.99



WoodRiver® Multi Tooth Drive Centers

The multiple drive teeth and spring-loaded center point benefit both novice and experienced turners. The spring-loaded center point holds your workpiece exactly where you want it, then retracts as tailstock pressure is increased. This keeps the point from drifting with the grain or splitting the workpiece. Because the center retracts, less pressure is needed to engage the teeth, especially helpful in hard woods where a traditional center would have to be driven in to engage the spurs. The Insert version is designed to be held in the jaws or most lathe chucks so you can switch back and forth between bowl and spindle work without removing your chuck.

- 149173 1" dia. #2 MT\$26.99
- 149174 5/8" dia. #2 MT\$26.99



ONEWAY Stronghold Chuck Kit

Never again will you feel like you need three hands to tighten your workpiece in a woodturning chuck! Using a unique chuck and key system, the Stronghold allows you to hold your workpiece in one hand and tighten/loosen the chuck jaws with the other! In addition to one-handed key operation, this chuck offers the finest engineering and the most precise machining we have seen. With the capacity to hold a wide range of stock shapes and sizes, this 8-pound geared scroll chuck features a design developed by turning professionals and built to stand up under the most demanding turning operations. The heavy-duty 4 1/2" diameter body helps dampen rough stock turning vibrations while providing a powerful, secure grip. Other features like a nickel-plated scroll body, taper lock bushings for left or right hand use, and profiled "step" jaws for superior gripping of round or square stock all add up to make this the professionals choice. Stronghold kit includes: 1/2" x 1 1/2" RH jumbo wood worm screw; #2 jaw set (grips round stock from 1 3/4" to 3", square stock from 1 3/8" to 3"), and expands into dovetail recesses from 2 1/2" to 4"), operating key, hex screws, T-handle hex wrench, removeable threaded adapter and instruction booklet. Canada.



- 124362** 1" x 8 TPI..... \$299.99
124363 1 1/4" x 8 TPI..... \$299.99

Stronghold Threaded Adapters allow maximum versatility! Each Stronghold Chuck has a removable threaded adapter. By removing your existing adapter, and installing one with a different thread pattern, you can use your Stronghold Chuck on a different lathe!

- 124345** 1" x 8 TPI.....\$30.99
124346 1 1/4" x 8 TPI.....\$30.99

(A) #1 Jaws for holding small work. Grips round or square stock from 1/2" to 2", expands in dovetail recesses from 1 1/8" to 2 5/8".

- 124348** \$51.99

(B) #3 Jaws for bowls, vessels and platters. Designed for strength, these jaws are built to handle "large" turnings. Grips round or square stock from 3 1/2" to

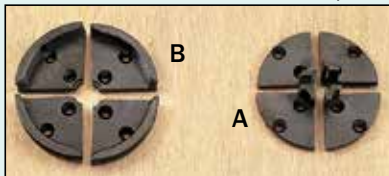

5 1/2" in diameter, or expands into dovetail recesses from 4 1/2" to 6" in diameter.

- 124350** \$55.99

Jumbo Jaws. Designed to re-chuck bowls and plates up to 12" in diameter for complete "bottom finishing". The 8 rubber grippers cushion and hold your workpiece during light finish turning and sanding operations. (Not shown).

- 124351** \$104.99
813763 set of extra rubber grippers.....\$29.99

(B) Step Jaws have three different dovetailed steps for optimum gripping of bowl feet from 1 5/8" to 3 1/4" diameter. Outside expanding dovetail fits a recess 3" to 4" dia. for bowls and platters up to 12".

- 15M92** \$49.99

(C) Spigot Jaw Sets are heavy section jaws with a powerful grip for spigot (tenon) turning. With 30mm (1 1/8") depth and a special serrated tooth form, these jaws really hang on to your workpiece. For work where a long overhang is needed or following into endgrain, these jaws provide superior gripping power.

- 15N81** 35mm..... \$44.99

SuperNova PowerGrip Jaws. For SuperNova, SuperNova² and Titan Chucks.

- 128178** \$64.99

NOVA Pin Jaw Set

- 123548** \$54.99

NOVA 75mm Bowl Jaw Set

- 146082** \$59.99

NOVA 75mm Bowl Jaw Set

- 15M83** 10".....\$69.99

- 144857** 8"..... \$54.99

NOVA Pen Jaw Set

- 158719**\$39.99

(D) Nova Chuck Spur Drive Center. This four-spur center was designed to be secured in the chuck by the standard 50 mm jaws.

- 111190** \$22.50

NOVA RH Inserts

The insert has different lathe spindle thread sizes internally to screw into the back of your Nova chucks, then lock it onto the spindle of the headstock reverse turning. Fits all Nova chucks except Compac.

- 153008** 1" x 8 TPI RH w/ set screw.....\$25.99

- 15M80** 5/4" plain #1.....\$19.99

- 15M78** 3/4" x 16 TPI #2.....\$19.99

- 126601** 1 1/4" x 8 TPI #4.....\$19.99



TEKNATOOL SuperNova2 Chuck

The newest evolution of the classic Nova Chuck is finally available - the SuperNova2! Its nickel plated body is made from high grade K1045 steel machined to allow closer tolerances. Its patented gearing system delivers incredible gripping power and is over a third faster than the original SuperNova. With SuperNova2 gripping power you'll find yourself turning longer, more delicate stems. Large, rough and uneven work that you couldn't handle before can now be turned with greater security. The SuperNova2 requires only one hand to operate using a ball nosed Allen key with a large easy grip handle (included). It's quick to tighten and requires much less effort. The ball nose allows the handle to operate at an angle while tightening the chuck. The SuperNova2 has a fully sealed heavy duty backing plate made from Duracon 25 composite which is reinforced with stranded glass fiber. Backing plate design incorporates a 24 division index for future indexing accessories. All of the original Nova Chuck accessories, jaws and inserts are 100% compatible with the SuperNova2! The unique and user friendly features of this chuck prove it was designed by and for woodturners. Diameter of chuck is 3 7/8", depth is 3 3/8", weight 5 1/2 lb. Includes 50mm jaw set, T-bar, Allen wrenches, woodworm screw and manual. Requires a threaded body insert to fit your lathe



NOVA Live Center System

- Hollow center design accepts 5/16" shell Auger for lamp stand boring.
 - Threaded center has a 5/16" bolt so it can act as an arbor to mount a variety of projects.
 - Miniature reverse cone function to "centerless" mount miniature round turnings up to 12mm
 - Fits #2 Morse Tapers
- 148539** \$73.50

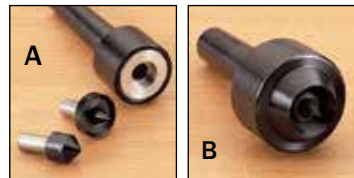

Value-Priced Live Tail Centers

These value-priced centers have removable centers: #1 Morse Taper comes with a point and a cup with point; #2 comes with a cup with a removable point. Both feature smooth ball bearings for long life.

- 141059(A)** #1 MT value center.....\$18.99

- 141060(B)** #2 MT value center.....\$19.25

WoodRiver® Turner's Sanding Pack

This convenient dispenser is loaded with five 1" x 20' rolls of cloth-backed aluminum oxide abrasives for spindle, pen, or any turning. Each dispenser pack contains rolls of 150, 240, 320, 400, and 600 grit abrasives. Just pull out the length of abrasive strip you need and tear it off on the metal cutting strip on the edge of the dispenser.

- 148558** sanding pack\$24.99

- 148559** repl. roll 150 grit\$5.50

- 148560** repl. roll 240 grit\$5.50

- 148561** repl. roll 320 grit\$5.50

- 148562** repl. roll 400 grit\$5.50

- 148563** repl. roll 600 grit\$5.50



NOVA Accessories

Nova jaw sets add even greater versatility to the Nova Midi, SuperNova², and Nova Titan chucks.

Each set is precision-machined from a high quality solid steel billet and comes with an easy-to-read instruction manual. Choose a set to match your project! The 25mm to 130mm Jaw Sets are all similar to "A" in the photo.

25mm Jaw Set substitutes for the standard 50mm jaws for use on small work with 3/8"-1 1/4" spigots, as a type of pin chuck with 1" capacity, for expanding dovetail work on bowls up to 6" diameter or for 1/2"-1" square blanks.

- 15M86** \$44.99

(A) 100mm Jaw Set. Expanding dovetail jaws hold bowls up to 14" diameter, contracting jaws grip spigots and bowl feet up to 3 1/2" diameter or square billets from 2 9/16" to 3 7/8".

- 15M91** \$49.99

130mm Jumbo Jaws for holding large bowls and platters. Primarily designed for work over 16" in diameter up to a maximum of 29 1/2". Jaws will grip spigots from 4.2" to 5" and expand into dovetailed recesses from 4.88" to 5.86". Fits SuperNova2 and Titan chucks only.

- 126358** \$59.99

NOVA G3 Chuck

This is a great little geared-action chuck, with powerful performance for its size and built to the same standards as the SuperNova2 chuck! Designed for mini, midi and smaller lathes up to a 14" diameter swing, this chuck's small size and weight minimizes the load on smaller spindles and bearings. The G3 accepts all of Teknatool's accessory jaws, although only those designed for smaller work are recommended. This chuck also includes an automatic jaw safety stop to keep the jaw slides from falling out. Teknatool also makes the jaw slides from iron composite impregnated with copper, which has outstanding qualities as an anti-seize and low-friction agent. Using the standard 50mm jaws (included) this chuck will handle up to 14" diameter bowls and turnings with up to a 6" length spigot. Chuck body is approximately 3 3/8" diameter, depth is 1 3/4" and 3 lbs. on the lathe spindle. Includes chuck body, woodworm screw, 50mm jaws, T-handled chuck key, manual and fasteners. Available without a threaded insert for turners who already own Nova chucks with removable inserts.

- 147016 G3 without threaded insert \$99.99
- 147017 G3 with 1" x 8 TPI \$145.99
- 147018 G3 with 3/4" x 16 TPI \$145.99
- 147019 G3 with 1 1/4" x 8 TPI \$145.99
- 150306 (A) Nova 4-pc. Mini Jaw Set \$114.99

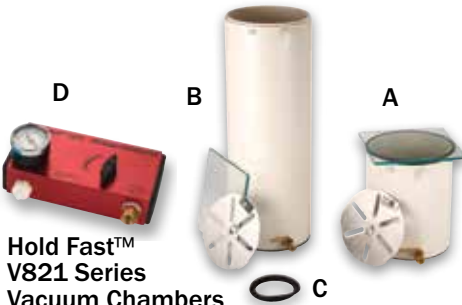
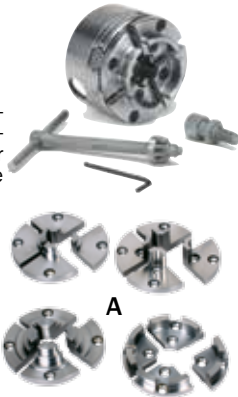

Hold Fast™ V821 Series Vacuum Chambers

Stabilizing wood has never been easier! From TMI Products comes the Hold Fast V821 Series Vacuum Stabilization Chambers that provides the optimum in versatility and economy in wood stabilization. The stabilization process handles all types of woods, including punky and spalted woods, creating solid pieces from what may have been otherwise unusable material. To stabilize the product, a vacuum is used to draw the low viscosity/low odor heat cured stabilizing resin in through the wood, making use of capillary action to create a piece that is easy to turn and polish. Resin can be dyed using any of the Stick Fast powdered dyes to add pops of color to the wood. An improved vacuum generator operating at 25+ in Hg, working with a compressor capable of generating 2 CFM at 70 - 85 PSI, facilitates processing a much greater volume of wood (compressor sold separately).

- 866363 (A) 8" chamber \$96.99
- 162666 (B) 18" chamber \$137.99
- 162667 (C) repl. seal for V821 series \$6.99
- 159883 (D) vacuum generator \$129.99
- 158277 resin/catalyst, quart \$33.99
- 158278 resin/catalyst, gallon \$99.99

CARTER MultiRest™

The Carter MultiRest™ is compatible with lathe swing sizes from mini up to 20" with no additional hardware required. The base of the MultiRest has independently adjustable spacer blocks providing a secure fit on lathe beds with way sizes from 1" to 4 1/2" in width. The unique two-piece design allows the MultiRest to be quickly opened while leaving the base firmly attached to the lathe bed, providing easy access for mounting, sanding, and demounting turnings. Another benefit of the MultiRest is the ability to remove the larger section which allows the smaller section to be used as a bowl rest. The MultiRest is equipped with bearing mounted, non-marring urethane wheels which have a rigid internal ring to prevent sidewall flex, thus providing excellent support.

- 154325 \$359.00

A-LINE-IT Systems

Quickly setup, tune up, and check the accuracy of your shop's tools with these systems. Check table saw blade and fence alignment, arbor and blade run-out, miter slot to blade squareness, arbor/chuck run-out, jointer/planer head to table parallelism, jointer/planer knife alignment, outfeed table alignment; router/shaper spindle run-out, or any other set-up or alignment measurement you desire.

A-LINE-IT Basic Kit is the perfect for hobbyists and small shops. Each kit contains a 3/4" x 3/4" x 5 1/2" dial indicator mounting bar, 3/8" x 3/4" x 6 1/4" miter groove bar with leveling screws and spring plungers for a perfect fit in your miter slot, dial indicator, hardware and hex wrench for assembly, and an instructional DVD.

The A-LINE-IT Deluxe Kit includes all of the above but features an 11" long dial indicator mounting bar instead of the 5 1/2" bar, a planer bar, a precision 1/2" x 3 3/8" pin for drill press and router tests, special spring and arbor nut to test saw blade and arbor run out, 22-piece tip set for the dial indicator to meet any application, instructions and instructional DVD for expert guidance in getting the best performance and accuracy from your woodworking machines.

- 148719 basic kit \$89.99
- 148720 deluxe kit \$154.99



1/2" Keyed Lathe Drill Chucks

While the lathe tailstock is mostly used to support rotating spindles it can also be used as a collet for a drill chuck or live center. Inserted in the tailstock, a drill chuck allows your lathe to work like a small horizontal drill press. Drill chucks hold forstner bits, brad-point bits or twist bits from 1/32" to 1/2". These JT33 keyed chucks can also be used on many drill presses.

- 154751 #1 MT \$42.50
- 154750 #2 MT \$42.50

Deluxe Drive Centers

have sharp spurs for superior bite to help keep even difficult workpieces from tearing out and slipping. The center point is spring loaded so it holds the workpiece in position until the spurs engage, then retracts to prevent splitting your work as it advanced into the spurs.

- 149170 1" dia. #2 MT \$22.99
- 149171 5/8" dia. #2 MT \$22.50
- 149172 5/8" dia. #1 MT \$23.50



Hold Fast™ Pro Pen Turning Kit

Made in the USA, the Hold Fast Pro Pen Turning Kit is precision machined using double bearing construction for heavy-duty use and long life. That's right; you can use this system to turn pens. Install the mandrel driver into your lathe's headstock. Insert the proper mandrel rod into the mandrel driver. Install the pen collet into the live center body, slide the live center over the mandrel rod to the pen bushings, lock down the tailstock, and tighten the quill. The compression of the collet will lock the mandrel rod in place and allow you to turn accurately every time! No more off-center turnings! Kit contains one each of the following: live center body, pen collet insert, #2MT mandrel driver, precision mandrel rod, standard mandrel rod, and set of nonstick CA finishing bushings. And did we mention that the hollow center design makes it capable of accepting a removable cup center or 60° cone to create a premium live center? Accessory cones sold separately.

- 162660 (A) pro pen turning kit \$89.99
- 162661 (B) center insert kit \$29.99
- 162662 repl. pen collet insert \$13.99
- 162663 repl. precision mandrel rod \$5.99
- 162664 repl. standard mandrel rod \$5.99

Steel Compass

Make more accurate scribes or layouts. The tips of these heavy-duty scribes are precision ground for accuracy and finished with black epoxy coating for durability. The 6" compass has 8" scribing capacity, the 8" has 10 1/2" scribing capacity, and the 16" has 22" scribing capacity.

- 148053 6" \$23.99
- 148054 8" \$29.99



WoodRiver® Stainless Steel Center Finding Rules

These WoodRiver® Stainless Steel Center Finding Rules eliminate guesswork, math and the use of dividers. To find center, simply align the rule so the same measurement appears to the left of the "0" mark as appears to the right of the mark. The arrow will point to the exact center. This stainless steel rule is 1 3/4" wide.

- 159459 12" (shown) \$9.99
- 159460 24" \$11.99



Marking & Measuring



STARRETT® 1202F-6

6" Fractional Dial Caliper

This Starrett 1202F Series Fractional Dial Caliper shows measurements as fractions on the yellow outer scale, with 1/64th inch graduations, and decimal measurements on the white inner scale, with 1/100th inch graduations. This caliper provides quick, accurate (to +/- .001") measurement of outside dimensions, inside dimensions, and depth.

160779\$127.50



STARRETT® 6" Steel Rules

These Starrett 6" Steel Rules are made from spring-tempered steel for long life and feature a satin chrome finish and graduations at quick-reading 32nds and 64ths. Each is 3/64" thick and 3/4" wide. (Reverse Side shows)

160776 (decimal equivalents) \$31.99

160777 (letter and number drill sizes).... \$34.99



STARRETT®

Tempered-Steel Reversible-Hook Rules

These Starrett Steel Rules with Inch Graduations feature a satin chrome finish and graduations at 8ths, 16ths and quick-reading 32nds and 64ths, plus a reversible hook.

160778 12" \$58.99

830415 6" \$33.99



STARRETT® 277-6

Toolmakers' Spring-Type

6" Caliper And Divider, With Round Legs

The Starrett 6" Toolmakers' Spring-Type Caliper and Divider with Round Legs and Solid Nut is the finest tool of this type. Designed for woodworkers that require finer adjustment and a better balance, the tool is precision made to Starrett's high standards. It features a hardened fulcrum stud, strong and flexible bowstring, and centrally located leg adjustments to ensure smooth action.

840772 \$74.99

Woodpeckers®

24" Precision Woodworking T-Square

Drawing straight, accurate lines can be challenging when relying on a tape measure and a scrap of wood as a straightedge. Now there's a better way, the new Woodpeckers T-Square. Whether working off a factory-cut edge or not, the Woodpeckers T-Square will help you draw straighter, more accurate parallel lines in less time than you can imagine. In an instant, you can move your pencil from 3" off the edge to 12" and be dead-on without the need of a tape measure. Each Woodpeckers T-Square consists of a precisely machined, laser engraved, aluminum blade that is perfectly fitted to a solid, billet handle with two support lips to prevent tipping and a perfectly machined edge for true squaring.

161105 \$114.99

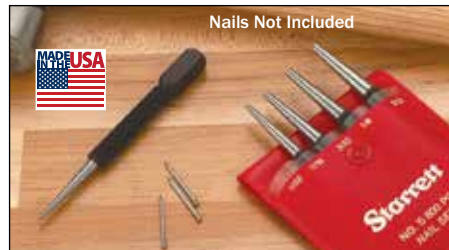

STARRETT® S800PC

Square-Head Nail Set

The Starrett Square-Head Nail Set includes sizes 1/32", 1/16", 3/32", 1/8", and 5/32" in a protective case. Nail set has a knurled grip for secure holding and a large, square-head striking surface.

160844 5-piece set \$67.99

Starrett



STARRETT® 818

Automatic Center Punch

The lightweight Starrett Automatic Center Punch is the perfect tool for accurately spotting the location of a hole. It has an adjustable stroke for easy depth setting and a knurled aluminum handle for a positive grip and easy handling. No hammer required. Length is 5", and diameter is 5/8".

827506 \$39.99



Wixey™ WR 41

8" Digital Protractor/Rule

Wixey's newest addition to its Digital Marking and Measuring line is the 8" Digital Protractor/Rule that can be used to measure angles in any plane. It sets both the miter and bevel angles and is great for project layout and scaling. Features 7" and 400mm high impact polycarbonate precision rules. Auto shutoff for extended battery life. Range of 0° to 360°. Accurate to 0.1°. Battery: type 3.0V CR2032.

161654 \$14.99

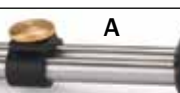

is designed to sever wood fibers, not tear them, so the resulting scribe line is crisp and clean. Additionally, the cutter wheels are oriented

with opposing bevels so the bevel is always on the waste side of a cut. One rod has a cutter at the end for easy marking of a tenon shoulder or mortise depth. Cutters can be retracted into the brass face, together or individually, for storage or for single cutter use. The off center, side-by-side placement of the adjusting rods creates a large reference face and minimizes rolling on your benchtop. Overall length is 7 1/4".

153362 dual marking gauge \$59.99

153363 repl. inside cutter \$5.49

153364 repl. outside cutter \$5.49

154120 (A) shaft clamp \$10.50



Wheel Marking Gauge

This simple single bevel edge wheel scribes a fine line without tearing wood fibers and does not wander with the wood's grain. A precision ground brass shoe glides against the edge of the workpiece, and the knurled brass knob makes inch or metric scaling adjustments quick and easy. As an extra feature, the shaft can be reversed and the tool used as a depth gauge. Overall length is 8 3/8", with a working capacity of about 6 3/4".

153490 \$16.50

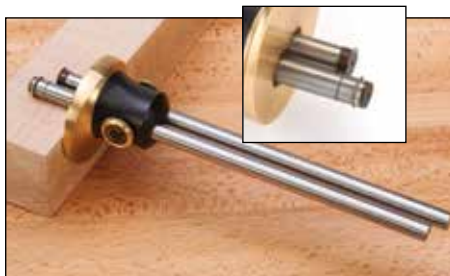

Veritas® Dual Marking Gauge

The Veritas® Dual Wheel Marking Gauge has two independent, adjustable rods that project up to 5 3/4" and have a hardened steel wheel cutter attached. Each cutter has a beveled edge and

Woodpeckers® Aluminum Precision Square

The accuracy of this machined aluminum square is better than .001" over the entire 8" x 12" size. Both the blade and base are machined from a single aluminum block which results in a more accurate square than one using a two-piece blade and base design. The handle and the square are assembled together using two chrome hardened steel pins for rigidity and alignment. The square is anodized for durability, with laser-engraved inch scale markings for general marking and measuring. Includes a custom-fitted wooden MDF case for storage. USA.



- 154067\$119.99
- 159656 851\$79.99
- 159657 641\$59.99



Woodpeckers® Precision Straight Edge Rules

Combines two of the more important measuring and layout tools - a reliable straight edge and an accurate rule. Each inch and fractional marking is laser engraved to a positioning tolerance of .0002". Unlike a common tape measure, you will never question the accuracy of this ruler. Both edges are precision-milled for true parallel and reliable straightness. Comes in a fitted MDF wall-mountable case for safe and convenient storage. USA.

- 154073 24"\$49.99
- 154074 36" (shown)\$59.99



Woodpeckers® Woodworking Rules

The laser-engraved markings are more accurate than printed or stamped scales, they're straighter, heavier and lay flat because of the recess down the center of the bottom surface. Other features include both a standard and a center scale so you don't have to switch rules with edges beveled at 30° so the scales are easy to align with pencil marks. USA.

- 154076 (A) 12" rule\$22.99
- 154077 (B) 24" rule\$32.99
- 154078 (C) 36" rule\$42.99
- 154083 (D) hook stop\$19.99



WoodRiver® Woodworker's Pencil

This unique pencil with extra thick (5.66mm, about 7/32" D x 3 1/8" L) HB round lead is held firmly in place by a four-jaw collet. Unscrew the top to access an internal sharpener. Comes with HB (hard) lead.

- 146807\$16.79
- 146769 4B, soft lead (2)\$1.99
- 146770 HB, hard lead (2)\$1.99
- 147263 colored lead assort.\$5.50



STARRETT® Measuring Tools

Feature unerring American-made precision and durability. Their century-old dedication to producing only the highest quality tools has earned them the well-deserved title of "the world's greatest toolmakers". Measuring tools have working surfaces ground to a demanding $\pm .00001"$. Rules are made of engraved, hardened, premium-quality steel finished with an easy-to-read satin chrome surface.

Combination Squares. Each model features a machine divided, tempered steel rule and precision-ground head with 90° and 45° faces. A hardened scribe and spirit level are included in the 12" and 6" models. All rules are marked with 1/64, 1/32, 1/16, and 1/8 inch graduations. Center & Protractor heads are not included with square (see below).

- 06R12 (A) 12" square only, shown\$108.99
- 06L21 (B) 6" square only\$94.99
- 06R19 (C) 4" square with center head \$132.50

Protractor Head. For 12" square only. Locking protractor featuring a spirit level and double graduations reading 0° - 180°.

- 06R16 (D)\$122.99

Center Heads locate the center point of round or square stock, or layout 45° angles.

- 06L11 (E) for 12" square\$39.99

Extended Length Rule. Expand the capacity of your 12" square by changing to a 24" rule.

- 06R18 (F) 24"\$137.99

Double Squares are as accurate as engineers squares and as adjustable as combination squares. They're the perfect small-size tools for checking or setting 90° angles. Graduated rules are of hardened steel with precision-machined stocks. 6" size includes a spirit level.

- 06E44 (G) 4"\$82.50
- 07F11 (H) 6"\$99.99



Woodpeckers® Precision Triangle Set

Serves as both a square and a 45° miter. The pocket-sized triangle is perfect for squaring the inside of boxes and drawers. Both the 4 1/2" and 6 1/4" triangles in the Woodpeckers Precision Triangle Set are manufactured from anodized aluminum and are guaranteed in perpendicular accuracy to within .001". Both sides are laser engraved with inch markings, graduated in 16ths. The set comes in a fitted MDF wall-mountable case for storage. USA.

- 154069\$64.99

FastCap® AccuScribe PRO

The AccuScribe Pro makes it easy to maintain a consistent scribe offset while remaining parallel to the object surface every time. The non-rocking base provides stability, and the articulating pencil head adjusts to accommodate difficult and awkward scribing applications such as scribing around windows and doors. Also ideal for scribing the trim strip on kitchen cabinets, architectural moldings, tile, countertops, splash guards, and even flooring. Includes an oversized thumb screw, a convenient built-in pencil sharpener, and a removable compass point with its own storage clip.



- 147402\$17.99

Veritas® Dovetail Saddle Markers

Veritas® anodized aluminum markers make quick and accurate work of marking dovetails. The long leg and right angle fold around the edge so a continuous line can be transferred to both sides of the workpiece at the same time. The 1:6 angle is used on softwoods, while the 1:8 angle is better suited for hardwood dovetails. The 14° marker is designed for thinner stock and produces a slightly exaggerated dovetail joint.



- 833750 1:6\$14.99
- 833751 1:8\$14.99
- 153361 14°\$14.99



WoodRiver® Yardstick Compass Points

- Cut And Draw Circles Up To 71" In Diameter
- Attaches To Yardsticks 5/32" Thick x 1 1/8" Wide
- One End Has A Fixed Hardened End Steel Point
- The Other End Has A 4-Jaw Chuck That Can Either Be Used With Lead Or Compass Blade

- 06A51\$10.25
- Metal Ruler Available Separately.

Marking & Measuring

CHAPPELL Universal Squares

Chappell Universal Square & Rule Company was the first to combine a center rule with a square, and now Chappell has introduced a line of center



rule and gauging bench squares for the cabinetmaker, furniture maker and general woodworker. Center rules work great for detail layout when working from center lines, while gauging squares are ideal for intricate layout and also for setting tools to the perfect 90°. Chappell Universal Squares are made from rugged, 13-gauge #304 stainless steel, are deep etched for long life, and are guaranteed to be square within .003. All the squares are in 1/16ths. Made in the USA.

- 158214 9" x 12" center square \$53.99
- 158215 6" x 9" center square \$38.99
- 158216 3" x 4" universal square \$26.99



WoodRiver® Curve Templates

Transfer complex or compound curves from patterns or directly from your work piece. This handy tool eliminates the frustrating "creep" common to most flexible templates ensuring that you get perfect curve reproduction every time.

- 148455 37" template \$45.99
- 148456 107" template \$83.99



INCR Precision Marking Rule

The first stainless steel rule with micro-fine guide holes for marking a fine dot with a sharp pencil or metal scribe. Micro-fine marking holes and slots at every 1/16", 1/32" and 1/64". Instantly mark your position with zero uncertainty, zero parallax and zero eye strain. Flexible structure for working on curved surfaces, ultra thin for ultra precision.

- 125477 6" \$12.99

PINNACLE® Combination Square

One of the most valuable tools in any shop is the combination square. The problem is that most shop combo squares are cheaply made, and inaccurate. Enter the Pinnacle 12" combination square, a Made-in-the-USA tool, with a 12" stainless steel blade that is graduated in 8ths and 16ths on one side and 16ths and 32nds on the other and accurate to within +/- .003" between any two graduations, and +.006/- .004" from 0 to any graduation. The blade graduations are micro-fine etched with the finest grey iron castings for high contrast and the cast-iron heads are coated with a Hammertone Black Powder Coat finish. The square head is accurate to +/- .005" and comes with a level vial and stainless steel scribe tool. Three-piece set

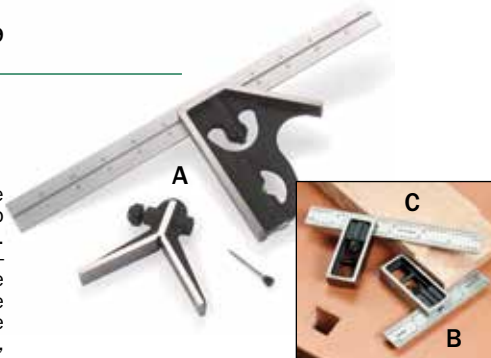

includes 12" blade, square head and center finder in a blow-molded case.

- 149872 (A) 12" combo square 3-pc. set..\$66.99
- 149873 24" blade..... \$62.99
- 04P56 (B) 4" double square.....\$29.50
- 04P57 (C) 6" double square..... \$54.99

WoodRiver® Stainless Steel Cabinetmaker's Rules

These high-quality rulers are also an excellent value. They are made of hardened stainless steel with deeply engraved graduations. The finest graduations are in 64ths and .5mm's. The rear face displays an inch to metric and fraction to decimal conversion table.

- 140655 6" (150mm) \$6.50
- 140656 12" (300mm) \$13.99
- 140659 24" (600mm) \$19.99
- 140657 40" (1000mm) \$29.99
- 140658 Save - set of 4 \$58.50

GRÖZ Engineer's Squares

These all steel, precision squares are handy for setting up table saw blades, jointer fences, and other machine tools where accuracy is a must. All surfaces and edges are ground for straightness and parallelism and the squares are accurate on both inside and outside edges.

- 141013 2" blade \$25.50
- 141014 4" blade \$24.99
- 141015 6" blade \$29.50
- 148041 set of 3 Save! \$69.99



WOODCRAFT Hook Rules

allow exact measurements from ends or edges without struggling to see both ends of your rule at the same time.

- 6" Hook Rule. Rigid, 3/4" wide and .040" thick, with 1/2mm increments one side, 1/32" on the other.
- 128292 \$21.50

WOODCRAFT Rules

High Precision And Reliability For A Lifetime Of Accurate Measuring. These steel rules have been heat-treated and tempered to stand up to rugged use. Finished in a satin chrome so the precise graduations, photochemically etched and black-filled, are easy to read. Made in the U.S.A., these rules meet official Federal specifications for accuracy.

- 6" Pocket Rule. Rigid, 3/4" wide, .040" thick, with 1/2mm increments one side, 1/32" on the other, reads left-to-right and right-to-left. 1/32" end graduations.
- 129207 (A) \$17.99

- 12" Bench Rule. Use this reliable tool for serious bench measurements. 1" wide rigid rule, .040" thick, with 1/32" and 1/64" on one side, 1mm on the other.
- 129208 (B) \$32.50

- 24" Shop Rule. For longer measurements where measurements with a 12" rule might impact accuracy. Rigid, 1 3/16" wide, .040" thick, 1/64" on one side, 1/2 mm on the other.
- 129209 (C) \$49.99

- Woodworker's Ruler Set. Our most popular 6", 12", and 24" rules.
- 129215 set of 3 Save! \$83.50



eTape16 Digital Tape Measure

Simple, reliable and accurate are the best words to describe the new eTape16. The standard 16'-long, 3/4"-wide tape features inch and metric measurements and a large, easy-to-read digital display that offers readouts in 1/16" and 1mm increments. Made from heavy-duty polycarbonate, the eTape converts to feet, inches, and fractions, has an easy on and auto turnoff, and comes with instructions and an ER2032 lithium battery.

- 160117 \$39.99

Koala Tools Ring Ruler™

The Ring Ruler™ is the first size-adjustable, circular ruler. It has been designed to make the drawing and measuring of circles and arcs a much simpler, more efficient experience by eliminating the cumbersome pivot-point system. Not only is the natural feel of expanding and contracting a circular ruler more ergonomic than using a needle compass, it is also quicker, safer and provides the more useful circular metrics of diameter and circumference (arc length). Rule is 19" long; maximum diameter is 6".

- 859222 \$9.99

CROWN Rosewood And Brass Marking Set

We've combined the beauty and reliability of imported rosewood and solid brass with three classic bench tools. Try Squares have blued steel blades triple-pinned to their handles. A 1/8" thick brass rub plate protects inside face for accurate readings. 10 1/2" Bevel with sliding steel blade can be easily secured at any angle by a brass thumb lever. Marking Gauge features an adjusting pull slide for fast layout of mortises. Rosewood post has double steel pins on slide face and a single pin on the reverse face. Rosewood fence has brass wear plates and set knob. Set of 3 includes marking gauge, 10 1/2" sliding bevel, and 6" try square.



Made in England

- 100114 set of 3** \$104.99
- Also available individually
- 14C41** marking gauge \$48.99
- 07F87** 4" sliding bevel..... \$23.25

- 143016** 10 1/2" sliding bevel..... \$38.50
- 14C33** 3" try square..... \$24.50
- 14C15** 4" try square..... \$28.50
- 14C11** 6" try square..... \$32.99
- 14C19** 9" try square..... \$36.50

6" Fractional Digital Caliper

Take accurate digital readings in millimeters, inches or fractions at the touch of the function button. The large, easy-to-read, 1/2" x 1 1/4" LCD screen displays measurements in .0005", .01mm, or 1/64" resolutions. Make inside, outside and depth measurements to 6". Features include auto power off, zero setting at any position, extra battery and case.

- 147828** \$41.50

WIXEY™ Dual Display Fractional Digital Calipers

These are the ONLY fractional calipers available that display both the fraction and the decimal equivalent AT THE SAME TIME! Because other fractional digital calipers round up or down to the nearest fraction, you never know if you are *exactly* on your fractional measurement. The only way to ensure 100% accuracy is by toggling back and forth between the fractional display and the decimal display. With these calipers you can read the fraction and the decimal equivalent at the same time so you know that 1/2" is exactly .5", not .51" or .49". Constructed of high-quality hardened and ground stainless steel components with a large easy-to-see display which reads in inches with fractions or millimeters. The precision-ground measuring faces allow for outside, inside, depth and step measurements. The extremely accurate fraction readouts are displayed using "Precise Fraction Technology" which gives with decimal inches displayed in .001" increments and the millimeters in .01mm increments.

- 147829** \$41.99

CROWN Rosewood And Brass Cutting Gauge

The Rosewood Cutting Gauge is designed for accurate scoring across the grain without tearing. The 1/4" single beveled cutting iron is held in place by a brass wedge, and a brass thumbscrew grips the sliding post securely. Solid rosewood fence has two inlaid brass wear plates. Overall length is 8". Made in England.

- 06V11** \$40.99

CROWN Rosewood And Brass Marking Gauge

The Crown Rosewood Marking Gauge performs two operations. One side of its post has a single pin for general marking with the grain or on end grain; the other side has double pins adjustable to approximately 2" for the layout of mortises. Gauge is made with solid brass hardware, wear plates, and fitted with a milled thumbscrew in the head. Overall length is 7 3/4". Made in England.

- 14C12** \$69.99

WoodRiver® 12" Combination Square

Whether you're a hobbyist or professional woodworker, the one tool that everyone relies on is a quality combination square. The WoodRiver® 12" (300mm) stainless steel blade is micro-fine etched with black castings for easy reading. One side of the blade is graduated with 1/8" and 1/32" increments, while the other side is graduated with 1/16" and 1/64" increments. The square head comes with a level vial and steel scribe tool, making this one of the best combination squares available. The two-piece set includes 12" blade and square head in a padded blow mold case.

- 154239** \$29.99

WIXEY™ Digital Protractor

Get quick, accurate measurements of existing angles from mitered trim work, crown molding, roof slopes, or wall corners. This tool helps measure the true angle of inside and outside wall corners molding and chair rail miter joints. Large display reads angles from 0 to 180°, and can be zeroed at any point in the swing of the protractor's leg - just read the angle measurement directly from the digital protractor. Each 9" long x 2" wide aluminum leg has built-in magnets to help hold the protractor to metal surfaces.

- 148564** \$64.99

GENERAL® TOOLS 828 Digital Sliding T-Bevel

This highly accurate tool offers easy-to-read measurements via a large LCD display and has an 8" stainless steel blade and steel locking knob. It is ideal for measuring, storing and transferring inside and outside angles when building cabinetry, furniture and picture frames. The 828 also offers pioneering technology that takes the guesswork out of angle duplication and eliminates the problems associated with manual measurement transfer. Instructions and battery included.

- 153776** \$38.99

WoodRiver® Fractional Dial Caliper

It didn't exist so we had it made for us! One turn of the dial equals an inch, a feature that no other dial caliper has. Measures to 6 1/2", calibrated in 64th's of an inch. Caliper is machined from hardened stainless steel for long life, dial indicator is shockproofed. Comes in a foam-padded molded plastic case.

- 143963** \$57.79



10" Metal Sliding Bevel

This high-quality Japanese sliding bevel sets with a twist of a rear-locking screw. The rear locking screw also allows you to lay the bevel flat on either side. The heavy 10" blade is mounted in an aluminum handle.

- 146020** \$29.99



Marking & Measuring

WOLVERINE Vari-Grind 2

Produce and maintain perfect fingernail, and side grind, profiles on spindle and bowl gouges. The new Vari-Grind 2 offers "side restrained action" to keep the tool safely centered on the wheel, eliminating the chance for slipping of the wheel's edge. Sharp, consistent profiles are easy because the tool rotates about the center of the adjusting rod allowing maximum flexibility, not only in matching a profile but also in creating your own. Available with or without the base.

843656 complete w/base **\$109.99**
843655 w/out base **\$74.99**



WOLVERINE Grinding & Sharpening Jig

Wolverine Grinding Jig. Create accurate cutting angles and straight edges, easier and safer, in a fraction of the time it now takes! The Wolverine system is furnished with two bases, one to mount under each wheel, which permit two simultaneous grinding set ups. Each base accepts either sliding arm. Arms are effortlessly adjusted or secured by a cam locking device. The "V" arm attachment is 27" long and perfect for sharpening gouges, skewers, chisels, or carving tools. The 3" x 5" platform jig uses quick release ratchet handles for angle adjustments and is perfect for sharpening scrapers. Complete with instructions for installation and use.

125676 (A) **\$89.99**

Turner's Fingernail/Side Grinding Jig. Grinding difficult fingernail profiles on shallow spindle gouges

and side grinds (also called Irish or long grinds) on deep fluted bowl gouges is quick and easy when you use the Vari-Grind Fingernail/Side Grinding Jig. The Vari-Grind combines "roll & swing" motion into one easily controlled movement that results in an edge so perfect you'll be amazed at how easily you formed it! Use with Wolverine Grinding Jig (shown in use above), or any other "V" arm system, for maximum control and perfect, repeatable fingernail and side grinds.

125677 (B) **\$55.99**

Wolverine Skew Jig

Now, sharpening skew tools is a snap. Simply attach the skew jig to the Wolverine V-arm, lock in place and you're ready to go.

127187 (C) **\$32.99**

Wolverine Dressing Attachment This wheel dressing attachment removes glazing and produces clean, truly round wheels quickly and easily. The precise adjustment knob allows you to remove as little as .002" per pass over the grinding wheel. Not pictured.

127727 **\$69.99**

WOLVERINE Platform Kit

We've taken one of the Wolverine's standard bases and platforms to create a kit for sharpening chisels and plane blades using an ordinary grinder. The base attaches to the bench underneath the grinder and features Wolverine's system of adjustment so distance from base to the stone is easily set. If you would like to increase the versatility of your grinder this is one of the best accessories you can own. Some assembly required.

150878 kit **\$59.99**

833170 base only **\$32.99**

834132 platform only **\$29.99**

RIKON Slow Speed 8" Grinder



The Rikon model 80-805 Slow Speed Grinder features a smooth starting, powerful 1/2 HP motor. The grinder operates at 1,750 RPM, which is ideal for sharpening operations because it reduces heat build-up and minimizes the possibility for "bluing." This grinder comes equipped with two 1" x 8" white aluminum oxide grinding wheels: one 120-grit wheel and one 60-grit wheel. The cast-iron base features anti-vibration rubber feet and is equipped with mounting holes for convenient attachment to a workbench or grinder stand. Grinder comes with Tool Rests, Eye Shields, Spark Arrestors, 6' Power Cord And Five-Year Warranty.

158512 **\$139.99**

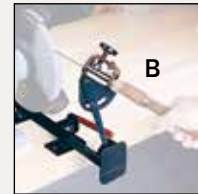

RIKON & WOLVERINE Sharpening Kit

Our Woodturner's Sharpening Kit brings together three of our individual best sellers. First is the Rikon 8" Slow Speed Grinder (above) outfitted with 60- and 120-grit white aluminum oxide wheels turning at 1,750 RPM. Next are Oneway's Wolverine Grinding and Vari-Grind Jigs. These three tools offer the capability to sharpen just about any standard turning tool. Easy to use and set up, the Oneway jigs are almost as fast as freehand sharpening and certainly more accurate.

158820 includes A, B, C **\$269.99**

Razor Sharp Edgemaking System

Absolutely the fastest, easiest way to put an edge on tools and knives we've seen. The Razor Sharp system is comprised of two laminated paper wheels, for either 1/2" or 5/8" arbors, one for grinding and one for buffing. Use the silicon carbide grinding compound/ wax and jewelers rouge on the wheels for a mirror finish. The System includes: grinding wheel, buffing wheel, silicon carbide, conditioning grease, jewelers rouge and instructions.

124629 Razor Sharp System **\$56.99**

151129 repl. grinding wheel **\$31.50**

151130 repl. buffing wheel **\$29.99**

151126 jewelers rouge **\$8.50**

151127 wax **\$10.99**

151128 silicon carbide **\$10.99**



PFEIL Swiss Made® Marking Knives

Marking knives are the most accurate way to mark lines for fine joinery layout work. The flat steel blades on these knives are beveled on only one side so you can mark tight against your straight edge. These knives feature a K720 steel blade with a beautiful Bubinga handle that fits snug in your hand for easy gripping and control. Blade is 3/4" wide and 1 7/8" long; overall length is 6".

05E72 (A) right bevel **\$36.19**

05E73 (B) left bevel **\$36.19**

05E74 knife set A & B, **SAVE!** **\$65.09**

PFEIL Swiss Made® Marking Knife Kit

These beautiful Swiss made marking tools are perfect for all your joinery layout work. Features a K720 steel blade with a 60° ground point that allows the knife to be used left- or right-handed. The round Bubinga handle with two small flats, to prevent the tool from rolling on your benchtop, fits in the hand like a pencil for accurate marking. Small blade -1 3/8" x 1/2", large blade -1 1/2" x 3/4", 7" overall length.

05Z25 lg. blade w/handle 1 1/2" x 3/4" **\$25.99**
05B47 sm. blade w/handle, 1 3/8" x 1/2" **\$25.99**
05B46 set of two blades only **\$34.99**

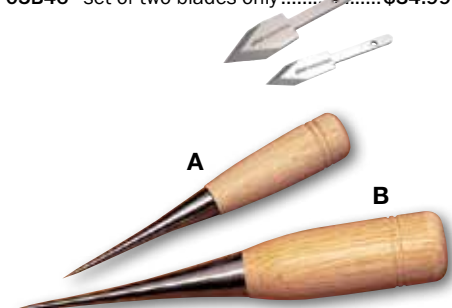

Socket Awls

These socket awls are forged from the best quality tool steel. The tip is ground to a needle point and is suitable for scribing a line or for heavy use as a punch awl. The handle is made from top quality Japanese White Oak, attached to the blade with a socket and tang for a life time of use.

156726 (A) Length: 4 1/2" **\$11.00**

156739 (B) Length: 6" **\$16.99**

Technical Questions?

Call 1-800-535-4486
 For FREE help, and advice!



WoodRiver® 120-Grit CBN Grinding Wheel

8" x 1" For Grinders With A 5/8" Arbor
Our WoodRiver® CBN (Cubic Boron Nitride) Coated Grinding Wheel is used for grinding steel of all kinds and enjoys a distinct advantage over a traditional Aluminum Oxide (AO) grinding wheel. The CBN coating is tough and will never load up or require dressing to remain flat, plus wheel balance isn't an issue because the wheel is machined from a steel plate. The CBN coating and the steel wheel work together to keep heat at bay, so bluing a tool is less likely, and the coating will last a really long time. There is also no danger of the wheel breaking or fragmenting during use and while this is certainly an added safety feature, we recommend the wheel be used with all guards in place. For use on slow-speed grinders with a 5/8" arbor. Made in China.

159256 \$149.99



Micro-Fine Honing Compound

This green, chromium oxide compound works well with leather power strops and felt wheels operating at or below the 1,750 RPM range. Charge your leather bench strops for superior hand-honing of tools. The .5 micron particle size leaves a cutting edge on your plane irons, chisels, and carving tools razor-sharp, and with a mirror finish. 20 oz. bar.

06L01 \$26.99

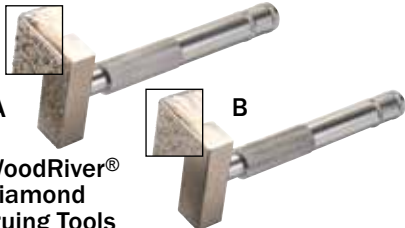

WoodRiver® Diamond Truing Tools

WoodRiver® is offering new, improved versions of the original nickel-plated Diamond Truing Tool we've sold for years. A new tougher plating process holds the diamonds more securely, and the tool is available in two grits: 36 and 120. Now, it's even easier to take the hills and valleys out of your grinding wheels with a dressing surface 1/2" wide and 1 3/4" long; overall tool length is 4 5/8". Uniform reconditioning of your wheels is as simple as placing the dresser on your tool rest and contacting the wheel.

158522 (A) 36-grit \$17.99
158523 (B) 120-grit \$17.99



Honing Guide Speeds Sharpening

You can hone edge tools between grindings with this unique self-centering guide. Chisels and plane irons from 1/16" to 2 5/8" wide can be held securely in one of the two sets of stepped jaws. The accurately ground hardened steel roller glides across the surface of the stone to allow for a consistently fine edge.

03A21 \$14.99

OptiGrind™ 8" x 1" 170/220-Grit CBN Grinding Wheel

For 8" Slow-Speed Grinders

Cubic boron nitride (CBN) is the coating used on this steel wheel. It is superior in every measurable way for grinding hardened steels – far better than aluminum oxide wheels and diamond coated wheels. How so? CBN is a good conductor of heat so most of the heat generated by grinding is dispersed quickly. The wheel is balanced, flat and true – it will never require dressing. The coating is tough – it will not come off (we've tried)! CBN is four times harder than aluminum oxide and while not as hard as diamond, CBN won't form carbides with the steel it's grinding as diamonds will, which means that it will last a long, long time. Finally, the wheel won't break or fracture, won't come apart, and generates little if any sparks. The OptiGrind is 170/200-grit, which is optimal for effective stock removal and sharpening without being overly aggressive. It is a full 1" wide with one flat face coated about 3/4" from the edge. We offer the OptiGrind™ wheel and special flange as a single unit to fit a 5/8" arbor, such as the one on our Rikon (158512) Slow-Speed Grinder. Made in Austria.

159099 \$224.99

Camel Aluminum Oxide Wheels

Aluminum Oxide grinding wheels are made from granulated aluminum oxide with a vitrified bond which permits the surface to fracture under use, constantly refreshing the cutting surface.

This means faster grinding and more importantly, cooler grinding. If you're a turner, these wheels are a must. Pink wheels are a little harder than the white, so they are more resistant to grooving and will require less dressing.

60 Grit 120 Grit Dia. Color Width

01W44 01W43 6" ... White ... 3/4" \$25.99

01W48 01W47 8" ... White \$36.99

N/A 127251 6" ... Pink ... 3/4" \$51.50

N/A 127253 8" ... Pink \$51.50



Veritas® Grinder Tool Rest

The Veritas® Tool Rest mounts solidly to your bench in front of the grinder and provides a sturdy, square support that can be folded out of the way for free hand grinding operations. The 4"-wide tool rest may be used with 6" or 8" grinders and can straddle wheels up to 1" wide. It also works well as a tool rest for belt sanders. Includes an angle setting gauge.

153365 \$57.99

Veritas® Sharpening System

The guide, which holds blades up to 2 3/8" wide and 5/8" thick, has a unique cam roller that makes creating a micro bevel a simple task. System comes with an angle setting jig for establishing and maintaining the primary bevel, complete instructions, and suggestions on stone selection and how to get the most from your tools. This easy-to-use, almost foolproof system will help you sharpen to a razor-sharp edge.

153784 \$46.99



Veritas® Mk.II Honing Guide

Deluxe Set

The Veritas® Mk.II Deluxe Set includes the Standard and Narrow-Blade Heads as well as the Angle Registration Jig, a Straight Roller Base and a Camber Roller Base. The Narrow-Blade Head fits blades from 1/8" to 1 1/2" wide, bevel-edged chisels up to 15/32" thick, and square-edged chisels up to 1 1/32" thick. Bevel angles are honed from 15° to 40°, back bevels from 10° to 20°. The Standard Head fits blades from 1/2" to 2 7/8" wide, and hones bevel angles from 15° to 54°, back bevels from 10° to 20°. The Straight and Camber Rollers attach to the clamping heads permitting a precise micro bevel to be added to any angle. The wide Straight Roller provides a stable base for accurate results, and the Barrel Shaped Roller cambers plane blades. Complete instructions are included.

160876 \$119.99

Veritas® Mk. II Honing Guide

The Veritas® Mk. II Honing Guide allows you to set bevel angles from 15° to 54° and back bevels from 10° to 20°, and it accommodates blades from 1/4" to 2 7/8" in width for repeatable results. Features include a blade registration jig for centering and squaring the blade, and a blade stop with discrete positions for preset bevels. A three-position eccentric roller allows you to hone micro bevels with a simple turn of a knob. Manufactured from die-cast zinc with precision machined brass and steel parts.

833173 \$69.99

Veritas® Mk.II Narrow-Blade Honing Guide

Whether beveled or square edged, the chisel blades are kept centered and tight to the reference face of the jig plate to ensure a precise cutting edge. For blades from 1/8" to 1 1/2" wide, bevel-edged chisels up to 15/32" thick, and square-edged chisels up to 1 1/32" thick with bevel angles from 15° to 40° and back bevels from 10° to 20°.

Complete instructions are included.

160874 \$84.99

Veritas® Mk.II Narrow-Blade Clamping Head

Fits the Veritas® Mk.II Honing Guide, to precisely sharpen chisels. Whether beveled or square edged, the chisel blades are kept centered and tight to the reference face of the jig plate by parallel, canted jaws to ensure a precise cutting edge. For blades from 1/8" to 1 1/2" wide, bevel-edged chisels up to 15/32" thick, and square-edged chisels up to 1 1/32" thick, with bevel angles from 15° to 40° and back bevels from 10° to 20°. Complete instructions are included.

160875 \$48.99

Veritas® Grinding Jig

The Veritas® Grinding Jig solidly clamps and perfectly aligns the tool to be sharpened with its alignment pin system. It slides back and forth across the tool rest groove on the Veritas® Grinder Tool Rest, but it also has riding ledges which allow it to be used with other tool rests.

153366 \$28.99



Sharpening Innovation

NEW



7
YEAR
WARRANTY



TORMEK T-8

Some believe the T-7 is the best motorized sharpener out there – but we know the people at Tormek. They don't sit around collecting awards and congratulating themselves on a job well done. Instead, they continually search for ways to make the best better, and we offer the T-8 as evidence. The T-8 has a new Water Trough with a screw lift for easier fit that reduces water sloshing during removal and a magnetic scraper for efficient cleanup. They included the improved Square Edge Jig (SE-77), which has a movable side to permit fine setting adjustments that ensure 90° corners and the ability to create a chambered shape on plane irons. But the real kicker is the new body. Instead of a two-part sheet metal/internal support body with mounted sleeves for the universal support, the T-8 has a precision one-piece fully cast body, with the sleeves cast into the body. This design provides unparalleled stability that improves both control and accuracy to make the T-8 the premier sharpening machine and a worthy successor to carry on Tormek inventor Torgny Jansson's vision. Since Jansson founded Tormek (short for Torgny's Mekaniska) in 1973, the Swedish company has continued to produce, refine and improve on the best solutions for sharpening edge tools.

● 161407 \$699.99

Tormek Master Kits!

- 159921 Hand Tool Kit **Save!**..... \$215.00
- 839785 Woodturner's Kit \$334.00
- 162109 T-8 & Hand Tool Kit **Save!**..... \$334.00
- NEW!**..... \$882.00
- 162110 T-8 & Woodturner's Kit **NEW!**..... \$998.00
- 162111 T-8, Magnum Hand Tool & Woodturner's Kit **NEW!**..\$1,182.00
- 162112 T-8, Ultimate Hand Tool & Woodturner's Kits and Joints/Planer Blade Jig..... **NEW!**.....\$1,347.00

Tormek® T-4 Water Cooled Sharpening System

The Tormek T-4 is a second generation compact sharpening machine. Unlike the previous T-3, all the vital functions of the T-4 – including the motor, main shaft and mounting supports for the Universal Tool Support – are now integrated in a zinc casting. The result is a significant improvement in stability and precision for the Universal Tool Support, which is the base from which all Tormek® Jigs operate. The Tormek® 8" (200mm) original grindstone is optimized for efficient grinding while providing a smooth finish and preserving edge life. The property of the stone's surface can be change from 220-grit to 1000-grit with the Tormek® Stone Grader which, combined with the leather honing wheel and special honing compound, changes your T-4 from a grinder to an efficient sharpening machine. The T-4 is supplied with Stone Grader SP-650, Angle master WM-200, Honing Compound PA-70, owner's handbook HB-10, and an instructional DVD. 861412\$399.99



Rotating Base

RB-180, a really useful addition to the Tormek system. Now you can easily rotate the machine 180° and lock to select the ideal wheel turning direction for each type of work/tool. 154297\$57.00



Square Edge Jig SE-77
840358.....\$60.00



Knife Jig SVM-45
11Q37.....\$39.00



Machine Cover MH-380
129824.....\$27.00



Truing Tool TT-50
147748.....\$89.00



Long Knife Jig SVM-140
840765\$56.00



Multi Jig SVS-50
129353.....\$68.00



Stone Grader SP-650
11Q45\$29.00



Short Tool Jig SVS-32
142899\$28.00



Tool Rest SVD-110
11Q50\$38.00



Joints/Planer Blade Jig
11Q44\$192.00



Scissors Jig SVX-150
11Q39\$54.00



Axe Jig SVA-170
11Q43\$19.00



Profiled Honing Wheels
146034 LA-120...\$64.00



AngleMaster WM-200
129354.....\$27.00



Turning Tool Setter
147490.....\$34.00



Knife Jigs, (B requires A)
11Q37 (A) SVM-45\$39.00
Small Knife Acc. (B)
158360 SVM-00 \$33.00



NEW!
Gouge Sharpening Jig
161393 SVD-186 \$97.00



4-Facet point!

DBS-22 Drill Bit Jig
Create a 4-facet point on the twist drill, even broken drills. Sharpen bits from 1/8" to 7/8" in diameter and fits with all Tormek models. 151248 D/S \$280.00

Japanese Waterstone

The Tormek Japanese Waterstone Wheel excels at sharpening carving tools, knives, scissors, plane irons and wood chisels with a minimum of steel removal leaving a superior surface finish.

- 149545 T-7 (shown)\$386.00
- 416886 T-3..... D/S \$250.00



Blackstone Silicon

The SB-250 was developed for hard materials and fast shaping where grinding pressure is limited such as with planer blades and woodturning skews, or to touch up carbide. The grit is 220 and can be graded with the Stone Grader (SP-650) to make it a finer 1000-grit stone. 149544 T-7\$210.00

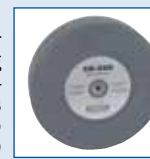

Tormek Repl. Stone

The 250mm comes with the T-7 model (SG-250) and the smaller, 200mm, with the T-3 model (SG-200). Together with the Stone Grader (SP-650) you get two different cutting actions in one stone.

- 11Q47 T-7 (shown)\$184.00
- 416887 T-3 D/S \$109.00



D/S = Item drop ships direct from manufacturer.



Work Sharp® 3000

The Work Sharp 3000 is an innovative air-cooled, dry sharpening system that's ready to use – right out of the box. The 3000's innovative use of solid, tempered, float glass wheels; a "see-through", slotted wheel; high-quality, replaceable abrasive discs and multiple access points enable you to sharpen a wide variety of tools with a precision and delicacy not often found on a powered grinder. Full access to the top surface and an adjustable tool rest permit the grinding, sharpening and honing of large tools while the precision sharpening port provides for accurate sharpening of chisels and plane blades up to 2" wide with one of four preset angles - 20, 25, 30 or 35 degrees. Finally, use of the "see-through" wheel and large port, providing access from under-

Work Sharp® 3000 Wide Blade Attachment

Use your Work Sharp 3000 and this attachment to grind, sharpen, and hone most plane or chisel blades up to 3" wide. The attachment has three main components: a plate which attaches to the back of the 3000; a guide which holds the blade and rides on the plate; and a bevel setter.



149512\$69.99

Work Sharp® 3000 Surface Conditioning Wheel

The pliable, non woven abrasive pad makes short work of rust, paint and anything else that shouldn't be there, without damaging your tool! Includes a top knob for securing the wheel to your WS3000.

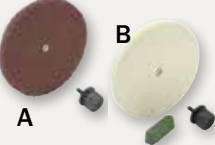

150155 (A)\$19.95

Work Sharp® 3000 Felt Polishing Wheel
Medium density felt wheel used for polishing, de-burring and honing edges between sharpenings. Includes a top knob, fine abrasive compound and a wheel storage bag.

150156 (B)\$24.95

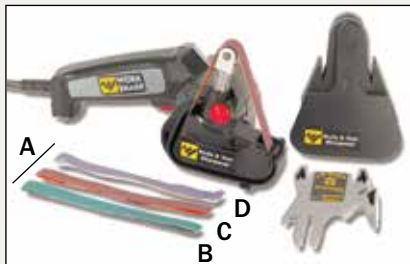

Work Sharp® Knife & Tool Sharpener

The Work Sharp hand held, motorized sharpener, sharpens any knife, scissors, tin snips, garden shears, lawn mower blades and many others. Patented Flex-Tek™ belt technology conforms to the blade, and is easy to use and practically guarantee's a sharp edge. Includes 2 guides for outdoor or kitchen knives, coarse, medium and fine grit sharpening belts, instruction booklet and instructional DVD. Replacement belt kit (A) contains 6 belts, two of each grit.

151170 sharpener\$69.95
151171 (A) repl. belt kit, 2 ea. of 3 grits...\$9.95
154354 (B) belt kit, 80 grit, 6-pc.\$9.99
154355 (C) belt kit, 220 grit, 6-pc.\$9.99
154356 (D) belt kit, 6000 grit, 6-pc.\$9.99

neath, allows you to sharpen tools from below while monitoring stock removal from above. Comes with 2-year manufacturer's warranty, 2 tempered float glass wheels, a "see-through" slotted wheel, top tool rest, crepe stick, and PSA abrasive kit. 110V, 1/5 HP motor, 580 rpm (gear reduced), 16 lbs.

148124 Work Sharp 3000\$199.99

148125 leather hone\$29.99

148126 tempered glass wheel\$19.99

148127 slotted wheel\$19.99

Abrasive Kit, Coarse
 includes P80 (2), P120 (2), P220 (3), P400 (2)

148128\$14.99

Abrasive Kit, Fine
 includes P400 (4), P1000 (6), 2"x2" P400 (2)

148129\$14.99

Abrasive Kit, Hone
 incl. 3600 MicroMesh (1), 6000 Micro-Mesh (1)...

148130\$14.99

Abrasive Kit, Slotted.....includes
 P80 (1), P400 (2), P1200 (2), 6000 Micro-Mesh (1)

148131\$14.99

Work Sharp® 3000 Knife Sharpener

Easily sharpen all your kitchen knives, hunting knives and scissors on your Work Sharp 3000 with their new Knife Sharpener. Replacement belt kit contains one belt of each grit.



151270 Work Sharp 3000 Sharpener....\$59.99

151271 belt kit.....\$12.99

Work Sharp® 3000 Tool Bar Attachment

This tool bar that attaches to the side of any existing 3000 allowing you to use Tormek® and Jet® Wet Sharp Jigs to sharpen turning tools. Complete instructions included. Only fits the Work Sharp® 3000.



153685\$49.95

KEN ONION EDITION



Work Sharp® Knife And Tool Sharpener

Work Sharp has partnered with legendary hall of fame knife maker Ken Onion to develop a new knife and tool sharpening platform with expanded features! The combination of Work Sharp engineering and Ken's industrial design has created a fast, easy way to sharpen all your knives and tools with precision and repeatability. This new sharpener utilizes a fully adjustable (15° to 30°) precision sharpening guide, is variable speed (1200 SFM to 2800 SFM) and has wide, flexible, premium abrasive belts. It will sharpen pocket knives, hunting knives, serrated knives, kitchen knives and any other shape or type of blade.



158978 sharpener\$149.95

158979 belt kit.....\$14.95

SORBY

ProEdge Deluxe Sharpening System

The ProEdge Deluxe, from Robert Sorby, represents the ultimate in sharpening for all of your woodworking, carving, and woodturning tools. The system incorporates a patented angle setter, with preset positions for 90°, 80°, 60°, 45°, 35°, 30°, 25°, 20° and 15° bevel grinds, so you get a consistent grind, every time. The ProEdge Deluxe Sharpening System comes with three aluminum oxide abrasive belts (60 grit, 120 grit and 240 grit), skew jig, standard gouge jig, and a fingernail profiling jig. To create a highly polished finish on any of your tools Sorby also offers a buffing mop that can easily be attached to a pigtail mandrel, and when charged with Sorby's honing paste, this system will produce a razor-sharp edge.



839294 ProEdge Deluxe System.....\$529.99
839292 aluminum oxide belt, 60 grit.....\$9.50
839289 aluminum oxide belt, 120 grit...\$10.50
839291 aluminum oxide belt, 240 grit...\$10.50
845335* (A) pigtail mandrel\$36.50
844896* buffing mop.....\$19.99
829890* honing paste\$15.50
159439 buff kit*\$52.99
835860 tip holder\$12.99
839290 120 grit ceramic belt.....\$13.99
839293 60 grit ceramic belt.....\$13.99
846374 short platform w/arm.....\$33.99
849670 600 grit Trizact belt.....\$19.99
849671 1200 grit Trizact belt.....\$19.99
849672 600 grit Trizact belt.....\$19.99
852324 long grind jig.....\$20.50

Chisel & Plane Blade Sharpening Guide

Sets Up Easily & Folds Compactly!

The adjusting knob determines the bend in the guide's body and the angle of sharpening at the tool's front edge. Angles can be set with the printed scale, a protractor or by eye. Spring tensioned clamp holds tools up to 2 5/8" wide. Two-wheeled rear roller moves in a straight line during use and will not wander sideways like other guides. Lightweight sharpener is made of high-impact Lexan.



03E42\$31.99

3M MicroFinishing & Lapping Film

for sharpening. Manufactured to an extraordinary level of precision and durability. The abrasive is bonded with resin to a very tough, waterproof Mylar film. 3M Micro films cut quickly and produce an excellent finish. They can be used for sharpening everything from plane blades to razors but are at their best with carving tools. The film can be easily cut and applied to a backing of almost any shape. The 12 micron (#1200 grit) quickly removes steel, while the 5 micron (#2500 grit) refines and produces a keen edge. The 1 micron (8000 grit) leaves a mirror finish. And for final stropping, use the 0.3 micron (18,000 grit) film. They come on PSA sheets. One sheet can make a number of specialized hones and stropps.



Purchase Any 5 Sheets & Save 10%

157225 12 micron /#1200 (yellow).....\$4.50
157214 5 micron /#2500 (gray).....\$4.25
157227 1 micron /#8000 (green).....\$4.25
157212 0.3 micron /#18000 (white).....\$4.25

Sharpening



Koch Sharpener HT-2000

Introducing the Koch Sharpening System by Kurt Koch GmbH of Germany, produced for the first time in 110V/60HZ for the U.S. Market. The Koch System changes *everything* about sharpening carving tools because it's simple to use and unbelievably fast. System is comprised of a 1,350 RPM Soga® motor, 4 special composite wheels (2 hard – red and blue for grinding and 2 soft – yellow and green for honing), and two specially formulated abrasive pastes – green for grinding and blue for honing. This unique combination of grinding pastes and wheels is where the sharpening magic happens. Hard wheels use the green paste, with one wheel being dedicated to curved tools and the other for straight tools. All preliminary grinding/sharpening is done on these wheels. Do not fear overheating your tools while grinding, because the special green compound and wheel keep your tool cool. The soft wheels are used with blue paste, with one wheel being dedicated to curved tools and one to straight tools. Here a light touch is all that is required to hone and polish the tool. The wheels will occasionally require truing or dressing, which is accomplished with a medium-grit sandpaper and a wood block.

The Koch System is designed for very safe and easy use. The motor and wheels rotate away from the user, and the wheels are charged with paste as needed and generate no sparks in the process of sharpening. We do recommend a backer board – in the act of charging the wheel, excess paste can be “thrown” back against the board. This paste can be collected and reused. Our experience with this system is unlike sharpening with any other system we've used. Using the system to maintain bevels and honing the edges is easy – almost impossible to mess up and so much faster than we thought possible. A quick demo of its performance involves dragging a small gouge across a cinderblock to create a “hammer,” and then returning it to a cutting gouge in minutes without using any aids or any extensive setup. You are literally back to carving in minutes.

161389 \$499.99



PINNACLE® Arkansas 3-Stone Boxed Set

This set includes three Arkansas stones (soft, hard white and hard black) in a wood storage box. Each stone measures 6" x 2" x 1/2" and is stored in its own slot within the box. Includes 4 oz. of honing oil.

144788 \$44.99

TREND Diamond Stone Lapping Fluid

Trend Lapping Fluid lubricates the surface of a stone to prevent the stone from loading and reduces the threat of rust by up to 95%. It actually improves the performance of any diamond abrasive, making sharpening even easier and faster than ever before.

830444 100 ml. \$16.50

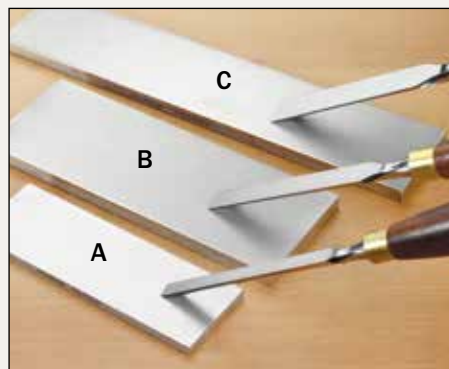

DMT® Dia-Sharp Bench Stones

Dia-Sharp continuous diamond bench stones are guaranteed not to hollow or groove. These precisely engineered stones assure consistent, even sharpening every time, and are ideal for knives, blades and fine tools. Sharpening with diamonds is fast and easy. No messy oils needed - sharpen dry or with water. Durable construction will provide years of consistent performance and reliable service, and diamond grade is clearly marked on side of stone.



DMT® Dia-Sharp Offset Mini-Hone

Sharpen, deburr, and hone safely in tight spaces on your circular saw blades or router bits. The offset design of the Mini-Hone offers better control for hard to reach areas. The uninterrupted monocrystalline diamond surface lets you quickly put a razor edge on pocketknives and small contact area tools. Kit contains one of each grit. Tip measures 2 1/2" x 3/4", .033" thick.

147295 blue, 325 grit \$11.25
147296 red, 600 grit \$11.25
147297 green, 1200 grit \$11.25
147298 3-pc. set **Best Value!** \$29.99



DMT® Dia-Flat™ Lapping Plate

The Dia-Flat™ is designed to flatten all oilstones and waterstones. Flat to +/-0.0005 and coated with the revolutionary DMT® Diamond Hardcoat Technology™, the aggressive diamond coating makes short work of flattening any conventional oilstone or waterstone. 4 lbs. Stones not included.

154353 4" x 10", 160 grit \$199.99

D/S = Item drop ships direct from manufacturer.



819981 (A) 6" x 2", 325 grit.....	\$29.99
819980 6" x 2", 600 grit.....	\$29.99
819979 6" x 2", 1200 grit.....	\$29.99
411913 8" x 3", 220 grit.....	\$59.99
147303 (B) 8" x 3", 325 grit.....	\$60.25
147304 8" x 3", 600 grit.....	\$61.50
147305 8" x 3", 1200 grit.....	\$59.99
411914 8" x 3", 8000 grit.....	\$92.99
147306 (C) 11 1/2" x 2 1/2", 325 grit.....	\$68.99
147307 11 1/2" x 2 1/2", 600 grit.....	\$67.99
147308 11 1/2" x 2 1/2", 1200 grit.....	\$67.99

DMT® Double-Sided Dia-Sharp Stones

Quickly hone a razor-like edge with the uninterrupted diamond sharpening surface of DMT's Double-Sided Dia-Sharp stones. These continuous diamond surface stones provide cutting edge performance and are recognized for their superior quality. The 2" x 6" size is great for both chisels and knives. Sharpening with diamonds is fast and easy. No oil is needed. You can sharpen dry or with water.

147299 325/200 grit..... \$59.99
147300 600/220 grit D/S \$59.99
147301 600/325 grit..... \$59.99
147302 1200/600 grit..... \$59.99

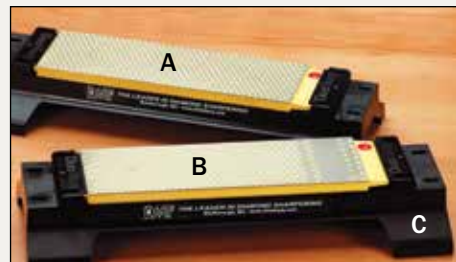

DMT® DuoSharp & DuoSharp Plus

DuoSharp Diamond Stones. A double-sided bench stone is not only more convenient to carry (one stone instead of two), but it's money saver too! They'll sharpen, hone and lap, all types of woodworking tools including knives, chisels, plane blades, gouges, and carbide router bits. Stones measure 8" x 2 5/8" and 10" x 4". Base sold below.

with mat, no base
140963 (A) 8" 1200/600 grit..... \$105.99
140964 8" 1200/325 grit..... D/S \$102.99
140965 8" 600/325 grit D/S \$102.99
140966 8" 325/220 grit..... \$105.99
817198 10" 1200/600 grit..... \$144.99
817199 10" 1200/325 grit..... D/S \$144.99
817200 10" 600/325 grit D/S \$144.99
817201 10" 325/220 grit \$144.99

DuoSharp Plus. These stones have all the features of the standard DuoSharp stones with the bonus of a solid diamond coated area for sharpening small or pointed tools. This feature is like having a 6" honing stone and a sharpening card all in one stone. **Bonus - Buy the Stone and Base combo and Save Over \$16!**

with mat, no base
146026 (B) 8" 1200/600 grit D/S \$94.99
146027 8" 600/325 grit D/S \$94.99
 with base, no mat
146024 8" 1200/600 grit..... \$104.50
146025 8" 600/325 grit \$104.50

(C) DMT DuoSharp Base
 Holds DMT DuoSharp stones securely in place and elevates them off the work surface for more accuracy and comfort.
141103 \$24.99





PINNACLE® Arkansas Stones

True Arkansas Novaculite is renowned for its ability to both cut and polish steel. There is no finer natural stone or a better value in sharpening today. These stones are best used with either oil or water as a lubricant to help float away metal particles. However, you cannot use water once oil has been introduced and used on the stone as it will no longer absorb water.

(A) Washita stones are the softest and most aggressive. Used for taking out large nicks, re-beveling and flattening. Stone colors may vary, box included.

145723 8" x 3" x 1/2" **\$34.99**

(B) Soft Arkansas stones are slightly softer than hard Arkansas. Best general-duty stone for multi-purpose sharpening. Stone colors may vary, box included.

145722 8" x 3" x 1/2" **\$29.99**

(C) Hard Black stones are the hardest and finest stones. Used for a honed, highly polished edge.

145721 8" x 3" x 1/2" w/box **\$54.99**

Arkansas Stone Sets includes the full range of grits - Washita, soft and hard. Hardwood storage boxes included.

145724 8" set of 3 Save! **\$91.99**

(D) Pinnacle Arkansas Combo Stones

One of the best values in sharpening, combos are created by bonding two thin stones of different grits or properties together to create one stone. For our stone, we chose a soft white (general sharpening) stone and a hard black (polishing) stone to make the perfect combo for handling all your sharpening needs. Both come in a wood storage box with a hinged top. Two sizes available.

149103 8" x 2" x 3/4" **\$64.99**

158157 combo pkt. stn., 4" x 2 5/8" x 7/16" **\$16.99**

(E) Pinnacle Hard White Arkansas File Set

3 files (triangle, round and square) and a knife edge slip. Perfect for detail polishing, removing burrs, or dressing the insides of small tools. All files are approximately 3 3/4" long. Knife-edged slip is approximately 3 3/4" x 1/4" - 1/8". All neatly packaged in a wood storage box with a hinged top.



149101 **\$25.50**

Natural Polishing Waterstone

An extremely fine (12,000+) grit natural waterstone quarried in the Guangxi province of China. This stone is dense and perfect for final polishing on all your carving tools, plane blades, chisels or any tool requiring a keen edge. If you've been wanting a natural polishing stone but have been put off by the cost, we urge you to try these stones.

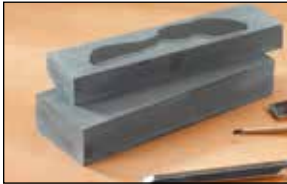

144950 8" x 2 3/4" x 1 1/4" **\$40.99**

144951 8" x 2" x 1" **\$26.50**

Granite Surface Plate

The super-flat face of a granite surface plate is ideal for leveling plane beds, flattening waterstones, and general sharpening duties. Simply soak a piece of wet dry sandpaper in water and lay it on the stone, the capillary action of the water adheres the paper to the stone eliminating the need for spray adhesives or PSA sand paper. When done, wipe clean with a paper towel. Plates are tool room "A" grade with calibration certificate and available in three sizes.

5 Star Rated!



144838 2" x 9" x 12" **\$36.99**

153108 3" x 12" x 18" **\$89.99**

153109 2" x 6" x 18" **\$43.99**

WoodRiver® Leather Bench Strops

Strops remain the traditional honing system for carvers and whittlers because they're so easy to use. Just prime the leather with the appropriate compound and hone your tool with a lapping "barber's" stroke. Prime leather stropping surfaces measure 2" x 8", are milled flat, textured to hold the lapping compound and are bonded right up to the edge of a hard maple base. Handled version has leather stropping on both sides for charging with compounds of different grits.



18H21 bench strop **\$30.50**

18H33 handled, 2-sided strop **\$44.99**

Arkansas Multiform Slipstones

Fits Gouges And V-Parting Tools!

The two different edge shapes makes these stones universal sharpeners. One edge is tapered from a 1/2" to 1/8" diameter to handle the various curves on tools. The second edge is a straight, angled taper knife edge for honing small and large V-parting tools. Stones are approximately 4" x 2" with 1/2" to 1/8" tapers.



08Y32 soft white **\$16.50**

08Y22 hard white **\$18.99**

141924 hard black **\$27.99**

142345 3-pc. set, Best Value! **\$44.98**

Spyderco® Spyderco Ceramic Sharpening Stones

Ceramic stones, unlike man-made Japanese waterstones or man-made oil stones, require no lubrication. The medium (brown) stones have a grain structure ideal for reshaping a blade or removing nicks and will show wear over time or with heavy use. The fine and ultra fine (white) stones do not wear at all and have a grain structure that excels at polishing the edge of any steel.

Spyderco® Bench Stones

Guaranteed flat (within .020), these 2" x 8" stones are ideal for sharpening and polishing a wide variety of chisels or plane blades.



Each stone comes packed in a rigid polymer case with rubber feet.

835910 medium/600 grit **\$50.50**

835911 fine/1800 grit **\$50.50**

835912 ultra fine/2000 **\$73.99**

147955 Set of 3 Save! **\$149.99**

Spyderco® File Set

The multiple profiles offered in this set are perfect for small wood carving tools. All the files are a single, fine/1800 grit.



The set of four files includes a round, square, triangle and heart shaped slip and a protective, snap-front suede pouch.

835913 **\$49.99**

Spyderco® Triangle Sharpmaker

The Triangle Sharpmaker is one of the most versatile hand sharpening systems available, but it does so much more that it comes with a DVD, as well as an instruction book! Use it for scissors, nail clippers, snips, straight razors, chisels, paddle bits, router bits, awls, and more. The Sharpmaker comes with coarse and fine triangle sticks, brass rods, storage case and sharpening base.



154754 **\$71.50**

Sharpening Stone Comparison Guide

Compares approximate abrasive grit relationships of American and Japanese stones.

Stone Type	US Grit	Japan Grit
Coarse Crystolon, Coarse India	100	150
Medium Crystolon	180	240
Medium India, Coarse Diamond	240	280
Fine Crystolon, Fine India	280	360
Medium Diamond	320	500
Washita	350	600
Soft Arkansas	500	1000
		1200
Hard White Arkansas, Fine Diamond, Medium Black Ceramic	700	2000
Hard Black Arkansas,	900	4000
Ultra White Ceramic		6000

Sharpening

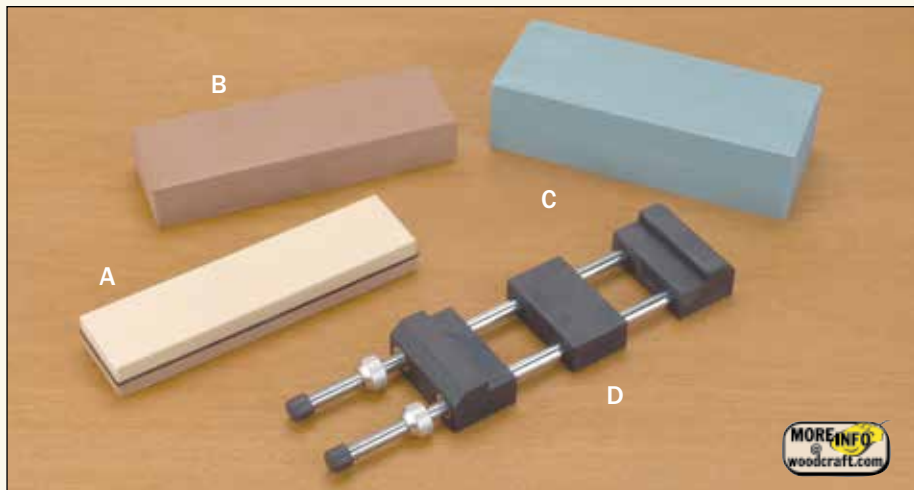

Fast-Cutting Japanese Waterstones

Unlike Western man-made stones, water rather than oil is used on Japanese stones to prevent the surface from being clogged with metal particles. We offer two classes of stone: coarse and finishing. The coarse stones are 250, 800, 1000, and 1200 grit. The 250 and 800 grit are faster cutting and used for repairing nicked edges or reshaping a bevel. The 1000 or 1200 grit stones are used for the first stage of the actual sharpening. The polishing stone or Shiage Toishi contains a polishing compound. A polished edge is quickly established, and unlike harder western stones, any trace or wire edge is removed in a single sharpening. Japanese water stones are softer than Western styles causing a fresh, sharp surface to be continually exposed to the tool edge.

(A) Combination Water Stones.

- 04H22 8" x 2" x 1" 250/1000 \$28.25
- 09C31 8" x 2" x 1" 1000/6000 \$38.25
- 09A21 7 1/4" x 2 1/2" x 1" 1200/8000 \$77.99

(B) King Brand Deluxe Coarse Stones. For repairing and reshaping tools, 8 1/8" x 2 5/8" x 1 3/8".

- 11H31 800 grit \$30.99
- 11H21 1000 grit \$31.99
- 11H11 1200 grit \$31.99

(C) Coarse Grit Japanese Water Stone for flattening and shaping carbide or carbon tool steel blades. Silicon carbide abrasives rapidly remove metal.

Recommended for initial sharpening of dull edges or removing nicks. 8" L x 2 1/8" H x 3 1/8" W.

- 09C21 240 grit \$70.00

(D) Water Stone Holder. Contoured rubber holders keep stones secure during use and provide a non-slip base while sharpening. Arms are made from chrome-plated steel to resist rusting. Holder accepts stones measuring 5 1/2" to 9" in length.

- 09T12 \$21.99



ICE BEAR Waterstones

Ice Bear waterstones cut fast and produce the superior scratch patterns so necessary when moving through the grit range to progressively fine stones. Whether you stop at 4000, 6000 or continue to 8000 and beyond, these stones make the task of polishing your blade's edge easier and faster than ever before. All stones are approximately 7 1/4" x 2 3/8" x 3/4".

- 149289 4000 grit \$28.99
- 149290 6000 grit \$30.99
- 149291 8000 grit \$73.99



NORTON® Waterstones

Introducing Norton's premier system for sharpening woodworking tools, knives, cutlery and other blades. Their synthetic water stones can produce a surface that is almost unbelievably bright and chrome-like while putting a legendary edge on cutting tools. Coarser grit stones are used to remove nicks and for first step sharpening of badly dulled tools. Mid-range grits, 1000 and 4000 take that shaped edge to a very sharp edge, while the 8000 grit is the finishing stone that brings your final cutting edge up and completely removes scratches from the surface. Care must be used to keep from moving coarser grits onto the surface of finer stones, so each tool must be carefully wiped down before it is moved up a step in the sharpening process. Prior to use, stones should be immersed in water for 10 minutes and kept wet during sharpening. The 8000 grit polishing stone needs only a splash of water on the surface to cut properly. These stones quickly expose a fresh cutting surface for use, which over time creates a sort of dish effect. The stones may need flattening with some frequency. The Set of 4 includes 220, 1000, 4000 and 8000 grit stones. All are 1" x 3" x 8".

- 822459 220 grit \$29.99
- 822460 1000 grit \$50.99
- 822461 4000 grit \$67.99
- 822462 8000 grit \$99.99
- 144269 set of 4 \$204.99

Combination Stones. The double grit stones reduce the cost of getting started with waterstones, while providing a full selection of grits. The 1000/4000 stone is a fine general-use stone, while the 220/1000 works as a starter stone if your tools are in rough shape. The 4000/8000 stone is a finish stone set. All are 1" x 3" x 8".

- 818262 220/1000 grit \$42.99
- 818263 1000/4000 grit \$67.50
- 830575 1000/8000 grit \$75.99
- 818264 4000/8000 grit \$87.99

NORTON® Flattening Stone

The softness of a waterstone allows it to quickly develop a fast cutting abrasive slurry. That's a real plus for honing, but a negative when you start to develop shallow indentations and irregularities in the surface. Norton's new flattening stone, when rubbed across your water stone's surface, quickly flattens and refreshes the face. Its coarse grit silicon carbide promotes maximum cutting while the diagonal grooves provide a path for material removal during the process. Stone measures 9" x 3" x 3/4", includes a plastic case for storage and easy-to-follow instructions for use and maintenance.

- 833914 \$30.50



DMT® Diamond Whetstone 6" Sharpeners

411906

These stones are among the most popular in the DMT® line. They feature the most diamonds per square inch in the industry, as well as a proprietary process that ensures near perfect consistency in grit size. The stones also feature the interrupted (polka-dot) surface-recessed holes that collect the metal fines created during sharpening to prevent loading and help make sharpening fast, easy and clean. Last but not least, DMT® stones are engineered to be the flattest on the market. These stones are 6" x 2", available in four grits, and each comes in a plastic storage box, which also serves as a base.

- 411906 black/220 grit (shown) \$49.99
- 411907 blue/325 grit \$51.50
- 411908 red/600 grit \$51.50
- 411909 green/1200 grit \$51.50



Carver's Waterstones

Sharpen every gouge, chisel, and skew in your tool roll with our King brand waterstones. Each set includes a 2 1/2" long teardrop-shaped slipstone and a 4 1/4" x 2 1/2" x 1/2" stone with five concave profiles on one side and a smooth face on the other. The 1000 grit stone is for general sharpening, leaving a polished finish. The 4000 grit is for final honing, leaving a mirror finish.

- 140325 1000 grit set \$27.50
- 140326 4000 grit set \$31.99
- 140327 set of 2 Best Value! \$44.99

Jointer Blade Hones

Now get razor-sharp and knick-free planer knives without removing them from the cutterhead! Unplug your machine, lock the cutterhead in position, align the 4" hone on the knife edge and hone sharp with a few quick strokes. Aluminum oxide hone is 180 and 400 grits, oil prior to use. Diamond hone is 300 and 600 grits, used dry or with water lubrication.

- 09T14 aluminum oxide hone \$15.99
- 123679 diamond hone \$37.99



Shapton Precision Sharpening At Your Fingertips



Shapton Glass Stone® Series

Shapton Glass Ceramic Waterstones are the finest man-made ceramic waterstones ... period! This claim is based largely on two properties – the speed at which the Shapton stones cut and the edge they create. Shapton stones are designed to be harder, faster cutting, and denser than any other ceramic waterstone on the market. Because they remove material quickly, the time required to hold a tool angle on the stone is reduced, making freehand sharpening much easier. Equally important to cutting speed is the consistency of the finished edge. The sharpest cutting edge is created by the finite intersection of two highly polished, flat surfaces. The finishing grits (16,000 and 30,000) of the Shapton stone system leave a polished surface free of scratches, creating a mirror finished, razor-sharp edge. Each stone is comprised of a 5mm-thick glass backing plate fused to a 5mm-thick stone and measures 2³/₄" W x 8¹/₄" L. We recommend purchasing and using the Shapton Stone Holder, as it provides a secure platform and protects your stone when in use.

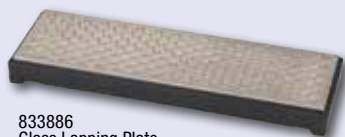

833886
Glass Lapping Plate



839778
Stone Holder

159155	120 grit	\$48.00
834938	220 grit	\$48.00
159156	320 grit	\$55.00
834939	500 grit	\$55.00
159157	500 grit 10mm	\$82.50
834941	1000 grit	\$63.00
159158	2000 grit	\$70.50
159159	3000 grit	\$78.00
834943	4000 grit	\$79.50
159160	4000 grit HC	\$89.50
834944	6000 grit	\$88.50
834945	8000 grit	\$113.00

159162	8000 grit HC	\$124.50
159163	10,000 grit	\$143.00
834946	16,000 grit	\$149.00
834947	30,000 grit	\$360.00
159164	Field Holder	\$84.70
829220	Diamond Ref. Lapping Plate	\$549.00
833886	Glass Lapping Plate	\$379.00
839778	Stone Holder	\$116.00
840485	Sharpening Pond	\$231.00
843394	Glass Stone Set w/Holder	\$306.00

Shapton Traditional/Pro Series

This stone is fired at a high temperature with a mixture of coarse abrasive and a clay binder. It is 8¹/₄" x 2³/₄" x 5/8" and is shipped in a plastic storage case that can be used as a stone holder while sharpening. The case has rubber feet help prevent slippage. These "Splash and Go" stones do not absorb water and do not need to be soaked. Includes quality instructions for sharpening and stone maintenance.



827639	120 grit	\$57.32
831341	220 grit	\$52.99
827104	320 grit	\$57.32
156608	1000 grit	\$58.68
826643	1500 grit	\$65.51

156711	2000 grit	\$68.24
156365	5000 grit	\$88.71
156581	8000 grit	\$113.27
826642	15,000 grit	\$113.27

DEULEN Jointer/Planer Knife Sharpening Jigs

Dan Deulen created these simple sharpening jigs that make sharpening jointer and planer knives easy, cost-effective and fast. The key to the Deulen Sharpeners are the two brass blade holders, inset into the hardwood handle, that hold the blades securely and at the proper angle. With a blade in each track, it is a simple matter of holding the handle and rubbing the blades against an abrasive surface. We recommend Deulin's PSA Abrasives pack which contains six abrasive strips in a progression of grits starting at 120 followed by 150, 180, 220, 320 and ending with 400 grit for final polishing. It couldn't be easier, and the proof is performance. This is so easy to do, you'll no longer put off sharpening your blades. Your machine won't have to work as hard and the wood surface will be smoother with less tear-out. Have more than two blades? No problem! Dan has worked out a system of alternating the



blades that takes just a little more time but yields the same fantastic results. Each sharpener comes with written instructions, a hex wrench and a short how-to video. Two sizes are available: 6" and 12" models. Abrasive paper pack sold separately.

152868	Deulen 12" Jig	\$89.99
152869	Deulen PSA Abrasive pack	\$10.75

Sharpening



Whittling Kit

Whether you're a beginner looking for detailed directions, or an advanced carver looking for a simple way to relax, you'll find what you need in our Whittling Kit. With *The Little Book of Whittling*, our 2-blade carving knife, and a couple of thumb guards you'll be ready to kick back and start making chips. **146793 \$33.59**

PFEIL

Swiss Made® #14 Roughing Knife

This robust knife features an extra-thick 1⁷/₈" long x 1¹/₁₆" wide blade. Perfect for roughing out carvings, making heavy cuts, or as an all-round bench knife. The shape also allows this knife to be used for large scale chip carving. 7³/₄" overall length. **05294 \$31.99**



Woodcarver's Safety Glove

The greatest protection possible against the hand and finger injuries that often result from accidental knife slips. Made from a patented combination of Kevlar, Spectra and stainless steel, this glove is unsurpassed for cut resistance, durability, softness and wearability. Gloves are ambidextrous, tend to run large and can stretch. If in doubt, order one size smaller. Measure around your hand at the fullest part without your thumb: the diameter in inches equals your glove size. USA. **142886 extra extra small, 3" - 4" \$22.99**



06164	extra small, 4" - 5"	\$22.99
06161	small, 5" - 6"	\$22.99
06162	medium, 7" - 9"	\$22.99
06163	large, 9" - 11"	\$22.99

Leather Thumb Guards Protect Thumbs Or Fingers While Carving

Made of split leather with an elastic cloth backing and closed end for extra fit and safety.



16V22	small - children	pair \$5.25
16V23	medium - adult female	pair \$5.25
16V24	large - adult male	pair \$5.25

Canvas Carving Apron

Corral wood chips as you work with this specially designed, American made Canvas Carving Apron. A durable vinyl rod holds the pouch of this heavy-duty, water resistant canvas apron open to catch chips and protect your clothing. Two Velcro strips on the sides allow easy opening to dump shavings. Use it as a standard apron by removing the pouch rod. **158259 \$25.50**



Carving



Power Grip Carving Tools

The handle shape and short blade length of these unique carving tools make them the perfect "gap fillers" between conventional palm-handled and full-sized carving tools. The 4 1/2" handles are designed to be held like a pencil for precise control. When more force is needed place the flared handle end in the palm of your hand. 1 1/4" laminated steel blades. Includes storage box.

Five-Piece Power Grip Set contains a 3mm (1/8") #9 gouge, 6mm (1/4") #8 gouge, 7.5mm (5/16") skew chisel, 7.5mm (5/16") straight chisel, and 4.5mm (3/16") V-parting tool.

18C41 \$49.99

Seven-Piece Power Grip Set contains the tools in five-piece set above plus a 9mm (3/8") #5 gouge and a 9mm (3/8") #3 gouge.

18C42 \$62.50

Brienz Carving Mallets

These extraordinarily high-quality, hand-crafted mallets are made for Woodcraft

by the manufacturer supplying the prestigious Brienz Woodcarving School in Brienz, Switzerland. Used by master carvers and apprentices throughout the world, these lacquered straight grain beech mallets fit comfortably in the hand and give you great control. Weight and dimensions may vary slightly.

	Weight, Oz.	Diameter	Length	
08G08	8 1/2	2 3/4"	10"	\$81.99
08G09	14 1/2	3 1/8"	11"	\$77.50
08G10	23 1/2	3 1/2"	11"	\$76.69

Carver's Soft Head Mallets

Deliver a lifetime of use and accept a lifetime of abuse! The resilient urethane heads of these carver's mallets are almost indestructible, and produce an exceptional, longer-lasting impact force. The anti-shock cushion, load-spreading effect of the urethane head is ideal for woodworkers who suffer from arthritic elbows. We guarantee they won't crack or split. Overall length approximately 10 1/2", with hardwood handles.

	Weight	Head Dia.	
13T41	12 oz.	2 3/4"	\$42.50
141039	18 oz.	2 3/4"	\$47.25
13T51	20 oz. shown	3 1/2"	\$47.50



Technical Questions?

Call 1-800-535-4486
For FREE help, and advice!



Chip Carving Knives

Although designed for chip carving, these knives are used by whittlers and cabinetmakers as special purpose and general bench knives. Hardwood handles are designed to match the blade style and assure tool control. Overall lengths range between 5" and 7". Rc 57-60 hardness. Honing required before use.

15U60	set of 5* Save!	\$79.99
15U20	set of 10 Save!	\$129.99
15U21	A	\$22.99

15U31	B	\$21.99
15U61	C	\$24.99
15U92	D	\$22.50
15U11	E	\$22.69
15U71	F*	\$24.99
15U51	G*	\$13.99
15U41	H*	\$23.50
15U81	I*	\$22.99
15U91	J*	\$21.99

Rick Bütz Carving Knives

Shown in his books and television series, Rick developed these tools to provide carvers with knives that are easier to hold, more efficient in cutting, and safer to use. Require honing before use. Germany.

(A) Carving Knife. The knife Rick uses for roughing out, shaping and general whittling. Sheepsfoot-style blade is set deep in the cherry wood handle. The cutting edge starts right at the handle. Blade is 1 7/16" long, handle 5 3/4" long.

18S22 \$19.99

(B) Detail Knife. The 1 7/16" blade has just the right taper for both maneuverability and strength. The



blade is set deep into the cherry handle, the cutting edge starts right at the handle. The ultimate tool for final cuts that separate an average carving from a master carving.

18S23 \$19.99

18S30 set of 2 Save! \$31.49

18H34 Bütz Strop \$41.99

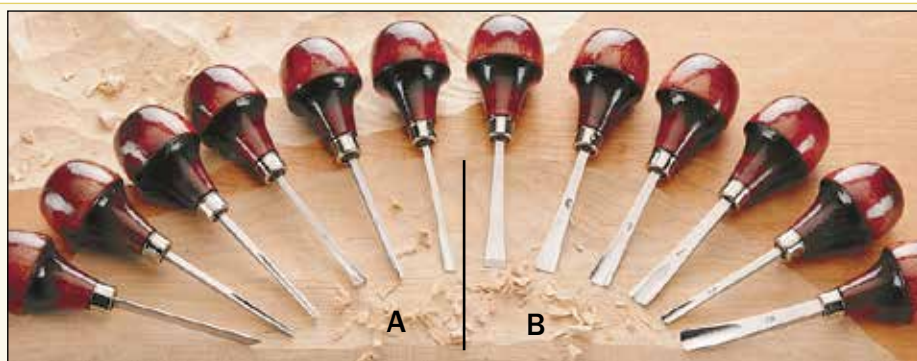

RAMELSON Palm-Handled Carving Set

The overall design of the tool keeps your fingers close to the cutting edge and the comfortable half-round palm-style handles feature a flat spot that keeps them from rolling off your bench. Set A contains smaller cutting profiles for more intricate work. Set B contains slightly larger profiles for quicker stock removal and shaping. Overall length of the tools is 4 3/4". Factory sharpened and ready for use.

09H01	1/4" skew chisel	\$12.99
09H02	1/8" veiner	\$12.99
09H03	1/8" v-parting	\$13.99

09H04	1/4" #5 gouge	\$13.99
09H05	3/16" #5 gouge	\$12.99
09H06	1/8" #3 gouge	\$13.50
09H10	set of 6 tools above (A)	\$69.99
09I01	3/8" chisel double bevel	\$21.50
09I02	3/8" #3 fishtail gouge	\$23.25
09I03	3/8" #5 fishtail gouge	\$22.25
09I04	3/8" #7 fishtail gouge	\$23.75
09I05	3/16" #9 fishtail gouge	\$22.99
09I06	3/8" #9 fishtail gouge	\$22.99
09I10	set of 6 tools above (B)	\$119.99
09I20	set of 12 Save!	\$179.99

SARGE Two-Blade Folding Carving Knife

Features a chip and detail blade so you can carve any time! The 1" long high-carbon stainless steel blades offer excellent edge retention and inhibit rust. The high-strength, ergonomically shaped handle is made of stainless steel with Pakawood inlays. Closed, length is 3 3/4" and a slim 7/16" thick fits comfortably in your pocket.

831906 \$17.99



pfeil® Swiss Made® Carving Tools



1st digit is profile/
sweep, second
digit is width of
cutting edge

Square tang in
handle prevents
twisting

Durable octagonal
shape hardwood
handles from eco-
logically managed
Swiss forests

Internal steel
ferrule under
bolster prevents
handle splitting

Full bolster
distributes
pressure to
handle

Marked
for easy
identification

Tools are smooth
and polished and
hardened to end
of profile

Special alloy
chrome-vanadium
steel is renowned for
its long cutting life

Hand-sharpened cutting
edge, inside sweeps
finely ground and
polished

Width (mm)

We are pleased to be the exclusive United States distributor of Swiss Made tools. Since 1962, we have offered our customers carving tools that we believe are the finest in the world. These tools are made with a dedication to quality unsurpassed in today's high-tech world. Each highly polished blade starts with the best alloy tool steel that is forged and finished to provide a proper balance of strength and weight. Blades are electronically hardened to exacting tolerances and tempered to Rc 59-61 to create a durable, resilient cutting edge that stays sharp longer. Each tool has an octagonal, European hardwood handle finished with solvent-free vegetable oil. Overall lengths range from 9 1/2" to 11" with blade lengths of 3 1/2" to 4". Swiss made tools shave wood smoother and more precisely than any other carving tool. For more info, visit woodcraft.com!

Unfortunately, when tools are crafted to the high standards of our Swiss line, demand often exceeds supply. We make every effort to keep all sizes and styles (over 500) in stock at all times. Sometimes we're out of stock on a particular item because of the limited number of tools our Swiss manufacturer can make.

Many customers find that more than one size and style meets their carving needs. If you can accept a substitute tool, simply list your alternatives when ordering. We recommend you place your Swiss tool orders by using our toll-free number so availability can be confirmed and if necessary a substitute selected.

But if you prefer to place a tool on back order, we'll keep you informed of the status of your order. When stock is received, we will fill your order immediately.



GOUGES

Gouges are forged in various sweeps to remove greater or lesser amounts of wood. For example, roughing out the background for a large relief panel would require a tool such as a 9 sweep. The ridges and hollows formed by this tool would then be leveled with a 2 or 3 sweep gouge. See Sweep Diagrams for tool profiles.



2 Sweep Gouges

05B04	2/2	2mm	\$34.99
05W21	2/3	3mm	\$34.99
05B06	2/5	5mm	\$36.99
05B07	2/8	8mm	\$38.50
05E31	2/10	10mm	\$42.99
05B08	2/12	12mm	\$41.50
05E32	2/14	14mm	\$43.99
05B09	2/16	16mm	\$36.50
05E37	2/18	18mm	\$41.99
05B10	2/20	20mm	\$47.50
05F26	2/22	22mm	\$52.99
05B11	2/25	25mm	\$54.99
05C02	2/30	30mm	\$53.99
05C04	2/35	35mm	\$59.99
05F16	2/40	40mm	\$62.99
05G21	2/60	60mm	\$114.99

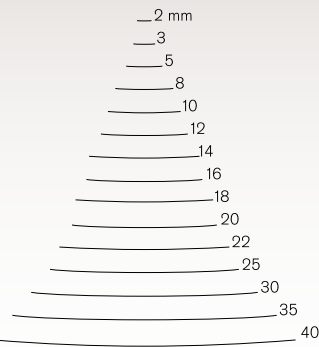

3 Sweep Gouges

05E11	3/2	2mm	\$35.50
05C03	3/3	3mm	\$33.99
05C05	3/5	5mm	\$36.99
05C06	3/8	8mm	\$38.00
05E33	3/10	10mm	\$37.99
05C07	3/12	12mm	\$40.99
05E34	3/14	14mm	\$40.99
05C08	3/16	16mm	\$41.99
05E38	3/18	18mm	\$47.99
05C09	3/20	20mm	\$43.50
05F27	3/22	22mm	\$39.99
05C10	3/25	25mm	\$50.99
05C11	3/30	30mm	\$59.99
05D02	3/35	35mm	\$60.99
05F17	3/40	40mm	\$63.99

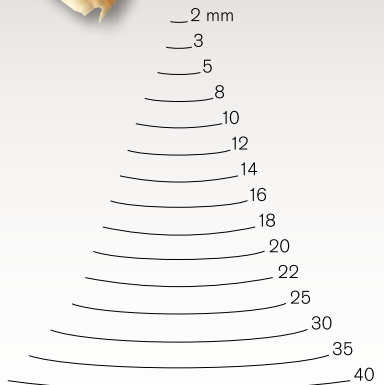

4 Sweep Gouge

05B17	4/2	2mm	\$29.39
05B18	4/3	3mm	\$33.50
05B19	4/5	5mm	\$32.50
05B20	4/8	8mm	\$32.99
05B21	4/10	10mm	\$34.99
05B22	4/12	12mm	\$36.50
05B23	4/14	14mm	\$38.25
05B24	4/16	16mm	\$35.50
05B25	4/18	18mm	\$45.50
05D11	4/20	20mm	\$47.99
05B26	4/22	22mm	\$42.99
05B27	4/25	25mm	\$42.99
05B28	4/30	30mm	\$51.99
05B29	4/35	35mm	\$54.99
05B30	4/40	40mm	\$59.89

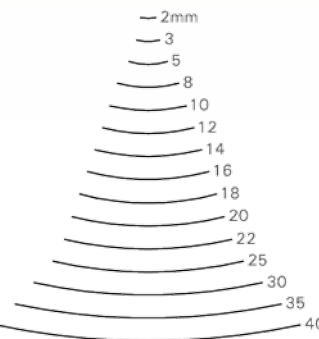

Deluxe Canvas Tool Rolls,
see page 101

#5 Sweep Gouges

05E12	5/2	2mm	\$32.99
05W65	5/3	3mm	\$33.99
05D03	5/5	5mm	\$35.50
05D04	5/8	8mm	\$36.50
05E35	5/10	10mm	\$36.99
05D05	5/12	12mm	\$37.99
05E36	5/14	14mm	\$41.99
05D06	5/16	16mm	\$40.99
05E39	5/18	18mm	\$44.50
05D07	5/20	20mm	\$45.99
05F28	5/22	22mm	\$47.50
05D08	5/25	25mm	\$47.99
05D09	5/30	30mm	\$57.50
05D10	5/35	35mm	\$60.99
05F18	5/40	40mm	\$64.99
05G22	5/60	60mm	\$119.99

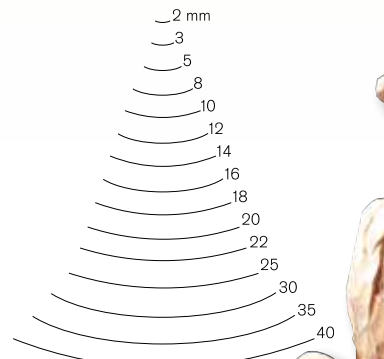

GOUGES



6 Sweep Gouges

- 05B31 6/2 2mm.....\$29.39
- 05B32 6/3 3mm.....\$33.99
- 05B33 6/5 5mm.....\$33.99
- 05B34 6/8 8mm.....\$36.99
- 05B35 6/10 10mm.....\$38.99
- 05B36 6/12 12mm.....\$37.99
- 05B37 6/14 14mm.....\$41.99
- 05B38 6/16 16mm.....\$42.50
- 05B39 6/18 18mm.....\$46.99
- 05B40 6/20 20mm.....\$52.50
- 05B41 6/22 22mm.....\$59.99
- 05B42 6/25 25mm.....\$49.99
- 05B43 6/30 30mm.....\$56.99
- 05B44 6/35 35mm.....\$57.79
- 05B45 6/40 40mm.....\$72.49

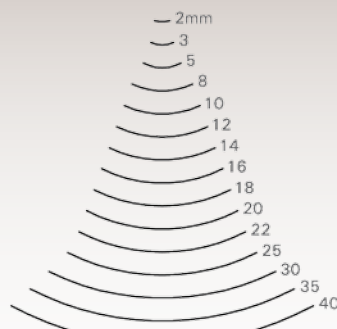

7 Sweep Gouges

- 05E13 7/2 2mm.....\$37.99
- 05E01 7/4 4mm.....\$36.50
- 05E02 7/6 6mm.....\$39.99
- 05E40 7/8 8mm.....\$38.50
- 05E03 7/10 10mm.....\$40.50
- 05E42 7/12 12mm.....\$38.89
- 05E04 7/14 14mm.....\$40.50
- 05E43 7/16 16mm.....\$42.99
- 05E05 7/18 18mm.....\$47.99
- 05W91 7/20 20mm.....\$50.50
- 05F29 7/22 22mm.....\$49.99
- 05E07 7/25 25mm.....\$57.99
- 05E08 7/30 30mm.....\$61.50
- 05E10 7/35 35mm.....\$69.50
- 05F19 7/40 40mm.....\$71.99
- 05G23 7/60 60mm.....\$127.50

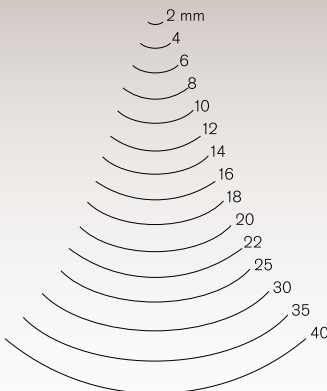

8 Sweep Gouges

- 05F01 8/2 2mm.....\$35.99
- 05X61 8/3 3mm.....\$37.99
- 05F02 8/4 4mm.....\$38.50
- 05F03 8/7 7mm.....\$38.50
- 05F04 8/10 10mm.....\$38.99
- 05F05 8/13 13mm.....\$40.50
- 05F06 8/16 16mm.....\$45.99
- 05F07 8/18 18mm.....\$45.99
- 05E14 8/20 20mm.....\$51.50
- 05F30 8/22 22mm.....\$49.99
- 05F09 8/25 25mm.....\$57.99
- 05F11 8/30 30mm.....\$67.99
- 05F12 8/35 35mm.....\$69.99
- 05F20 8/40 40mm.....\$69.99

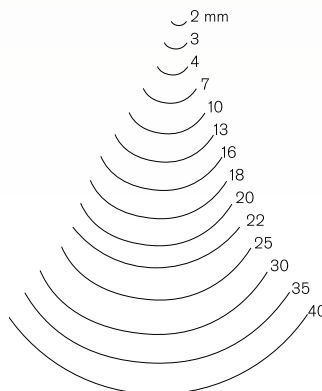

#9 Sweep Gouges

- 05E41 9/1 1mm.....\$31.99
- 05G03 9/2 2mm.....\$33.50
- 05G04 9/3 3mm.....\$37.50
- 05D12 9/4 4mm.....\$36.50
- 05G05 9/5 5mm.....\$37.25
- 05G06 9/7 7mm.....\$40.99
- 05G07 9/10 10mm.....\$43.50
- 05T31 9/13 13mm.....\$40.99
- 05G08 9/15 15mm.....\$43.99
- 05F32 9/18 18mm.....\$39.99
- 05G02 9/20 20mm.....\$49.50
- 05F31 9/22 22mm.....\$49.99
- 05G09 9/25 25mm.....\$51.99
- 05G10 9/30 30mm.....\$57.99
- 05G11 9/35 35mm.....\$69.99
- 05F21 9/40 40mm.....\$75.99
- 05G13 9/50 50mm.....\$131.29

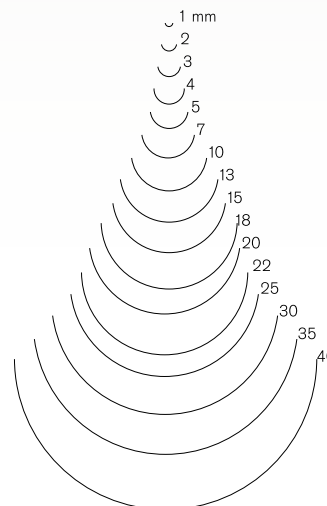

SPOON GOUGES

Shaped similar to an everyday table spoon and most useful in sections where a long straight blade would be impractical because of detail or size of the work. Sweep numbers heading each style refer to the same numbers in the standard tool listing. See Sweep Diagrams for tool profiles.



#3 Sweep Spoon Gouges

- 05W55 3A/3 3mm.....\$30.49
- 05K01 3A/5 5mm.....\$34.69
- 05K02 3A/8 8mm.....\$35.99
- 05K03 3A/12 12mm.....\$39.99
- 05W61 3A/16 16mm.....\$39.99
- 05K04 3A/20 20mm.....\$39.99
- 05K20 3A/25 25mm.....\$43.09
- 05F52 3A/30 30mm.....\$49.39

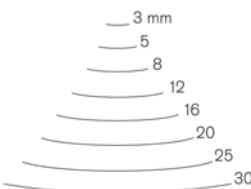

#5 Sweep Spoon Gouges

- 05W71 5A/3 3mm.....\$31.49
- 05K05 5A/5 5mm.....\$37.99
- 05K06 5A/8 8mm.....\$37.99
- 05W75 5A/12 12mm.....\$39.50
- 05K07 5A/16 16mm.....\$41.99
- 05K08 5A/20 20mm.....\$41.99
- 05W81 5A/25 25mm.....\$44.99
- 05F53 5A/30 30mm.....\$49.99

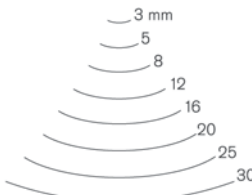

#7 Sweep Spoon Gouges

- 05W85 7A/4 4mm.....\$28.39
- 05K09 7A/6 6mm.....\$33.99
- 05F54 7A/8 8mm.....\$33.99
- 05K10 7A/10 10mm.....\$38.50
- 05K11 7A/14 14mm.....\$53.50
- 05L01 7A/18 18mm.....\$52.50
- 05F56 7A/20 20mm.....\$51.50
- 05W95 7A/25 25mm.....\$59.99
- 05X51 7A/30 30mm.....\$64.99

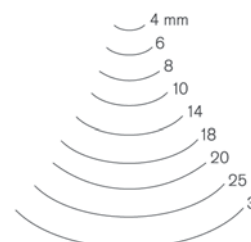

#8 Sweep Spoon Gouges

- 05X65 8A/3 3mm.....\$28.39
- 05L02 8A/4 4mm.....\$29.99
- 05L03 8A/7 7mm.....\$39.99
- 05L04 8A/10 10mm.....\$37.99
- 05X71 8A/13 13mm.....\$36.99
- 05L05 8A/16 16mm.....\$47.50
- 05X75 8A/18 18mm.....\$41.50
- 05F57 8A/20 20mm.....\$48.50
- 05X81 8A/25 25mm.....\$46.99
- 05F58 8A/30 30mm.....\$55.99

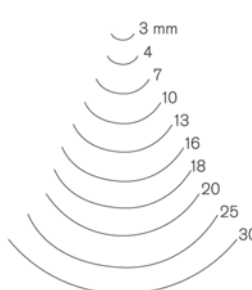

Deluxe Canvas Tool Rolls,
see page 101

SPOON GOUGES

#9 Sweep Spoon Gouges

05F55	9A/2	2mm	\$32.99
05X95	9A/3	3mm	\$34.99
05L06	9A/5	5mm	\$36.79
05L07	9A/7	7mm	\$49.99
05L08	9A/10	10mm	\$42.99
05T35	9A/13	13mm	\$46.99
05L09	9A/15	15mm	\$42.99
05K18	9A/20	20mm	\$50.99

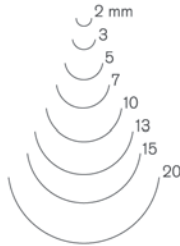

#11 Sweep Spoon Gouges

05F59	11A/1	1mm	\$52.50
05L10	11A/2	2mm	\$36.50
05L11	11A/3	3mm	\$39.99
05T55	11A/4	4mm	\$34.69
05M01	11A/5	5mm	\$38.89
05M03	11A/7	7mm	\$40.99
05T71	11A/10	10mm	\$53.99



SKEWED SPOON GOUGES

These gouges are made especially for completing professional detail work. They combine the spoon curvature, so helpful in accessing tight spots in detail carving, with the point of a skew, so you can reach deep, detailed corners. The skew element also makes these tools shear through grain with ease. See Sweep Diagrams for tool profiles.



#2 Skewed Spoon Gouges

05L12	2A/1L	1mm left	\$30.49
05L13	2A/1R	1mm right	\$30.49
05L14	2A/2L	2mm left	\$34.99
05L15	2A/2R	2mm right	\$34.99
05L16	2A/3L	3mm left	\$39.99
05L17	2A/3R	3mm right	\$39.99
05L18	2A/5L	5mm left	\$39.99
05L19	2A/5R	5mm right	\$34.99
05O10	2A/8L	8mm left	\$39.99

05O11	2A/8R	8mm right	\$44.99
05O12	2A/12L	12mm left	\$49.99
05O13	2A/12R	12mm right	\$36.79
05L20	2A/16L	16mm left	\$36.79
05L21	2A/16R	16mm right	\$32.59
05L22	2A/20L	20mm left	\$39.99
05L23	2A/20R	20mm right	\$39.99
05L24	2A/25L	25mm left	\$41.99
05L25	2A/25R	25mm right	\$41.99

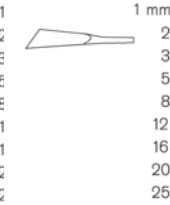
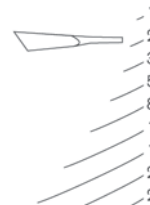

Deluxe Canvas Tool Rolls, see page 101



FISHTAIL GOUGES

A very useful tool for cleaning out corners and undercutting, particularly when side clearance is limited. See Sweep Diagrams for tool profiles.



#1 Sweep Fishtail Gouges

05V45	1F/6	6mm	\$38.99
05M23	1F/8	8mm	\$42.50
05V51	1F/12	12mm	\$42.50
05M24	1F/14	14mm	\$42.99
05V55	1F/16	16mm	\$41.99
05M25	1F/20	20mm	\$43.99
05F85	1F/25	25mm	\$41.99

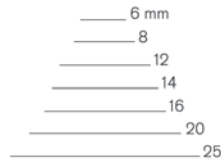

#3 Sweep Fishtail Gouges

05M26	3F/6	6mm	\$44.50
05M04	3F/4	8mm	\$43.99
05M05	3F/12	12mm	\$51.99
05M06	3F/14	14mm	\$47.99
05M27	3F/16	16mm	\$50.99
05M12	3F/20	20mm	\$54.99
05F86	3F/25	25mm	\$69.50

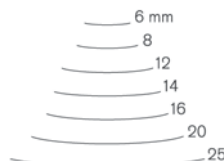

#5 Sweep Fishtail Gouges

05M15	5F/6	6mm	\$38.99
05M07	5F/8	8mm	\$40.99
05M08	5F/12	12mm	\$35.99
05M09	5F/14	14mm	\$50.99
05M16	5F/16	16mm	\$49.99
05M13	5F/20	20mm	\$61.50
05F87	5F/25	25mm	\$59.89

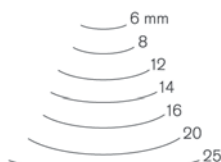

#7 Sweep Fishtail Gouges

05M17	7F/6	6mm	\$40.99
05M10	7F/8	8mm	\$48.50
05M11	7F/10	10mm	\$44.99
05N01	7F/14	14mm	\$49.99
05M18	7F/16	16mm	\$53.99
05M14	7F/20	20mm	\$57.50
05F88	7F/25	25mm	\$54.99

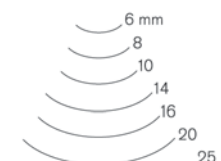

#9 Sweep Fishtail Gouges

05M19	9F/5	5mm	\$41.99
05M20	9F/10	10mm	\$50.50
05M21	9F/15	15mm	\$55.50
05M22	9F/20	20mm	\$64.99

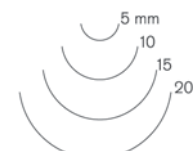

BENT GOUGES

Forged in the same sweep as the standard No. 5, 7 and 8 gouges with an additional lengthwise bend in the blade. This is necessary for roughing out and smoothing concave sections on sculpture and in bowls. See Sweep Diagrams for tool profiles.



#5 Sweep Bent Gouges

05J15	5L/5	5mm	\$37.50
05S07	5L/8	8mm	\$44.50
05N07	5L/12	12mm	\$49.50
05N08	5L/16	16mm	\$44.99
05S08	5L/20	20mm	\$50.99
05F39	5L/25	25mm	\$56.99
05F40	5L/30	30mm	\$54.59
05F41	5L/35	35mm	\$65.99

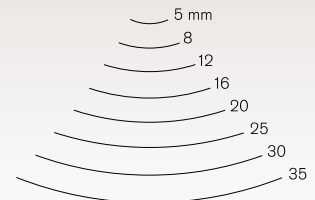

#7 Sweep Bent Gouges

05F42	7L/4	4mm	\$36.79
05J16	7L/6	6mm	\$45.99
05X55	7L/10	10mm	\$42.50
05S09	7L/14	14mm	\$57.25
05F43	7L/18	18mm	\$59.99
05N03	7L/20	20mm	\$56.50
05N04	7L/25	25mm	\$64.99
05N05	7L/30	30mm	\$72.99
05N06	7L/35	35mm	\$72.99

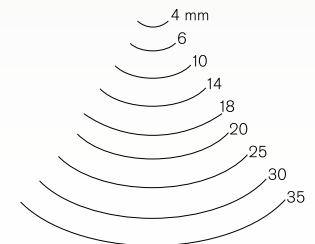

#8 Sweep Bent Gouges

05J17	8L/4	4mm	\$41.50
05J18	8L/7	7mm	\$48.99
05X85	8L/10	10mm	\$49.99
05X91	8L/13	13mm	\$51.50
05F44	8L/16	16mm	\$44.99
05R03	8L/18	18mm	\$56.50
05F45	8L/20	20mm	\$57.50
05R04	8L/25	25mm	\$57.50
05R05	8L/30	30mm	\$84.99
05R06	8L/35	35mm	\$89.99

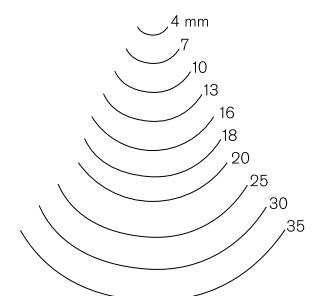

HEAVY-DUTY GOUGES

Crafted to the same high standards as the rest of our Swiss line, these new heavy-duty gouges are the perfect tools for roughing out large work or quick removal of waste stock. Hardwood handles feature double steel ferrules to prevent splitting. Overall length approximately 11½", blade length approx. 5½".



NEW!

161284	1/50	#1 50mm	\$113.89
161285	2/50	#2 50mm	\$120.59
161286	5/50	#5 50mm	\$120.59
161287	7/50	#7 50mm	\$130.69
161288	8/50	#8 50mm	\$130.69
05G12	1/60	#1 60mm	\$92.39
161289	3/60	#3 60mm	\$137.39
161290	8/60	#8 60mm	\$150.79
05X24	1/80	#1 80mm	\$115.49
05G21	2/60	#2 60mm*	\$114.99
05G22	5/60	#5 60mm*	\$119.99
05G23	7/60	#7 60mm*	\$127.50
05G13	9/50	#9 50mm	\$131.29
05G24	*set of 3 Save \$67!.....			\$274.99

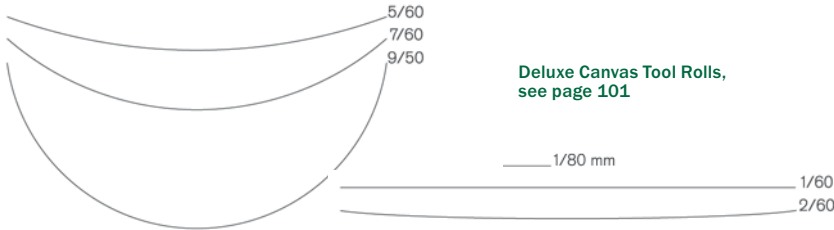

Deluxe Canvas Tool Rolls, see page 101

LONG BENT V-TOOLS

The long bend forged into this parting tool allows the carver to make roughing or detailing cuts on concave surfaces.



#12 Long Bent V-Parting Tools

05F46	12L/2	2mm	\$38.99
05J19	12L/3	3mm	\$45.69
05F47	12L/4	4mm	\$45.69
05T01	12L/6	6mm	\$50.50
05F48	12L/8	8mm	\$50.99
05T02	12L/10	10mm	\$56.99
05F49	12L/12	12mm	\$54.99
05J20	12L/14	14mm	\$59.99

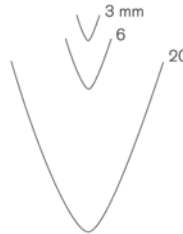
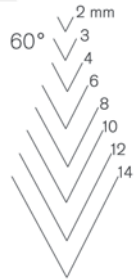

#17 Sweep Stähli V-Parting Tools

Named for its designer, Brienz Woodcarving School master woodcarver, Mr. Stähli. Because of the slight curvature of its "V" (lightly concaved) profile this tool can function as a No. 2 gouge or as a "concaved" V-Parting tool. Great for outlining and rounding over edges at the same time.

05H20	17/3	3mm	\$46.50
05H21	17/6	6mm	\$52.99
05H22	17/20	20mm	\$75.59

CHISELS

Carving chisels have two basic grinding styles, single or double bevel, and two profiles, skewed or straight. Double-beveled grinds are ground with two rounded heels. This allows for the rocking motion so necessary in controlling depth of cut. Single-bevel grinds are ideal for paring and delicate detailing. See Sweep Diagrams for tool profiles.

#1 Sweep Straight Chisel

Double Bevel	Single Bevel	
05A01	1/2	2mm.....05A12 1/2E.....\$38.50
05V81	1/3	3mm.....05A15 1/3E.....\$40.99
05A02	1/5	5mm.....05A16 1/5E.....\$38.99
05A03	1/8	8mm.....05A19 1/8E.....\$40.99
05E15	1/10	10mm...05E16 1/10E...\$40.99
05A04	1/12	12mm...05A22 1/12E...\$41.50
05E19	1/14	14mm..05E20 1/14E...\$41.50
05A05	1/16	16mm..05A24 1/16E...\$44.99
05E23	1/18	18mm..05E24 1/18E...\$55.99
05V91	1/20	20mm...05V02 1/20E...\$55.99
05F22	1/22	22mm...05F25 1/22E...\$54.99
05A06	1/25	25mm..05V04 1/25E...\$52.49
05S05	1/30	30mm..05V06 1/30E...\$55.50
05A08	1/35	35mm..05V08 1/35E...\$52.49
05E27	1/40	40mm..05E28 1/40E...\$62.50



#1 Sweep Skew-Cut Chisel

Double Bevel	Single Bevel	
05V75	1S/2	2mm.....05A13 1S/2E....\$37.50
05V85	1S/3	3mm.....05A18 1S/3E....\$36.99
05A09	1S/5	5mm.....05A17 1S/5E....\$37.99
05A10	1S/8	8mm.....05A21 1S/8E....\$39.99
05E17	1S/10	10mm..05E18 1S/10E...\$38.99
05A11	1S/12	12mm..05A23 1S/12E...\$39.50
05E21	1S/14	14mm..05E22 1S/14E...\$40.99
05B02	1S/16	16mm..05V01 1S/16E...\$40.50
05E26	1S/18	18mm..05E25 1S/18E...\$41.99
05V95	1S/20	20mm..05V03 1S/20E...\$39.89
05F24	1S/22	22mm..05F23 1S/22E...\$39.89
05B03	1S/25	25mm..05V05 1S/25E...\$54.99
05S06	1S/30	30mm..05V07 1S/30E...\$58.99
05B05	1S/35	35mm..05V09 1S/35E...\$59.89
05E30	1S/40	40mm..05E29 1S/40E...\$64.99

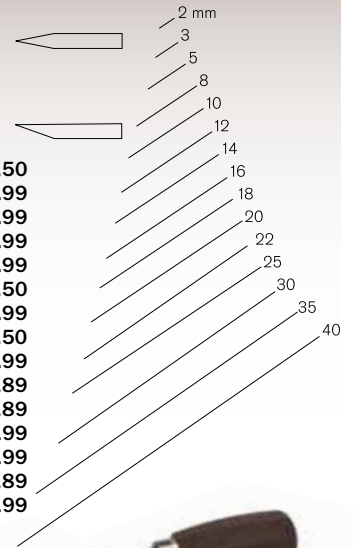

Octagonal Replacement Handles

The traditional octagonal shape of these handles provides a positive grip for controlling cuts in woodcarving and because of the flats, they do not roll. Made of unfinished European hardwood. 5¾" long, handling instructions included.

	A	B	
05X01	9/16"	3/4"\$9.99
05X02	5/8"	7/8"\$10.49
05X03	11/16"	15/16"\$11.99
05X04	13/16"	11/16"\$12.99

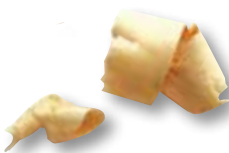

PFEIL Swiss Made® Abegglen Detail Knives

These unique detail knives are a resurrection of a lost, or little known, antique carving tool. Named after a Swiss family, these knives feature dual convex and concave edges that converge to a single point. The 4" shaft and smaller handle means you'll be able to carve into hard to reach areas. Like all Swiss made tools, these follow Pfeil's legendary quality formula of a special grade of hardened chrome vanadium steel that is ground and polished to a razor sharp edge. Approximate blade width is 3/8" for the small, 1/2" medium, 3/4" large. Overall length is approximately 7½". Natural oil finished octagonal Acacia handle.

05B49	Ab G	large	\$49.99
05B50	Ab M	medium	\$49.99
05B51	Ab K	small	\$49.99



V-PARTING TOOLS

Forged and precision ground with straight sides and vee-bottom edge. Principal uses include outlining, rounding over edges with the straight side, adding detail, textures to backgrounds, undercutting, and applying decoration in chip carving. See Sweep Diagrams for tool profiles.



#12 Sweep V-Parting Tools

05J04	12/1	1mm\$42.99
05T75	12/2	2mm\$42.50
05J05	12/3	3mm\$41.99
05T81	12/4	4mm\$43.50
05J06	12/6	6mm\$41.99
05T85	12/8	8mm\$45.99
05J07	12/10	10mm\$46.99
05F34	12/12	12mm\$49.99
05H14	12/14	14mm\$59.99
05I12	12/20	20mm\$84.99

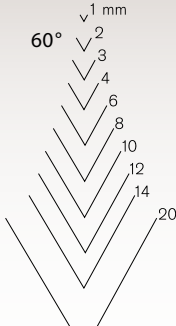

#14 Sweep V-Parting Tools

05F36	14/2	2mm\$44.99
05H16	14/4	4mm\$37.99
05H17	14/6	6mm\$42.99
05H06	14/8	8mm\$47.29
05H07	14/10	10mm\$50.39
05H08	14/12	12mm\$51.49
05F50	14/14	14mm\$53.59
05H11	14/20	20mm\$74.59

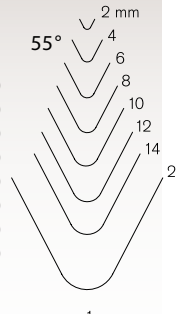

#15 Sweep V-Parting Tools

05E44	15/1	1mm\$43.50
05P07	15/3	3mm\$44.99
05P08	15/6	6mm\$45.25
05F37	15/8	8mm\$47.99

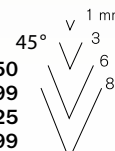

#16 Sweep V-Parting Tools

05E45	16/1	1mm\$49.50
05H18	16/3	3mm\$52.99
05H19	16/6	6mm\$59.99
05F38	16/8	8mm\$54.50

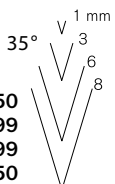

#13 Sweep V-Parting Tools

05T91	1mm\$33.59
05T95	2mm\$33.59
05H03	3mm\$39.99
05V41	4mm\$40.99
05H04	6mm\$47.99
05T61	8mm\$47.50
05H05	10mm\$45.99
05F35	12mm\$44.99
05H09	14mm\$54.99
05H15	20mm\$70.39
05H12	30mm\$99.99

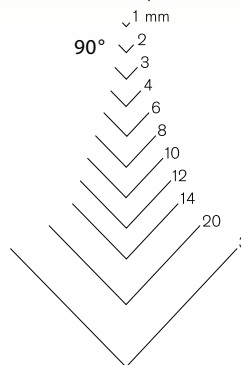

VEINERS

These gouges are more "U"-shaped than any other sweep. They are well-suited to fluting and preliminary outlining of relief carvings. Their shape allows them to make a clean, deep cut in one pass without fear of the corners of the tool digging in. See Sweep Diagrams for tool profiles.



#11 Sweep Veiners

123012	.5mm\$36.99
05I05	11/1	1mm.....\$35.99
05I13	11/1.5	1.5mm \$38.50
05I06	11/2	2mm\$41.50
05I07	11/3	3mm\$40.99
05T51	11/4	4mm.....\$44.50
05I08	11/5	5mm\$42.50
05I09	11/7	7mm\$42.99
05I10	11/10	10mm ..\$48.50
05F33	11/12	12mm ..\$49.99
05I11	11/15	15mm ..\$51.50
05J01	11/18	18mm ..\$49.99
05F64	11/20	20mm ..\$52.25
05J02	11/25	25mm ..\$62.99
05J03	11/30	30mm ..\$68.29

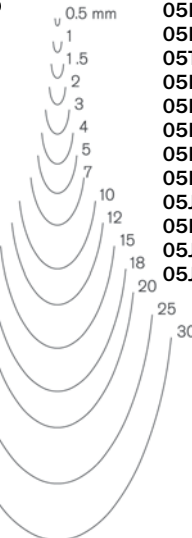

Deluxe Canvas Tool Rolls, see page 101

MACARONI TOOLS

A multi-purpose tool with three working edges, sides forged obliquely to the bottom edge, and ground with an outside bevel. Functions as a chisel and V-parting tool making it possible to follow sweeping inside and outside curves and to remove shallow backgrounds in relief carving.



#23 Sweep Macaroni Tools

05F95	23/4	4mm\$44.99
05G25	23/6	6mm\$41.99
05P02	23/8	8mm\$52.50
05P03	23/12	12mm\$59.99

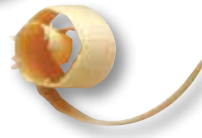
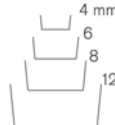

FLUTERONI GOUGES

With three working edges, only the sides are forged at a slight angle to the bottom creating a small radius on each side of the cutting edge. Functions as both a flat sweep and deep sweep gouge.



#24 Sweep Fluteroni Gouges

05F96	24/4	4mm\$45.99
05F13	24/6	6mm\$44.99
05F14	24/8	8mm\$46.99
05F15	24/12	12mm\$49.39



BACK BENT GOUGES

With the curve reversed so the cutting edge is convex instead of concave. Used for carving or cleaning out the underside of a carving or cut. For getting a clean cut where top clearance is restricted. A specialized carving tool, but very useful. See Sweep Diagrams for tool profiles.



#20 Sweep Back Bent Gouges

05F70	20/6	6mm\$42.50
05F71	20/10	10mm\$42.50
05F72	20/13	13mm\$39.99
05F77	20/20	20mm\$39.99
05F82	20/30	30mm\$47.29

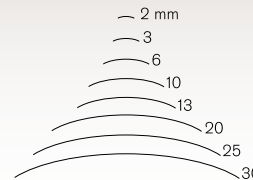
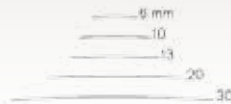

#28 Sweep Back Bent Gouges

05R07	28/6	6mm\$43.99
05R08	28/10	10mm\$45.99



#25 Sweep Back Bent Gouges

05J12	25/2	2mm\$36.79
123010	25/3	3mm\$39.99
05J08	25/6	6mm\$46.50
05J09	25/10	10mm\$47.99
05J10	25/13	13mm\$52.50
05J11	25/20	20mm\$47.29
05J13	25/25	25mm\$48.29
05J14	25/30	30mm\$49.39

BENT TOOLS

Similar to parting tools at the cutting edge, but formed with a short lengthwise bend, like spoon gouges. Use where straight shank standard tools would be awkward.



#12 Sweep Bent V-Parting Tools

05F60	12A/1	1mm\$42.99
05I02	12A/3	3mm\$40.99
05F61	12A/6	6mm\$44.99
05I04	12A/8	8mm\$49.99

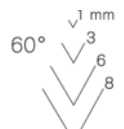

INTERMEDIATE CARVING TOOLS

PFEIL Swiss Made® Intermediate Carving Tools

Specially forged for Woodcraft, these intermediate size, professional-style tools are 2" shorter than our regular Pfeil Swiss made tools for easier control and greater responsiveness. They are carefully sharpened, honed, and buffed for immediate use. The combination of high-grade tool steel and precise tempering results in an edge that will stay sharp for many enjoyable hours of woodcarving. Beginning carvers will find these delicately balanced tools well-suited to their needs, and experienced carvers often prefer them for getting into confined areas. 8" overall length with 3 1/2" blades and 4 1/2" octagonal hardwood handles.

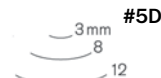
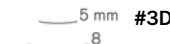
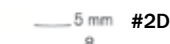
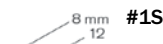

1 Intermediate

Double Bevel Gouges

- 05Q01 1/8D 8mm straight * ..\$27.99
- 05Q02 1S/8D 8mm skew **.....\$31.50
- 05E70 D1/12 12mm straight\$31.99
- 05E71 D1S/12 12mm skew.....\$32.99

2 Intermediate Gouges

- 05E59 D2/5 5mm.....\$34.99
- 05E60 D2/8 8mm.....\$38.99
- 05Q17 D2/12 12mm †.....\$37.99

3 Intermediate Gouges

- 05E61 D3/5 5mm.....\$33.59
- 05E62 D3/8 8mm.....\$35.99
- 05E67 D3/12 12mm..\$35.99

5 Intermediate Gouges

- 05Q03 5/3D 3mm **.....\$29.99
- 05Q04 5/8D 8mm *.....\$34.99
- 05Q16 D5/12 12mm †.....\$35.25



7 Intermediate Gouges

- 05Q13 D7/4 4mm†.....\$35.99
- 05E63 D7/6 6mm.....\$32.99
- 05E64 D7/10 10mm.....\$33.99
- 05Q14 D7/14 14mm †.....\$35.50

7 Intermediate Bent Gouge

- 05Q15 D7L/10 10mm †.....\$35.50

8 Intermediate Gouges

- 05E65 D8/4 4mm.....\$32.99
- 05Q05 8/7D 7mm **.....\$34.99
- 05Q18 D8/10 10mm †.....\$37.99

5 Intermediate Spoon Gouge

- 05E69 D5a/8 8mm.....\$35.50

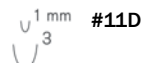

8 Intermediate Spoon Gouge

- 05Q10 8A/7D 7mm * ..\$37.99

9 Intermediate Gouges

- 05E66 D9/2 2mm.....\$36.99
- 05Q06 9/5D 5mm **.....\$35.50
- 05Q07 9/10D 10mm * ..\$38.50

11 Intermediate Veiners

- 05Q08 11/1 D 1mm **...\$37.99
- 05Q09 11/3 D 3mm *...\$38.50

12 Intermediate V-Parting

- 05R01 D12/2D 2mm **\$33.99
- 05E51 D12/6 6mm †.....\$34.50
- 05R02 12/8D 8mm *.....\$35.50



14 Intermediate V-Parting

- 05Q22 D14/6 6mm..\$33.50

15 Intermediate V-Parting

- 05E68 D15/3 3mm..\$37.50

WING V-TOOLS

Similar to V-Parting tools except for the curvature of each side of the vee. This curve softens work by rounding the top of the carved edge. Used for outlining and adding detail, but is particularly useful for carving scripts and other ornamental decorations.

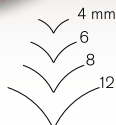

#22 Sweep

Wing Parting Tools

- 05F94 22/4 4mm.....\$60.99
- 05H23 22/6 6mm.....\$62.99
- 05H24 22/8 8mm.....\$64.99
- 05H25 22/12 12mm.....\$66.99

GOUGE SET

PFEIL Swiss Made® Fishtail Gouge Set

Fishtail gouges are designed for use with a mallet and perfect for quick removal of waste and for large scale projects. Like all Swiss made tools, these follow Pfeil's legendary quality formula of the highest grade, hardened steel, polished and ground to a razor sharp edge. Approximate blade length is 5 1/2" with overall length of approximately 11 1/2". Includes 60mm skewed Drayer Gouge, 60mm #2, 60mm #5, and 50mm #7 Fishtail Gouges. Natural oil finished hornbeam handle with heavy duty ferrules.



- 05B48 4-pc. Set.....\$449.99

BEGINNER'S CARVING SET

PFEIL Woodworkers' Class Set

Woodcraft's 10-piece set specifically for beginning carvers: #12 Sweep V-Parting Tool 6mm, #2 Gouge 12mm, #2 Gouge 25mm, #5 Gouge 8mm, #5 Gouge 12mm, #7 Gouge 6mm, #7 Gouge 10mm, #11 Veiner 1.5mm, #25 Back Bent Gouge 10mm, and #25 Back Bent Gouge 6mm.

- 05114\$334.99



CARVING SETS

Deluxe Canvas Tool Rolls, see page 101



A



B

PFEIL Swiss Made® Intermediate Carving Sets

(A) Complete set includes tools marked (*) and (**) and includes an 08G08 8 1/2 ounce Brienz carving mallet; 08Y22 and 08Y32 hard and soft Arkansas stones; and 09L11 15-pocket tool roll.

(B) 12-Piece Intermediate Set profiles are among the most basic and useful in woodcarving: 8mm chisel; 8mm skew; 3mm and 8mm No. 5 gouges; 7mm No. 8 gouge; 5mm and 10mm No. 9 gouges; 1mm and 3mm veiners; 7mm No. 8 spoon gouge; plus 2mm and 8mm No. 12 V-parting tools. Includes tool rack shown above.

- 13D15 (A) complete set.....\$409.99
- 05B59 (B) set of 12 tools.....\$324.99

6-Piece Intermediate Sets. Due to customer demand, the 12-pc. set above has been broken down into two 6-pc. sets. Sets include those tools marked as shown.

- 05H02 set of 6 tools * Save!.....\$159.99
- 05H10 set of 6 tools ** Save!\$164.99
- 05H13 (C) set of 6 tools, Set includes: 12mm No. 2 gouge, 12mm No. 5 gouge, 4mm No. 7 gouge, 14mm No. 7 gouge, 10mm No. 7 bent gouge, 10mm No. 8 gouge.....\$169.99

Set of 7 Intermediate Tools contains profiles not available in the sets described above. (†)

- 05Q20 (D) set of 7 tools Save!\$194.99

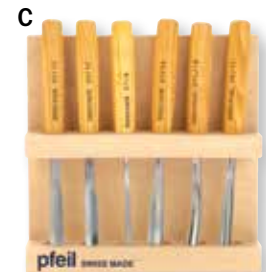

C



D

CARVING SETS



Deluxe Canvas Tool Rolls, see page 101

PFEIL Swiss Made®

Intermediate Sized Starter Set Of 4 Tools

Specially forged for Woodcraft, these intermediate sized, professional style tools are 2" shorter than our regular Swiss tools for easier control and greater responsiveness. Made of tempered high-grade steel, these precise tools are sharpened, honed and buffed for immediate use with an edge that will stay sharp for many enjoyable hours of woodcarving. These delicately balanced tools work well for accessing confined areas. The overall length is 8" with 3 1/2" blades and 4 1/2" octagonal hardwood handles. The tool set includes: 6mm #12 V-Parting Tool, 7mm No. 8 Gouge, #1 18mm Double Bevel Straight Chisel and a 36mm Chip-Carving Knife.

05V21\$109.99

PFEIL Swiss Made® Brienz Collection Carving Set

If you want to own the finest carving tools in the world, this is the set for you. The Swiss carving tools in this premiere, set were chosen in collaboration with Mr. H. P. Stähli, Master Woodcarving Instructor at the world renowned Kantonale Schnitzerschule Brienz woodcarving school in Brienz, Switzerland. Tool set includes: #1 Straight Chisel 16mm, #1 Skew Cut Chisel 16mm, #2 Gouge 20mm, #3 Gouge 3mm, #3 Gouge 12mm, #3 Gouge 25mm, #5 Gouge 35mm, #7 Gouge 20mm, #8 Gouge 7mm, #8 Gouge 18mm, #8 Gouge 25mm, #8 Spoon Gouge 18mm, #7 Heavy Bent Gouge 25mm, #9 Gouge 7mm, #9 Gouge 15mm, #11 Veiner 2mm, #11 Veiner 10mm, #15 V-Parting Tool 3mm, #12 V-Parting Tool 10mm, #14 V Parting Tool 8mm, and a Brienz Carver's Knife. In addition to these 21 Swiss carving tools, the complete set includes a 14 1/2 oz. beech carving mallet, a No. 1 and a No.2 Arkansas honing stone, and one 4 ounce container of sharpening oil, all conveniently packaged in a rugged pfeil canvas storage roll.

05B58\$974.99



PFEIL Swiss Made®

Brienz Intermediate Set

Following the introduction of the Swiss Brienz Collection, we had many requests for a similar boxed set in the Swiss Intermediate carving line. We are happy to introduce a boxed, 18-piece Swiss Intermediate carving tool set which not only includes the 12 tools of the original set (05H01), but also includes 6 new profiles never offered before. The new profiles featured in this boxed set are a 4mm #7 Gouge, 14mm #7 Gouge, 10mm #7 Bent Gouge, 12mm #5 Gouge, 12mm #2 Gouge, and 10mm #8 Gouge. The remaining 12 profiles are 8mm Straight Chisel, 8mm Skew Chisel, 3mm #5 Gouge, 8mm #5 Gouge, 7mm #8 Gouge, 5mm #9 Gouge, 10mm #9 Gouge, 1mm #11 Veiner, 3mm #11 Veiner, 7mm #8 Spoon Gouge, 2mm #12 V-parting, and 8mm #12 V-parting. The lacquered beech box has a sliding top, with individual tool compartments for each tool.

05Q21\$599.99



PFEIL Swiss Made® Brienz Professional Carving Sets

Twelve superior quality carving tools, preferred by professionals for the most demanding projects. Blades of polished tool steel are precision-tempered, ground and sharpened at the factory for immediate use. Octagonal, non-slip, non-rolling European hardwood handles. 12-piece Set includes: #1 Straight Chisel 8mm, #1 Skew Chisel 8mm, #5 Gouge 8mm, #5 Gouge 20mm, #7 Gouge 6mm, #7 Gouge 14mm, #7 Heavy Bent Gouge 20mm, #8 Gouge 4mm, #8 Spoon Gouge 10mm, #9 Gouge 10mm, #11 Veiner 3mm, #12 V Parting Tool 6mm, overall length of tools is 10". Complete set comes with deluxe canvas tool roll containing individual pockets for each tool, soft Arkansas multiform slipstone for preliminary sharpening, hard Arkansas multiform slipstone for final finishing, and a 14 1/2 ounce beech Brienz mallet with 3 1/8" diameter head. Set is over \$419 in value!

05B57 (A) Swiss Brienz 12-piece, includes tool roll\$429.99

13F10 (B) complete set with mallet, slipstones and tool roll **Save!**\$499.99

PFEIL Swiss Made®

6-Piece Professional Set Made up of the most popular tools from our set of 12 this great starter 6-piece set includes: 8mm straight chisel, 12mm No. 5 gouge, 10mm No. 7 gouge, 10mm No. 9 gouge, 3mm No. 11 veiner and 6mm No. 12 V-parting tool, overall length of tools is 10". Other tool sizes and shapes, may be added later to suit your type and style of work.

05W20 6-piece Set only **Save!**\$184.99



Technical Questions?

Call 1-800-535-4486
For FREE help, and advice!



SCULPTOR'S SET



Laser Engraving Available

PFEIL Swiss Made® Sculptor's Set

Includes the six most useful sizes and styles for three-dimensional figure carving. The steel blades will take the hard use necessary for roughing out a block and hold the razor-sharp edge vital to a clean, crisp surface. Set includes 30mm chisel; 30mm skew; 30mm No. 5 gouge; 30mm No. 7 bent gouge;

35mm No. 9 gouge; and 20mm No. 12 V-parting tool; 4" diameter head, 23½ oz. beech Brienz mallet, and 15-pocket canvas tool roll.

13G10 complete set, above **Save!**..... **\$399.99**

13G20 6-piece set, tool roll sol. separately **Save! \$324.99**

CHIP CARVING KNIVES



PFEIL Swiss Made® Chip Carving Knives

The superb quality of our exclusive pfeil Swiss made tools is also available to chip carvers. This set of knives was designed especially for chip carving, but is also useful for whittling, carving, and even layout work. Forged of special alloy tool steel, blades hold their edge longer than most other knives of this type. Pre-sharpened for immediate use. Overall lengths between 5¼" to 7½". Rc 57-60 hardness.

05Z10	chip carving set (B & I).....	\$29.99
05Z20	whittler's set (A, G, K & L).....	\$69.99
05Z11	A, #1.....	\$22.50
05Z21	B, #2.....	\$18.50

05Z31	C, #3.....	\$17.50
05Z41	D, #4.....	\$20.99
05Z51	E, #5.....	\$21.99
05Z61	F, #6.....	\$24.19
05Z71	G, #7.....	\$17.50
05Z81	H, #8.....	\$19.99
05Z91	I, #9.....	\$21.99
05Z95	J, #10.....	\$19.49
123011	K, #11.....	\$26.79
123014	L, #12.....	\$23.50
05Z93	M, #13.....	\$32.50
05F97	N, #15.....	\$29.99

SCORPS



PFEIL Swiss Made® Scorsps

A roughing-out tool for making bowls, spoons, and similar concave shapes. The comfortable hardwood handle can be gripped firmly for quick, accurate cuts. The thick shank reduces chatter and increases accuracy. Width of offset blade 1¼", 7" overall length. Honing required before use.

11V51 Renette (A).....**\$48.99**

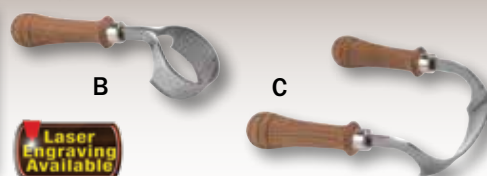

These scorsps, or inshaves follow pfeil's legendary quality formula - a special hardened alloy of chrome-vanadium steel, ground and polished to a razor sharp edge, ready to use right from the box.

Single handle has 2½" diameter, 1¼" wide blade.
05B55 Scorp 65 (B) 65mm, single handle..... **\$96.99**

Double handle has 5" flattened radius cutting face. Both feature 5" natural oil finished Cherry handles.
05B56 TH Scorp (C) 160mm, double handle **\$104.99**

Laser Engraving Available

STARTER SET



PFEIL Swiss Made®

Full-Size Starter Set

This is an ideal selection for the beginning carver who wants a basic set of full-sized but commonly used tools. Everything you need to get started is here, including a heavy-duty, fitted tool roll to hold and protect your tools. Set includes: 12mm No. 1 single-bevel straight chisel; 12mm No. 1 skew cut double-bevel chisel; 12mm No. 5 gouge; 20mm No. 4 gouge; 10mm No. 7 gouge; 4mm No. 9 gouge; 8mm No. 12 V-parting; #12 chip carving knife.

05E50 **\$289.99**

DRAW KNIVES

PFEIL

Swiss Made®

Drawknives

Finely machined from the best alloy tool steel, each drawknife is shaped to give optimum control when shaping blanks or making critical finishing cuts. Feature hand-turned nonslip cherry handles; ample finger space around blades for safe holding during use; pre-sharpened, single-beveled cutting edges to shear wood effortlessly and rehone easily. Exceptional tools.

Straight Drawknife. Blade 5" long x 7/8" wide, overall length 12½".

05T11 ZUGG..... **\$68.99**

Carver's Drawknife. Blade 4½" long x 7/8" wide.

05T12 ZUGA..... **\$81.99**

Large Carver's Drawknife. Blade is slightly convex, 9½" long x 1" wide, 17" overall. Includes leather sheath.

05Z03 ZUGCD..... **\$134.99**

ADZES AND HATCHET



Forged

Carving Adzes And Hatchet

These forged tools from pfeil are perfect for those large carving or timber framing projects and feature the same attention to detail and high quality as our world famous Swiss made carving tools. Premium tool steel is hardened to 56-58 Rc to create a durable, resilient cutting edge, which stays sharp longer. All tools feature "through eye" forging and come handled, ready for use. Solid ash handles are unfinished. Austria.

Carving Hatchet has a 5" cutting edge with an overall tool length of 18".

05Z98 AXT..... **\$144.99**

Straight Head blade is 3" wide; overall tool length is 18".

05Z96 FLACH D..... **\$139.99**

Curved Head blade is about 2½" across, with a curve that approximates a #9 sweep carving tool profile. Overall tool length is 18".

05Z97 HOHL D..... **\$163.50**

Small Curved Head adze's blade is about 2" across, also with a curve that approximates a #9 sweep. Overall tool length is 11". The tool's smaller size makes it a perfect bowl adze.

05Z99 HOHL KLEIN..... **\$168.99**

PALM HANDLED CARVING SETS



05E58



PFEIL Swiss Made® Palm-Handled Carving Sets

Designed for wood block carving, yet furniture-makers and decoy carvers like their 4¾" length for delicate, intricate work. Hardwood handles fit the palm of your hand so your fingers can guide and control the action of the razor-sharp blade. Half-round handles make long, low cuts easier and prevent the tools from rolling off your workbench.

6-Piece Swiss Palm Sets*

6-Piece Palm Set A includes 8mm chisel; 8mm skew; 8mm bent chisel; 8mm No. 5 gouge; 3mm No. 11 veiner; 4mm No. 12 bent V-parting tool.

05P01 set (A) Save!..... \$144.99

6-Piece Palm Set B** Includes: 3mm No. 5 gouge; 6mm No. 7 gouge; 10mm No. 7 gouge; 5mm No. 9 gouge; 1mm No. 11 veiner; 1mm No. 12V-parting tool.

05V11 set (B) Save!..... \$144.99

6-Piece Palm Set C. Includes: 2mm No. 15 V-parting; 4mm No. 12 V-parting; 0.5mm No. 11 veiner; 2mm No. 9 gouge; 7mm No. 8 gouge; 3mm No. 8 gouge. Sorry, not available individually.

05Y75 set (C)..... \$174.99

6-Piece Palm Set D. Includes: 4mm No. 1 chisel; 4mm No. 1 skew chisel; 5mm No. 5 gouge; 4mm No. 7 gouge; 7mm No. 8 gouge; 2mm No. 11 veiner. Sorry, not available individually.

05E58 set (D)..... \$139.99

12-Piece Palm Set includes all tools of Set A and B above plus a 12-place storage rack.

05Y70 12-pc. set Save!..... \$299.99

05Y71 12-place storage rack..... \$52.99

8-Piece Swiss Palm Sets

8-Piece Palm Set A* Includes: 8mm No. 12V-parting, 10mm No. 9 gouge, 10mm No. 8 bent gouge, 14mm No. 7 gouge, 12mm No. 5 gouge, 12mm No. 3 gouge, 12mm No. 1 gouge, 12mm No. 1 skew chisel. Sets include an 8-place wood storage rack.

05Y10 8-piece palm set (A) Save!..... \$229.99

8-Piece Palm Set B includes the following eight tools: 12mm No. 2 gouge, 12mm No. 4 gouge, 12mm No. 7 bent gouge, 10mm No. 8 gouge, 7mm No. 9 gouge, 7mm No. 11 gouge, 6mm No. 15 V parting, 10mm No. 25 back bent gouge. Sorry, not sold as individual tools.

05F98 8-piece palm set (B)	\$229.99
05D01* 8mm chisel.....	\$29.99
05R09* 8mm skew	\$29.99
05T41* 8mm bent chisel	\$30.99
05X11* 8mm No. 5 gouge	\$30.99
05Y12* 3mm No. 11 veiner	\$30.99
05Y22* 4mm No. 12 bent V.....	\$30.99
05Y32** 3mm No. 5 gouge.....	\$29.29
05Y42** 6mm No. 7 gouge.....	\$29.29
05Y52** 10mm No. 7 gouge.....	\$29.29
05Y62** 5mm No. 9 gouge.....	\$30.99
05Y82** 1mm No. 11 veiner	\$30.99
05Y92** 1mm No. 12 V-parting	\$30.99
05Y01* 8mm No. 12 V-parting	\$32.49
05Y02* 10mm No. 9 gouge.....	\$32.49
05Y03* 10mm No. 8 bent gouge.....	\$32.49
05Y04* 14mm No. 7 gouge.....	\$32.49
05Y05* 12mm No. 3 gouge	\$30.59
05Y06* 12mm No. 5 gouge	\$30.59
05Y07* 12mm No. 1 gouge.....	\$30.59
05Y08* 12mm No. 1 skew chisel	\$30.59
05Y90* 8-place storage rack.....	\$36.79

Replacement Palm Tool Handle of unfinished European hardwood.

05Y99 extra handle..... \$9.99



A

B

Book and sharpening stones not included in sets.

SCULPTOR'S SET



RAMELSON Carving Tools

These tools feature hardwood handles with a metal ferrule. Comfortable 6¼" to 6½" lengths make them easy to control for detail carving. Factory-sharpened and ready for use. Made in the USA of high-carbon tool steel.

127159 12 tools, only Save!..... \$142.50

127145 ¼" No. 9 gouge..... \$20.99

127146 5/16" No. 8 gouge..... \$19.99

127147 3/8" skew..... \$19.99

127148 3/8" No. 7 gouge..... \$23.99

127149 3/8" chisel..... \$21.99

127150 ¼" V-parting..... \$22.99

127151 (A) set of 6 tools above..... \$99.99

127152 3/8" No. 9 gouge..... \$20.75

127153 3/8" No. 5 fishtail gouge..... \$20.99

127154 ½" No. 5 fishtail gouge..... \$18.99

127155 ¼" No. 9 gouge, deep..... \$19.99

127156 5/32" V-parting..... \$22.99

127157 5/32" U-veiner..... \$19.99

127158 (B) set of 6 tools above..... \$97.99

PFEIL Swiss Made®

Drake Undercutting Tools

Designed especially for relief carving. The shape and size of the cutting edge allows precise and controlled undercuts in hard to access areas.

05X21 undercutting tool left..... \$44.99

05X22 undercutting tool straight..... \$44.99

05X23 undercutting tool right..... \$44.99

Deluxe Canvas Tool Rolls, see page 101



A



B



C

RAMELSON Beginner's Carving Tools

These quality carving tools are made in the USA of W-1 U.S. Tool Steel and feature comfortable 6¼" to 6½"-long hardwood handles with metal ferrules that make them perfect for doing simple or detailed work. Three sets of six tools each are available: The original Beginner's set, as well as the new Mini and Micro sets with smaller profiles to enable them to do even more detailed work - all factory ground, factory sharpened and ready for use. The Complete Set includes all 18 tools.

Ramelson Beginner's 6-piece Carving Set:

3/8" bent chisel, 3/8" skew, 3/8" straight chisel, 9/64" gouge, 5/16" bent gouge and 9/64" bent V-parting tool.

14121 (A)..... \$56.50

Ramelson Beginner's Mini 6-piece Carving Set:

7/32" bent chisel, 7/32" skew, 7/32" chisel, 1/8" veiner, 1/4" bent gouge and 1/8" bent parting tool.

159191 (B)..... \$57.50

Ramelson Beginner's Micro 6-piece Carving Set:

11/64" bent chisel, 11/64" skew, 11/64" chisel, 3/32" veiner, 1/8" gouge, and 3/32" bent parting tool.

159192 (C)..... \$4.99

Ramelson Beginner's Complete 18-Piece Carving Tools Kit

159193 (A, B, C)..... \$139.99

Carving



Deluxe Canvas Tool Rolls, see page 101



FLEXCUT® C

Specialty Carving Knives

Flexcut offers carvers a unique range of carving knives with high carbon steel blades that are carving-sharp right out of the package. They're designed to perform beyond your expectation and to enhance the carving experience.

FLEXCUT® Detail Skew Knife

The Detail Skew Knife is great for carving detail, feathers, cleaning stop cuts, and making vertical cuts where space is limited. The extended shank helps for a deeper reach of the blade. New handle shape holds like a pencil or conventional knife. Blade cutting edge is 9/16" long.

158154 (A).....\$27.99

FLEXCUT® Mini Detail Knife

The Mini Detail Skew Knife is great for carving eye detail, feathers, cleaning stop cuts, and making vertical cuts where space is limited. The extended shank helps for a deeper reach of the blade. New handle shape holds like a pencil or conventional knife. Blade cutting edge is 3/8" long.

158155 (B).....\$26.99

FLEXCUT® Upsweep Knife

The Upsweep Knife is used for incising and carving detailed designs. The curved blade is easier for carving and shaving. The knife handle is crafted from white ash and is ergonomically designed to allow a strong grip for long periods of carving with minimal hand fatigue. Cutting edge is approximately 1 1/4" long.

158156 (C).....\$24.99



FLEXCUT® Knives

Made with Flexcut's high-quality spring steel, tempered to a hardness of Rc59-61, and fitted with tremendously comfortable ash handles, these knives perform as marvelously and hold an edge as well as Flexcut carving tools. There's a knife for every cutting and shaping application. Presharpened for immediate use.

- 814266 (A) cutting knife \$22.50
- 814267 (B) detail knife \$23.99
- 814268 (C) large cutting knife \$23.50
- 814845 (D) chip carving knife \$21.99
- 836554 (E) right hand hook knife \$29.99
- 147461 (F) mini detail knife..... \$26.99
- 814265 (G) skew knife \$18.99
- 820598 (H) pelican knife..... \$29.99



FLEXCUT® Knife Strop™

Finally, Flexcut® has a Knife Strop™. Now all the Flexcut and other knife users can enjoy the same benefits that palm tool users do with the Flexcut SlipStrop (143657). The Knife Strop comes with Flexcut® Gold Polishing Compound™ and is the ideal way to keep your knife blade razor-sharp between touches to a stone. Just apply a little compound to the strop by rubbing and a few strokes of the knife to the strop, and you're back to carving.

159016\$13.99

FLEXCUT®

Deluxe Knife Set With Free Tool Roll

Flexcut has built a reputation for value and quality the equal of any manufacturer anywhere. Their knives are comfortable to hold, easy to sharpen, hold an edge and cut like nobody's business. Now imagine 18 of these fine knives in a storage box with a free travel tool roll. That's an almost overwhelming deal, but it's what you get in this Flexcut set that will provide a lifetime of carving pleasure. Set includes the following knives: KN11, KN12, KN13, KN14, KN15, KN18, KN19, KN20, KN26, KN27, KN28, KN31, KN32, KN33, KN34, KN35, KN36 and KN37.

158793\$357.99



B

A

FLEXCUT® Micro Tool Sets

Flexcut's new line of micro tools is designed to handle the extra fine details often encountered in woodcarving. These new tools are perfect for detailing, cleaning up ridges, cleaning up corners and adding those finishing touches to your carvings. Each set is made up of four tools with one each of the following sizes: 1/16", 1/8", 3/16" and 1/4". Set comes with a free tool roll offer from Flexcut inside.

159735 (A) skew set\$60.99

159736 (B) chisel set..... \$60.99



FLEXCUT® 3-Piece Knife Starter Set

Made from Flexcut's high quality spring steel, tempered to a hardness of Rc59-61, and fitted with comfortable, ergonomic ash handles. Each tool approximately 6 1/2" in length and is pre-sharpened and ready to use. Set contains one each of; cutting knife, detail knife, and roughing knife.

151121 set KN500..... \$54.99



FLEXCUT® Whittlin' Jack

Flexcut's Whittlin' Jack is a smaller 2-blade version of the original Carvin' Jack. Its design features the two blades any carver could need. At 3 ounces and with a closed length just over 4", you will hardly even notice it in your pocket. Whittlin' Jack includes a detail Knife (1 1/2" long) and a roughing-knife (2" long). Carry it with you, and you'll never be caught without whittlin' tools again!

850931 \$50.50

FLEXCUT® Starter Kit

Bonus: FREE Relief Carving DVD!

A complete carving set all in one box. Seventeen cutting tools, two interchangeable handles and a SlipStrop to keep them all sharp! Everything you need for mallet, palm or knife carving. Set includes a 5/8" #1 chisel, 9/16" #2 skew, 1/4" and 7/8" #3 gouges, 1/8" #5 gouge, 1/2" #6 gouge, 1/4", 3/8" and 1 1/16" #8 gouges, 9/16" #9 gouge, 1/16" #11 gouge, 3/16" and 1/2" #11X thumbnail gouges, 5/32" 45° V-tool, 3/8" 70° V-tool, 7/8" back bent gouge, cutting knife, ABS quick-connect palm handle, quick-connect Power Handle, SlipStrop and compound. All neatly packed in a wooden storage case. Also includes the DVD *Relief Carving In A Different Light* by David Bennett. A \$14.95 value, yours FREE!

146913 set SK108 \$206.99



FLEXCUT® Carvin' Jack

Carry a complete carving kit in your pocket! The blades of this unique carving tool fold into their handle just like a pocket knife's blades. Professional carvers will love the high quality edge-holding features of Flexcut's resilient spring-steel blades. The Carvin' Jack features six tools: 3/4" #7 sweep knife blade; 3/8" #6 scorp; 3/8" #11 gouge; 3/8" #1 straight chisel; 1 3/8" detail carving knife; 1/4" 70° V scorp. All tools securely lock in both opened and closed positions. Conveniently sized at only 4 1/4" long, 15/16" tall, and 5/8" thick when closed, about the same size as a large pocket knife. Carry it with you, and you'll never be caught without carving and whittling tools again! Flexcut's Pocket Jack weighs 3 ounces with a closed length of 4 1/4". Includes the following blades: detail knife (1 5/8" long), straight gouge (1 7/8" long), scorp (1 1/16" long) and v-scorp (1" long).

145445 right-hand model \$129.99

145485 left-hand model \$129.99



FLEXCUT® Carving Tool 4-Piece Set With Tool Roll

Flexcut has combined the four most popular carving knives into one set. The set includes a cutting knife, detail knife, pelican knife, mini-pelican knife and tool roll and these knives are made of the same edge holding steel as Flexcut gouges and chisels. Comfortable handles let you carve for extended periods of time without hand fatigue. This set includes a KN1 cutting knife, KN13 detail knife, KN18 pelican knife, KN19 mini-pelican knife and tool roll.

836194 \$81.99

1/4 HP Flexible-Shaft Carver Kit

Tackle a complete range of projects with this heavy-duty Power Carving Kit – from fine detail work with smaller burrs to roughing-out at a much greater speed than you could with less powerful motors. And, the powerful 1/4 hp motor is reversible – a bonus for left-handed carvers. This carver has a super flexible 42" shaft that does not require lubrication, eliminating the messy chore of disassembling and greasing the shaft. The kit includes a 1/4 HP, 20,000 rpm motor, variable-speed heavy-duty foot control pedal, standard rotary handpiece, 3 collets (3/32", 1/8", 1/4"), wrench, and tool hanger. 120V.

- 147220 1/4 HP carving kit..... \$219.99
- 147221 outer sheath..... \$16.99
- 147222 cable..... \$15.99
- 147223 motor brushes for WE-330R..... \$7.50

Accessories:

Foot-Operated Speed Control. Regulates motor speed, leaving hands free to hold tools and workpiece. Can be used with most flexible-shaft kits. Cord length is 74".

- 147226 (A) \$47.29

Motor Hanger

With just the twist of a knob, you can clamp this hanger to your work surface. Since the sturdy post is comprised of 3 rigid-steel tubes that screw together, you can also vary the height of the hanger from 13" to 40".

- 147225 \$28.50



Standard Handpiece

Provides great control for detail work and makes it easy to get into hard-to-reach areas. This ergonomic handpiece fits comfortably in your hand because of its tapered end. Comes with 3/32", 1/8", 1/4" collets and wrench.

- 147231 standard handpiece..... \$52.50
- 147233 1/8" collet..... \$7.99
- 147234 1/4" collet..... \$7.99



Detail Handpiece

This small, lightweight handpiece features a 9/16" diameter body so you can hold it like a pencil for your fine detailing. Comes with 1/8" and 3/32" collets and collet wrench. 4 1/2" overall length. Fits most flexible-shaft tools.

- 147228 \$47.99



Carving Handpiece

Convert your flexible shaft tool to a reciprocating carver. Includes a 1/4" 90 degree V-chisel, 3/8" #9 gouge, 3/8" straight chisel, 3/8" round nose chisel, 5/16" straight chisel, and flexible shaft carving tools. 5 1/2" overall length, 1" diameter.

- 147227 \$63.50



Deluxe Canvas Tool Rolls

Heavy canvas rolls are stitched to hold 9, 15 or 25 carving tools or chisels. The edges of the rolls are sewn banded to prevent fraying. Rolls feature a large end flap with cotton tie that firmly closes the roll to prevent your tools from slipping out. For tools under 12" in length.

- 02L11 9-pocket roll \$25.99
- 09L11 15-pocket roll \$31.99
- 09L21 25-pocket roll \$34.50



Chip Carver's Tool Roll has 11 pockets for tools up to 8" in length. Top flap completely covers tools when closed. Single row of pockets makes tool selection easier. Holds miniature turning tool sets, too! Not illustrated.

- 02X41 \$22.09



FLEXCUT® Drawknives

Made from the same resilient spring steel as Flexcut's Palm Tools, these carver's drawknives flex in either direction to do round or hollow work. Hand-honed and polished to a razor-edge and perfectly suited for rough or delicate shaping. Fitted with ash handles similar to the Flexcut Palm Tools.

- 814846 5" curved blade \$39.99
- 145370 3" straight blade..... \$44.50

Carver's Spoon Plane

Easy to control and quick cutting and perfect for spoons and bowls it can also be used to smooth the surface of large carvings. Made of cast bronze, then coated with titanium nitrate for a super-smooth finish, the plane features a large comfortable handle for extended use. Plane is 1 3/4" wide, 6 1/8" long, with a 1 3/8" wide blade. Requires honing before use.

- 144822 \$23.09



Power Carving Dust Collector

The two individually controlled fans of this compact, portable unit, draw up to 500 cubic feet of air per minute. This self-contained unit even has dual 115V outlets to power your sanders or power carver. Includes a Plexiglas shield that attaches to the dust collector for increased efficiency. 8" x 10 1/2" x 21".

- 140605 \$244.69
- 09G18 dustless repl. air filter..... \$15.50

ARBORTECH Woodcarvers

Arbortech is a safe and efficient wood carving blade of hardened steel and tungsten carbide. This tool is ideal for shaping, sculpting, trenching, planing, and trimming smoothly, with or



against the grain. The chip limiter, restricts the depth of cut and helps prevent kickback and grabbing. The Pro-Guard affords you the highest level of protection, while allowing a clear view of the blade. The Industrial Pro mounts on 4" or 4 1/2" angle grinders and fits Makita 9504B and 9526PB grinders without the use of adapters. It also fits Bosch 1346A and 1347A; Makita N9504B and 9527PB; and Metabo AG650S. The Mini Grinder fits Hitachi G12SA, Makita 9524NB, 9521NB, 9520NB, 9523NB; and Ryobi SG100. If your grinder is not listed, call and we'll check our chart. Adapters are available that allow the wheels to fit most grinder models.

Industrial Pro Kit includes a 4" Industrial Woodcarver with three sharpenable carbide teeth, Pro-Guard, and adjustment key.

- 128258 industrial pro kit \$164.99
- 128805 repl. carbide teeth (3) \$62.99

Complete Mini Grinder – a powerful 600-watt, right-angle drive rotary grinder. Glass reinforced extension arm gives excellent visibility and strength. Includes extra 2" blade and mini sander assortment.

- 142264 complete mini grinder..... \$256.99
- 128824 2" industrial blade..... \$37.50

ARBORTECH Turbo Plane™

This universal freehand wood shaping tungsten carbide toothed blade can be used in a number of ways to create different profiles and finishes. This Arbortech blade is specifically designed to be laid flat with a rotary planing action. It has no cutting edge on the outer perimeter, which makes it safer and easier to use than other freehand blades.

- 154591 \$164.99



ARBORTECH Power Chisel

A high-powered reciprocating chisel will save you time and reduce fatigue while working on everything from detailed carvings to rough work. The new Arbortech Power Chisel operates at 12,000 strokes per minute providing smooth action and excellent control to make quick work of labor-intensive operations. The powerful 700-watt motor delivers a low vibration and deep penetrating cut. As a safety precaution, the quick-change chisels are only active when pressed into the workpiece. Kit includes: 20mm flat chisel; 20mm No. 7 gouge; and 25ml of lubricant.

The **5-Piece Chisel Pack** includes the following gouges: 20mm No. 3; 12mm No. 5; 13mm No. 9; 7mm No. 11; and an 8mm 60° No. 12.

The **3-Piece Chisel Pack** includes: 7mm No.8; 18mm 90° deep-V; and a 20mm No.9. Blades require honing before use.

- 142273 power chisel kit..... \$259.99
- 142274 5-piece chisel pack \$139.99
- 143178 3-piece chisel pack \$86.99

Power Carving



FOREDOM®

Flexible-Shaft Tools

1/6 HP 5200 SR Deluxe Kit combines the best and most important features in a flexible-shaft tool:

- More Power - 1/6 HP, 33% more power than the Freedom Series S motor.
- Reversible - great for left-handed users.
- Reliable - Two-year manufacturer's warranty. Includes the SCT foot control, No.44T handpiece, 3/32", 1/8" and 1/4" collets, No.28 handpiece with 1/8" and 3/32" collets, safety glasses, plus a 26-piece woodcarver's professional accessory kit. The kit includes purple ceramic sanding bands & discs, V-stones, ScotchBrite radial bristle discs, Typhoon carbide burrs, CeramCut blue stones, rotating burr and bit holder plus a small round burr holder with lid. 0-18,000 RPM.

146886 (A) **\$374.99**

1/3 HP TX Flexible Shaft Kit. From start-up to full speed the TX permanent magnet DC motor delivers more torque torque in the low, medium and full speed range with complete control that makes the TX ideal for lower-speed carving with large burrs. Kit includes TX hang-up motor, No. 44T handpiece with 3/32", 1/8" and 1/4" collets, pin & wrench, woodcarving accessory kit with 12 different grinding tips, spare motor brushes and shaft grease. 0-15,000 RPM.

146888 **\$394.99**

Dremel® Cutting Edge Rotary Tools

Dremel Rotary Tools, along with their attachments and accessories, make carving or household projects more enjoyable and successful.

\$69⁹⁹

Dremel 3000 Rotary Tool
853497



\$49⁹⁹

Dremel VersaTip™ Butane Soldering Torch
159643



See your local Woodcraft Store or visit woodcraft.com For More Dremel and RotoZip Accessories



Power Carving Kit

A high-quality variable-speed motor tool is the centerpiece of this kit that features rotary and reciprocating action, and handheld or flex-shaft carving! The unit features ball-bearing construction, 1/8" collet with shaft lock for easy bit changes, folding bail for hanging the unit, and separate on/off switch and variable speed controls. When used in the hanging mode you can attach either the reciprocating or three-jaw chuck rotary handpieces to the 38" super-flexible shaft. Furnished with a five-piece ruby detailing burr set, two diamond burrs, two straight chisels (3/16" and 3/8"), 3/8" curved chisel, 1/4" V-chisel, and a 3/8" gouge. Complete kit includes handpiece wrench, shaft adapter nut, and form-fitted case. Accepts FLEXCUT™ power carver blades without adapter.

141885 **\$167.50**



Tungsten Carbide Burrs

These revolutionary-styled, patented SSG-structured carbide burrs feature a fast, free-cutting action that works equally well cutting with or against the grain, and even on knots. Clogging caused by highly resinous or fibrous wood can be brushed out or burned off without damaging the teeth. The needle-sharp points of tungsten carbide can be "dressed", just like a grinding wheel, to give an even smoother surface finish. We offer three grits-Gold, which is more of a medium grit burr leaving a surface finish that requires moderate sanding; Silver, which is coarse and fast cutting; Red, whose random spaced carbide has the fastest cutting action with minimum clogging, but leaves a surface that requires further work with finer burrs. These burrs will also cut fiberglass, plastics, rubber, soft stone, or composite materials. Overall lengths from 1 1/2" to 3", maximum RPM 28-30,000.

Our most popular style sets -

Red X Coarse	Silver Coarse	Set Includes	Each
140495	18N20	A, D, E, H.....	\$71.50
N/A	18N30	I, L, N, O.....	\$51.50

All burrs are available individually -

Silver, Coarse	Shank Dia.	Style	Each
18N1A	1/4"	A	\$17.89
18N1B	1/4"	B	\$16.79
18N1D	1/4"	D	\$22.99
18N1E	1/4"	E	\$22.50
18N1F	1/4"	F	\$22.50



Reciprocating Carving Action!

AUTOMACH® Power Carver

Model HCT 30A. The newest advancement in woodcarving technology! The Handcraft Carver is rugged and reliable. Aluminum die-cast body is light and vibration-free. Special reciprocating action of the cutterhead carves through the toughest woods with just simple hand direction. Greater pressure causes a deeper cut. For safety, free-floating action keeps blades motionless until pressed against wood. The laminated blades move at 10,000 vibrations per minute, leaving a smooth cut surface. Carvers appreciate the versatility in portability and movement, as well as accuracy and speed. Powerful 80-watt ball-bearing motor delivers precise 1mm cutting strokes. Includes 6' grounded cord, rear on/off switch, hanger, five blades, two spanner wrenches, and complete instructions for use. Body measures 228mm (9") long x 44mm (1 3/4") diameter, 990 grams (2 lbs.) in weight. UL listed.

09G41 **\$309.99**

High-Torque Carver/Engraver

Ideal for detailing and intricate carving, this powerful high-torque handpiece features variable speed, so you can always be operating at the optimum speed required by your bit or type of stock. At only 6 1/4" long and 1" diameter, it fits comfortably in the hand and is light enough to be held like a pencil. Variable speed: 3,000 to 13,000 RPM. Includes 1/8" and 3/32" collets.

147235 **\$84.99**

Double-Cut Solid Carbide Burr Sets

The fine diamond-like tooth pattern of these carbide burrs cuts very aggressively, yet leaves a surface finish much finer than coarse cutting burrs. Solid carbide heads are brazed to steel shanks. 30,000 RPM maximum. Set of the 8 in a fitted case.

145074 1/4" shank 8-pc. set..... **\$56.50**

145075 1/8" shank 8-pc. set..... **\$56.50**

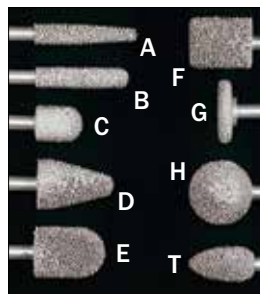

1/4" Shank

Not to Scale

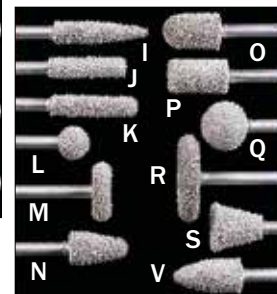

1/8" Shank

Silver, Coarse	Shank Dia.	Style	Each
18N1H	1/4"	H	\$22.99
18N1T	1/4"	T	\$16.79
18N1I	1/8"	I	\$14.50
18N1J	1/8"	J	\$13.69
18N1K	1/8"	K	\$13.69
18N1L	1/8"	L	\$16.79
18N1N	1/8"	N	\$15.79
18N1O	1/8"	O	\$16.29
18N1P	1/8"	P	\$17.29
18N1Q	1/8"	Q	\$17.99
18N1R	1/8"	R	\$18.50
18N1S	1/8"	S	\$17.99
18N1V	1/8"	V	\$17.99

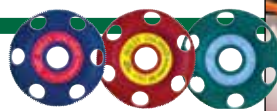
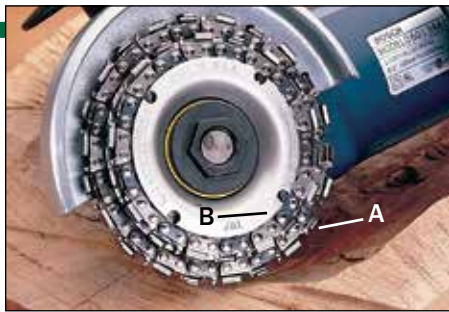

KING ARTHUR Holey Galahad®

These discs provide a unique ability to see the surface you are carving as you work. Holey Galahad quickly allows you to shape peaks and valleys into smooth surfaces as you see them, eliminating the need to "feel" the high and low spots. The extremely sharp, long-wearing conical teeth provide superior surface removal with a very smooth action. Made of durable tungsten-carbide and available in round and flat profiles. Available in coarse, medium and fine grits.

- 149989 round coarse, blue (shown)\$89.99
- 149990 round medium, red (shown).....\$89.99
- 149991 round fine, green (shown)\$77.99
- 149992 flat coarse, blue\$89.99
- 149993 flat medium, red\$89.99
- 149994 flat fine, green\$77.99

King Arthur Universal Mounting Nut. Specially designed for mounting tandem combinations of Lancelots, Lancelots/Squires and Holey Galahad. Fits all 5/8" x 11 TPI arbors.

- 149995\$10.99

LANCELOT Wood Carving Discs (A)

The special chainsaw blade is securely held between two stainless steel plates. Mount the 4" dia. Lancelot in your 4" or 4 1/2" angle grinder and it easily cuts the hardest woods regardless of grain or knots. The 14-tooth model is great for "roughing-out", the 22-tooth model leaves a smoother "finished" surface. Teeth can be resharpened using a standard chainsaw file. Maximum 14,000 RPM, chains can not be interchanged between models.

	Teeth	Arbor	
04D02	14	5/8"	\$52.50
04D04	22	5/8"	\$52.50
04D06	14	7/8"	\$52.50
04D07	22	7/8"	\$52.50
04D03	replacement 14T chain		\$27.50
04D05	replacement 22T chain		\$27.50

SQUIRE Mini Carving Discs (B)

Can be attached to another disc for the ultimate in power carving! Although it can be used alone as a small carving disc, by attaching the 3 3/8" dia. Squire to a Lancelot disc with the Universal Mounting nut (below) you can effectively double your cutting capacity. Remove waste material faster and curved work is easier and smoother than using a single disc. Fits all mini grinders with 5/8" x 11 TPI arbors.

- 127230 Squire with 12-tooth chain \$52.50
- 127231 Squire with 18-tooth chain \$52.50

King Arthur Universal Mounting Nut. Specially designed for mounting tandem combinations of Lancelots, Lancelots/Squires and Holey Galahad. Fits all 5/8" x 11 TPI arbors.

- 149995\$10.99



KING ARTHUR Merlin2® Complete Kit

Merlin2 has been completely redesigned, inside and out, with spiral bevel gears, a new upgraded motor, RoHS compliant electronics, a larger fan, additional vents, one-piece cast safety guard, a textured finish and improved design. Carve, cut, shape and sand with one tool! Now carvers who are working on a smaller scale can enjoy the rapid, yet controlled stock removal that large-scale carvers have enjoyed for years with Lancelot woodcarving discs. The special eight-tooth chain disc, which is mounted between two stainless steel plates, easily cuts the hardest woods, regardless of grain or knots. Only 2" in diameter, the disc reaches into tight areas, which previously had to be carved and smoothed by hand. You can rough-out with the chain disc and then smooth and finish shaping with the tungsten carbide disc and flap disc sanders. Complete kit contains one variable-speed Grinder and one each of the following accessories: coarse Carbide Disc, 60-, 120-, 240-, 320- and 600-grit Flap Discs, fiberglass Cutoff Wheel, and an eight-tooth Standard Saw Chain Disc.

- 159497\$289.99

Merlin 2 Flap Discs

OEM replacement flap discs for the Merlin 2 Mini Angle Grinding Kit.

- 160121 60-grit.....\$7.99
- 160122 120-grit.....\$7.99

120-Piece Diamond Burr Set

Hobbyist and seasoned pro alike will find themselves creating unbelievable detail with these diamond-tip burs and a rotary power carver. Favorites of jewelers and metalworkers, diamond burs are being discovered by woodworkers and woodcarvers. These bits offer fast but controlled cutting action. This 120 pc set offers 30 profiles in four grits, 150, 240, 400, and 600, so you can progress from rapid cutting to final finishing cuts with the same profile!

- 149386\$31.50

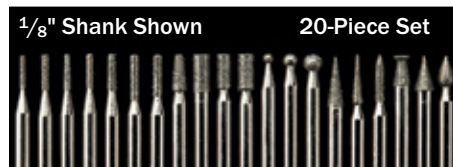

Diamond Carving Burrs

Because diamonds are 1,500 times harder than the hardest metal they last longer than normal burs and may be used to cut or shape a wide variety of materials including wood, metal, stone, or glass. Available in 1/8" or 3/32" shank "jumbo tip" sets. Jumbo profiles are great for larger work or for areas where faster material removal is desired. 28-piece set includes 8-piece jumbo set and similar shank 20-piece set illustrated above.

- 124326 8-pc. 3/32" shank jumbo tip\$19.99
- 18G21 20-pc. 3/32" shank.....\$11.99
- 124328 8-pc. 1/8" shank jumbo tip.....\$19.99
- 18G27 20-pc. 1/8" shank.....\$11.99



FLEXCUT® Power-Carver Blades

Flexcut has developed a new line of quality blades for reciprocating power carvers in the sizes and profiles you need most. The same low-resistance cutting edge that Flexcut is known for now allows your Ryobi, Proxxon, Automach or Wecheer carver to work less and carve more. Automach machines require brass adapters, available separately.

- 128300 1" No. 3 gouge.....\$15.99
- 128301 7/8" No. 5 gouge.....\$15.99
- 129743 3/8" No. 8 gouge *\$13.99
- 128305 1/2" No. 8 gouge\$15.99
- 129740 1/8" No. 11 gouge *\$13.50
- 129744 1/4" x 70° V-parting *\$14.99
- 129745 3/8" x 70° V-parting\$13.99
- 140386 1/2" No. 28 spoon gouge.....\$15.50
- 128302 1" chisel\$16.99
- 145851 automach adapters (20)\$5.50
- 145549 19-pocket blade tool roll.....\$18.99
- 815644 quick-connect palm handle\$15.99

Detail Gouge Set (*) contains an 1/8" No. 11, 1/4" 70° V-parting tool, 3/8" No. 3, 3/8" No. 8 gouge. **128297 set of 4 Save!**\$39.50

Roughing Gouge Set contains a 3/8" 70° V-parting tool, 3/8" No. 8, 5/8" No. 3, and a 5/8" No. 5 gouge.

128298 set of 4 Save!\$43.50

Deluxe Gouge Set contains 14 of the tools listed above (does not include the 1/2" No. 28 spoon gouge or the 1" chisel).

128299 complete set Save!\$147.99



Complete Woodburning Kits

Decorative Branding Kit

Kit includes nine interchangeable tips that give you unlimited design flexibility. The 30-watt branding tool can be used to decorate wood items, picture frames, leather articles and accessories, furniture, cabinets, and decorative plates. The possibilities are endless.

- 127292\$42.99

Temperature Regulator. Use your single-wattage woodburning pen, soldering iron, stencil pen, or branding iron like a variable-wattage unit (500 watt maximum).

- 140231\$48.99

10-In-1 Tool Kit. This versatile tool includes all of the tips and points needed for woodburning, soldering, leather craft, stencil and Styrofoam cutting. Includes a 30-watt professional iron with 6' cord, 7 woodburning tips, 2 cutting and fusing tips, 1 soldering tip and a tool stand, all packed in a plastic case. Tool color may vary from that shown above.

- 127290\$42.99

www.woodcraft.com



Razertip® SS-D10 Double Pen

120V Power Supply, Only

The Razertip SS-D10 is the workhorse in the Razertip line of power supplies, Dual handpiece capability allows you to have two pens plugged and change between them with just the flick of a switch. It not only saves time and wear on the connectors. The SS-D10 features near instant heat response and is fitted with an extra low-end temperature adjustment allowing you to turn the heat down further if the "1" setting is still too hot. It is CSA C/US safety certified and covered by a three-year unconditional warranty. The SS-D10 is very useful for sculpting wax or detailing plastics. **Note: Requires the purchase of handpiece and cord (both sold separately) to use this power supply.**

160477 \$159.99



Razertip® 10AMP SK Single Pen

120V Power Supply, Only

This little Razertip unit is packed with the same power and circuitry as its big brother (160477), making it a great starter unit or a second burning unit. The SK power supply features a near instant heat response, a three-year unconditional warranty and is CSA C/US safety certified. The SK will accept only one pen at a time, making it necessary to unplug and plug in handpieces when changing pen profiles. **Note: Requires the purchase of handpiece and cord (both sold separately) to use this power supply.**

160476 \$119.99



Razertip® Standard Tip Cord, 39" 18-Gauge RCA(M) to RCA(M)

For use with Razertip Standard and Binding Post Interchangeable Tip (BPH) pens.

160479 male to male connectors..... \$17.99

Razertip® Heavy-Duty Tip Cord, 39" 16-Gauge RCA(M) to RCA(M)

Fits Razertip HD and Binding Post Interchangeable Tip (BPH) Pens when two burning tips are installed and additional wattage is needed.

160480 male to male connectors..... \$18.99

Razertip® Adapter Cords

39" 18-Gauge RCA(M) to 1/4" Phone Jack

Allows Razertip Standard and Binding Post Interchangeable Tip (BPH) Pens to be used on power supplies with a 1/4" phone jack (Detail Master, etc.).

160481 male connector..... \$17.99

39" 16-Gauge RCA(M) to 1/4" Phone Jack

For Razertip HD and Binding Post Interchangeable Tip (BPH) Pens, used on power supplies with a 1/4" phone jack (Detail Master, etc.).

160482 male connector..... \$18.99

12" 16-Gauge RCA(M) to 1/4"(F) Phone Jack

Allows Detail Master Pens to be used on a Razertip power supply.

160483 male to female connectors..... \$16.99

RCA(M) to 1/4" Phone Jack

For Detail Master or similar pens when used with a Razertip power supply.

160484 male connector..... \$6.99



Foam Grip Replacements

160486 (A) Fixed Tip Std. Repl. grip..... \$1.99

160487 (B) Fixed Tip Std. X-thick grip..... \$1.99

160488 (C) Fixed Tip HD Repl. grip..... \$1.99

PEN and TIP Profile Selection

	BPH	HD BPH	Fixed Tip	HD Fixed Tip
	EACH: \$6.59	\$6.99	\$29.99	\$32.99
Large Skew	160489		160490	
Small Skew	160491		160492	
Extra Small Skew			160493	
Large Round Skew	160494		160495	
Small Round Skew	160496		160497	
Small Round Tip	160498		160499	
Medium Spear	160500	160518	160501	160519
Small Spear	160502		160503	
Small Curved Spear	160504		160505	
Small Chisel	160506		160507	
Large Coarse Detail	160508		160509	
Medium Coarse Detail	160510		160511	
Small Coarse Detail	160512		160513	
Medium Multi-use	160514		160515	
Gourd Cutter	160516		160517	
7mm Transfer Shader	160526		160527	
#9 Writing Tip	160528		160529	
.8mm Ball Stylus Tip	160530		160531	
1.5mm Ball Stylus Tip	160532		160533	
HD Medium Spear Shader		160520		160521
HD Medium Spoon Shader		160522		160523
HD Small Spoon Shader		160524		160525
SETS	\$23.99	\$34.99		
Bird Carver's Micro Set, 5-pc.	160534			
Pyrography Set, 5-pc.	160535			
Ball Tip Set, 5-pc.	160536			
Bird Carver's Set, 8-pc.		160537		
Gourd Artist's Set, 5-pc.	160538			

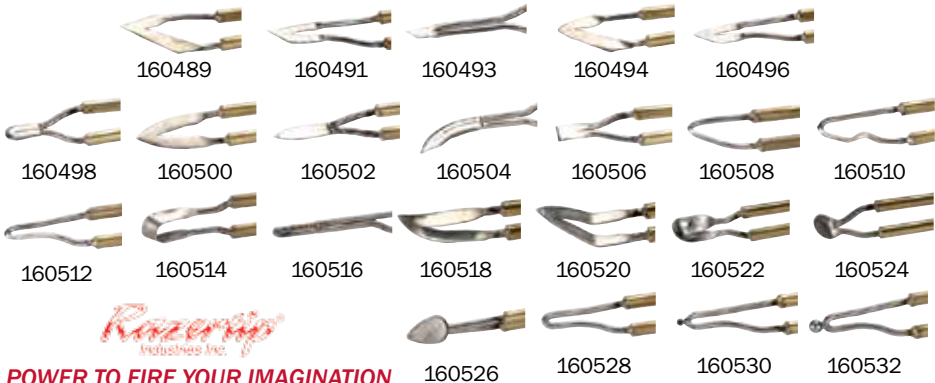

POWER TO FIRE YOUR IMAGINATION



BPH/BPH HD



HD Fixed Tip

Razertip® (BPH) Binding Post Interchangeable Tip Pen

The best interchangeable-tip pen in the world! The BPH accepts all of Razertip interchangeable tips. The BPH also lets you install two tips at once for perfect parallel lines or faster feather and hair texturing (may require higher heat settings and a heavy-duty cord). The BPH is cooler on your fingers than any other interchangeable-tip handpiece, and it's built to last a lifetime. Pen supplied with one each of 3" lengths of Heavy-Duty, Standard, and Light-Duty Tip Wire so you can make custom tips.

160478 \$29.99

see chart for Interchangeable Tip profiles -

BPH Tips \$5.50

BPH HD Tips..... \$5.99

Razertip® Tip Cleaner/Scraper

This ingenious tool removes carbon buildup from most tips quickly and easily. Prolongs tip life. Works without turning off power. New design includes a flip-away blade cover for safety

160485 \$11.99



Razertip® HD Fixed Tip Pens

The Razertip HD Fixed Tip Pens are an excellent general use pen for pyrography, cutting, and fine detail/small work. Pen features include: construction from the most advanced temperature resistant resins today; front, mid-body and rear ventilation slots allow hot air to easily escape; a laser welded tip to ensure a stronger bond and longer life; a corrugated front body that allows for a greater surface area for better cooling under the comfortable foam grip that provides superb control. Pen is slightly larger than a #2 pencil.

see chart for HD Fixed Tip profiles.. each \$31.99



160492

Fixed Tip

Razertip® Standard Fixed Tip Pens

This Razertip Standard Fixed Tip Pens are an excellent general use pen for pyrography, cutting, and fine detail work and includes all construction and use features of the HD pen, above.

see chart for Fixed Tip profiles.....each \$27.99

Files & Rasps



Cabinetmaker's Files & Rasps

(A) Cabinet Rasps. Used by cabinetmakers for fast, accurate wood removal. Curved on one side, flat on the other, single cut on the edges. The shorter the rasp, the smaller the rasp teeth, the finer the cut. 2nd cut. Handle (G) sold separately.

Length	Size	Handle	
06B31	8"	29/32" x 1/4"	S.....\$34.50
06B32	10"	1 1/8" x 9/32"	M.....\$37.25

(B) Nicholson Cabinetmaker's Rasps cut evenly and smoothly. Edges are cut to allow filing narrow grooves. All are curved on one side, flat on the other. "2nd cut" is slightly coarser and faster cutting than "smooth". 10" x 7/8". These are the smoothest cutting rasps you'll ever use. Handle (G) sold separately.

Cut	Handle	
06B01	2nd cut (#49)	M.....\$51.99
06B02	smooth cut (#50)	M.....\$68.50

(C) Wood File. Half-round wood files are made like metal files, but have coarser teeth for use on wood. While a rasp cuts the wood with individual small

teeth, this file smoothes it with a shearing action. Handle (G) sold separately.

Length	Size	Handle	
06B06	10"	1" x 9/32"	M.....\$28.99

(D) Round Rasp. A bastard cut rasp for quick removal of stock from circular openings and for forming concave surfaces. Handle (G) sold separately.

Length	Size	Handle	
06B03	10"	3/8" dia.	S.....\$37.50

(E) Round File. For smoothing after preliminary shaping with a round rasp. Handle (G) sold separately.

Length	Size	Handle	
06B04	10"	3/8" dia.	S.....\$21.99

(F) Screw-On File Handles are easier on the hand than plain file tangs and give you added control. Finished hardwood handles with heavy steel ferrules, 4 1/2" to 5" long. S = small, M = medium.

Size	Thread Size	File Length	
06B54	S.....	5/16"-24	8".....\$4.50
06B55	M.....	3/8"-24	10".....\$4.50

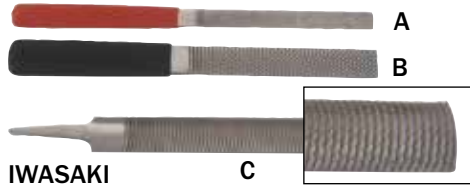

IWASAKI Japanese Carving Files

Iwasaki files cut with surprising speed and yet leave a smooth surface the result of a file that will cut like a plane, but with very little resistance and with the built-in chip-breakers to help prevent clogging. All of the files are safe edged, for use to adjust mortise and tenon joints like a float or to fine tune the body of a wood plane. Suitable for all types woods or plastics. With the choice of a medium, fine and

extra fine tooth configuration Iwasaki Carving Files offer the right file for your task at hand.

150554	(B) 150mm flat medium cut\$22.50
150555	150mm half-rnd. medium cut\$21.50
150556	200mm flat medium cut\$29.99
150557	(C) 200mm half-rnd med. cut\$32.99
150558	150mm flat fine cut\$35.99
150559	150mm half-round fine cut\$37.99
150560	150mm flat extreme-fine cut\$36.99
150561	150mm half-rnd ext.-fine cut\$33.99
150562	200mm flat fine cut\$40.99
150563	200mm half-round fine cut\$36.99
150564	200mm flat extreme-fine cut\$42.99
150565	200mm half-rnd ext.-fine cut\$38.99
150566	(A) 110mm flat extreme-fine cut\$31.50
150567	110mm half-rnd ext.-fine cut\$32.99

Iwasaki's Woodworking Files

offer exceptionally sharp teeth, which are manufactured using a new chemical polishing process. The new tooth design keeps the files clean, minimizing clogging. They are suitable for use on all types of wood, bamboo, plastic, resin, gypsum etc. Japanese craftsmen are enthusiastic users of these rasps for woodcarving, cabinetmaking, musical instrument construction and model making among other crafts. Use light strokes for fast, easy removal of material. Set includes: Extra Fine (3mm, 5mm, 6mm, 8mm), Fine (5mm, 6mm, 8mm), 2nd Cut (8mm)

159194	(A) 8-Piece Round File Set with Pouch\$189.99
159195	(B) 8" Extra Fine Side Float\$56.99
159196	(C) 8" Extra Fine Edge Float\$50.50
159197	(D) Curved Half-round Fine File\$27.99
159198	(E) Crank Neck Flat Bastard File With Handle\$20.50
159199	(F) Crank Neck Half-round Bastard File w/Handle\$19.99
159200	(G) 8" Half-round Extra Fine File\$55.99
159201	(H) 3.5", 3mm Dia. Round File, EF Cut, with Handle\$18.99
159202	(I) 4", 6mm Dia. Round File, EF Cut, with Handle\$25.99

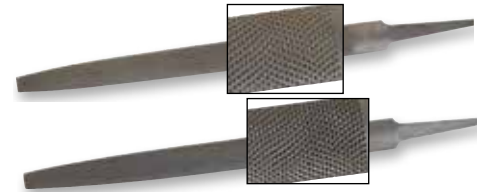
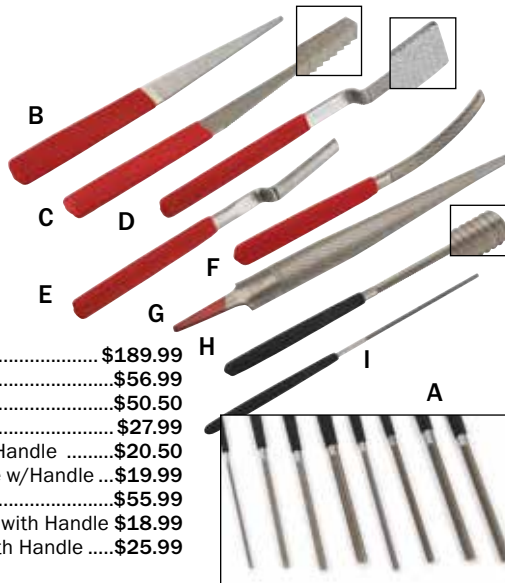

Grobet Half-Round 10" Rasps

Grobet Rasps are made in Switzerland, and we feel they are the best machine-made rasps being produced today. They are tough, sharp, cut quickly and are capable of producing a smooth finish, as well as removing material in a hurry. Grobet Rasps are available in two cuts or finishes. The cut 5 rasp is a visibly coarser, much more aggressive cut than the cut 6, while the cut 6 has many more teeth and produces a much smoother surface. Edges on both are cut to allow the filing of narrow grooves. No rasp should be used without a handle, so we recommend purchasing a screw-on handle, if you don't already have one.

159097	cut 5\$82.99
159098	cut 6\$94.99
06B55	handle 3/8"-24\$4.50



Needle Rasp Set

These small, quick-cutting rasps are highly valued for adding fine detail and intricate shaping. 6 1/4" long rasps comes in six different styles and includes a 3 3/4" wooden handle.

100101	set of 6\$46.99
02T11	extra handle\$7.99



Precision Needle Files

Made of high-quality chrome-alloy steel with deep, carefully milled gullets for rapid and clean cutting (No. 2 cut). Leaves a smooth finish on wood, metal and plastic. Twelve-piece set, 140mm (5 1/2") length.

16H10	set of 12\$35.99
-------	-----------	--------------

8-Piece Riffler Rasp Set

The coarse-cut teeth of these double-ended rifflers will eat through the toughest woods in no time, and the selection of 8 different shapes provides you with the right tool for every shaping job. Handmade in China by a small, specialized firm, these rasps are worked from quality steel to give you a set that will keenly perform for years and years. Rasps are 8" long with faces 1/2" to 5/8" wide. A tremendous value.

140045	\$26.50
--------	--	--------------

Files & Rasps



Shinto Saw Rasps

Shinto Saw Rasps are flat rasps made from 10 saw blades, with hardened teeth that are "ganged" together with rivets to form the rasp. The teeth are oriented for cutting on the push stroke, with coarse teeth on one side and fine on the other just like a normal rasp. The teeth are designed to help prevent clogging, but also are easily cleaned if necessary. While the Shinto may appear odd when compared to traditional rasps, once you try one, we think it will become one of your most used tools. Nominal blade lengths are shown below. Rasp blade width is approximately 1³/₁₆". Add 4¹/₂" to the blade length for overall rasp length.

- 151297 (A) 9" rasp..... \$34.99
- 153777 (A) 11" rasp..... \$37.99
- 153778 (B) 10" planer rasp \$40.75
- 153779 10" planer rasp repl. blade..... \$23.50



Specialty Rasps

4-in-1 Hand Rasp combines a fine and medium wood rasp and file in one tool! 8" long, curved on one side, flat on the other.

145481 (A)..... \$12.99

Sculptor's Rasp. A versatile file-rasp combination; one end fine for finishing, the other coarse for shaping. Four working sides, 2 half-rounds, 2 flat. 9" long with 3" working surfaces.

06A04 (B)..... \$49.99

Keyway Rasp is two tools in one! Half is a 5¹/₁₆" round rasp, the other a 1/2" flat rasp. Very useful for shaping holes or surfaces in doors, furniture, sculpture, and much more. Length 8³/₄", coarse #2 cut.

17J61 (C)..... \$25.99



GRACE USA Hook And Pick Set, 6-piece

Grace USA's 6-Piece Hook and Pick Set is precision manufactured and hand assembled entirely within the United States and designed specifically to serve the needs of both professional and hobbyist gunsmiths. Each tool is constructed of US 8650 chromium-vanadium steel alloy and given a durable black oxide finish. Handles are composed of turned Maine hardwood, topped off with a nickel-plated steel ferrule. Set includes: 1/8" Scribe, 30° Bent Pick, 90° Bent Pick, Double Bend Pick, 180° Loop Pick, and 180° Hook Pick, all packaged in a plastic storage sleeve. The quality of materials and workmanship ensures that these tools will provide years of reliable service.

158880 \$19.99

Our Finest Italian Hand-Cut Rifflers

For sculptors and woodcarvers, these 7¹/₂" rifflers are indispensable. Manufactured of the finest materials under the strictest quality control standards, these sets are a favorite of carvers worldwide. There are eight different shapes to a set, both ends have the same shape, and cut. We offer either hand-cut rasp or file cuts. Rasps are toothed around whole end, files have one smooth side each end.

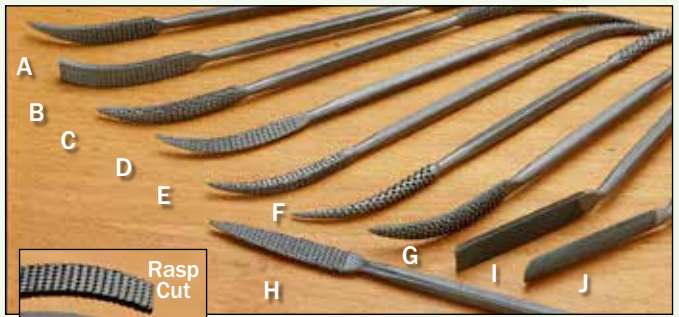

- 17J40 files set of 8 (A-H) **Save!** \$196.99
- 17J55 rasps set of 8 **Save!**..... \$194.99
- 17J30 set of 16 **Save!**..... \$319.99

Also available individually.

Style	File Cut		Rasp Cut	
	ea.	\$26.99	ea.	\$26.99
(A) flat taper	17J41	17J51	(F) round	17J46
(B) flat	17J42	17J52	(G) half round	17J48
(C) oval	17J43	17J53	(H) knife	17J47
(D) triangle	17J44	17J54	(I) flat straight	17J49
(E) square	17J45	17J56	(J) half rnd str.	17J50



Sanding Stick Kits

Newly designed pencil-type sticks are hexagon shaped for comfort, feature thumb and finger supports, and hold 1/4" x 12³/₄" aluminum oxide belts. The 6¹/₄" x 1/4" sticks are made of impact-resistant plastic and have a spring-tensioned back to keep the sanding belts firmly in place or allow quick belt rotating or changing. The tapered end can be used intricate sanding while the flat side and rounded end add to the versatility of the sanding sticks.

24-Pc. Standard Kit includes 4 color-coded sticks and 5 belts each in 80, 120, 180, and 240 grits.

123283 standard kit..... \$31.99

24-Pc. Finishing Kit includes 4 color-coded sticks and 5 belts each in 240, 320, 400, and 500 grits.

123284 finishing kit..... \$31.99

848828 repl. belts 80 grit (5)..... \$5.50

141852 repl. belts 120 grit (5)..... \$5.50

141853 repl. belts 180 grit (5)..... \$5.50

141854 repl. belts 240 grit (5)..... \$5.50

811418 repl. belts 320 grit (5)..... \$5.50

811419 repl. belts 400 grit (5)..... \$5.50

811420 repl. belts 500 grit (5)..... \$5.50

Abrasive Cords

Perfect for woodturning, restoration, and general sanding of any hard-to-reach or delicate work. Aluminum oxide abrasive on cloth core cords are also excellent for deburring and polishing metal. Available on 50-foot metal spools.

02W32 .055" dia., 120 grit \$16.50

02W33 .055" dia., 150 grit \$16.50

02W34 .030" dia., 200 grit \$16.50

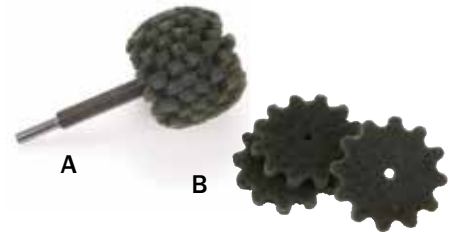

NEW WAVE Scuff & Buff Balls

New Wave Scuff & Buff balls are a great alternative to laborious hand sanding. A patented wavy edge design using non-woven abrasive material ensures consistent finishing quality, and the continuous exposure of new grit means the uniformity of the Scuff Ball does not change. The material allows highly efficient airflow, resists clogging, and leaves the Scuff Ball easy to clean by water or compressed air. All shaft lengths are 3¹/₂", but an optional 5¹/₂" shaft length is sold separately below.

154582 (A) 2" green, 180 grit \$14.99

154583 2" maroon, 320 grit \$15.50

154584 2" grey, 600 grit \$15.50

154585 2" white, polishing..... \$15.50

154586 (B) 2" repl. green scuff, 180 grit \$10.50

154589 2" repl. white scuff..... \$10.50

BRIWAX #0 Steel Wool

Briwax #0 Steel is oil free and comes in a 225gm (weight) continuous roll, making it easy to cut to size with scissors. #0 steel works best for cleaning metal, smooth stone, and porcelain and removing paint and finishes during the stripping process.

158917 #0 \$12.99

844337 #0000 \$12.99



Technical Questions?

Call 1-800-535-4486

For FREE help, and advice!



Sanding & Scraping

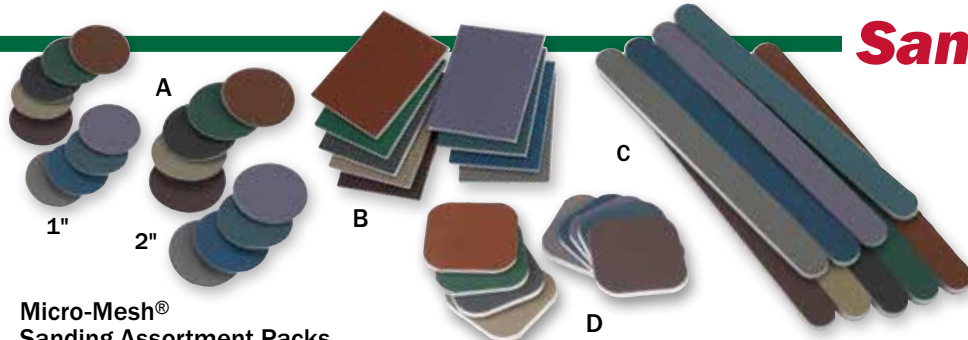

Micro-Mesh®

Sanding Assortment Packs

Micro-Mesh has been used for years to restore airline windows to optical clarity. Only recently have wood turners discovered these incredibly fine abrasives and used them wet or dry to create a polished sheen on bare wood or beautiful luster on finish coatings. Micro Mesh sanding products are ideal for use on bowls, small turnings, or pens. The **Micro-Mesh Hook & Loop Disk Assortment Pack** can be paired with the Sorby Sandmaster (819989) or the Sorby Micro Sandmaster (149670) for the ultimate finish for turnings and is available in three sizes. **Micro-Mesh Soft Touch Pads** are foam backed 3" x 4" two sided pads. **Micro-Mesh Sanding Sticks** are two sided pads that are smaller in size, like a nail file, for those hard to reach areas. **Micro-Mesh Pen Sanding Kits**' 2" x 2" foam backed pads are ideal for giving pen blanks a wet look finish. All kits include one each of 1500, 1800, 2400, 3200, 3600, 4000, 6000, 8000, and 12,000 grits.

- 150861** (A) 1" H&L disk assort. pack **\$5.50**
150862 2" H&L disk assort. pack **\$10.99**
150863 3" H&L disk assort. pack **\$16.50**

- 150859** (B) 3" x 4" soft touch pad pack **\$25.25**
150860 (C) 1/2" x 5" sanding stick pack... **\$12.59**
145982 (D) pen sanding kit **\$14.99**



Micro-Mesh® Sanding Kit

Woodworkers have discovered that these incredibly fine abrasive cloths put a polished sheen on bare wood and a handsome luster on finish coatings. This set is ideal for pen makers. Kit (A) includes one 3" x 4" piece of each of nine abrasive grits from 1,500 to 12,000 and a foam sanding block. Kit (B) includes two 3" x 6" pieces of each of nine abrasive grits from 1,500 to 12,000 and a foam sanding block.

- 142940** (A) small kit **\$23.50**
11L61 (B) large kit **\$62.99**



Micro-Mesh® 5" Disc Assortment Pack

Looking for a perfect finish? Try Micro-Mesh paper on your orbital sander - you'll be amazed at the results! Used for years to restore airline windows to optical clarity, woodworkers have found these ultra fine grit abrasives work equally well on wood finishes. This hook and loop assortment pack contains one each of 1500, 1800, 2400, 3200, 3500, 4000, 6000, 8000, and 12000 grit discs.

- 145983** **\$20.99**



Extra-Long Drum Sanding Set

Turns your drill or drill press into a mini spindle sander. Use it to clean up bandsaw marks on contour cuts, smooth rough edges, or sand the inside surfaces of deep drilled holes on toys or other projects. 12-piece set contains four 1/4" shank drums, 1/2" x 2", 3/4" x 2", 1" x 2", and 1 1/2" x 2". One coarse (50 grit) and one fine (120 grit) sleeve is included for each drum.

- 07P41** 12-piece kit **\$18.99**
128456 sanding drum, 1/2" x 2" **\$4.25**
128457 sanding drum, 3/4" x 2" **\$5.69**
128458 sanding drum, 1" x 2" **\$6.19**
128459 sanding drum, 1 1/2" x 2" **\$6.99**

Sleeveless Sanding Drums

Drum design eliminates the need to buy replacement sanding sleeves. Simply cut and fit any type of sheet sandpaper to the drum. Drums have balanced solid cores with sponge rubber backing to ensure long wear of sandpaper. Unique pinlocking device is simple and effective. Drums can be used in a drill chuck, drill presses, lathes, and portable drills.

- Di. x Length x Shaft dia.
06P13 3/4" x 2 1/4" x 1/4" **\$18.99**
06P21 1" x 3" x 1/4" **\$24.25**
06P31 2" x 3" x 1/2" **\$29.39**
06P14 2 1/2" x 4 1/2" x 1/2" **\$28.50**
06P51 3" x 3" x 1/2" **\$28.99**

Replacement Sleeves. Cloth-backed aluminum oxide. Package contains 12 sleeves.

Coarse (50 grit)	Medium (80 grit)	Fine (120 grit)	Di. x Lgth.	
09V12	07W43	07041	1/2" x 2"	\$9.99
09W23	07W53	07042	3/4" x 2"	\$10.69
09V34	NLA	07051	1" x 2"	\$10.99
NLA	08I62	07052	1 1/2" x 2"	\$13.50

Assorted Sanding Spindles, 6-pack

Aluminum Oxide Industrial Abrasives spindle sleeves will fit most standard spindles, including RYOBI, JET, DELTA, GRIZZLY, ENLON, plus other popular models.

- 6" in 1/4", 1/2", 5/8", 1 1/2", 2", 3" diameters
 60 grit 80 grit 100 grit 120 grit
149905 149906 149907 149908 \$16.75
 4 1/2" in 1/4", 1/2", 3/4", 1 1/2", 2", 3" diameters
 50 grit 80 grit 100 grit 120 grit
149377 149376 - 149375 \$11.75

Brand names are registered Trademarks of their respective companies.

Make Your Own Sanding Sleeves!



ARBORTECH

Mini TURBO™ Kit

The Arbortech Mini TURBO™ Kit is a revolutionary tool for woodworking that can be used either directly on the Arbortech Mini Grinder™ or fitted to any standard 4" or 4 1/2" angle grinder by using the supplied extension. It is the perfect kit for medium size sculpting projects, from start to finish as the carbide cutters can easily be loosened with the provided tool and rotated to a new edge. Kit includes four mini sanding pads: 40-grit, 60-grit, 80-grit, and 120-grit.

- 160733** Mini TURBO™ Kit **\$159.99**
160734 repl. teeth & screw 2-pc. **\$44.99**
160735 mini sander, 40-grit 4pk. **\$17.99**
160736 mini sander, 60-grit 4pk. **\$17.99**
160737 mini sander, 80-grit 4pk. **\$17.99**
160738 mini sander, 120-grit 4pk. **\$17.99**



ARBORTECH

Contour Random Sander

The Arbortech Contour Random Sander is a patented angle grinder attachment designed to fit on a standard angle grinder providing a powerful random-orbital action. Designed to work in hard-to-reach internal profiles, the sander features a 2 1/2" shaft that puts the unique sanding head into deep hollow areas. The patented flexible sanding pad molds to the surface shape. Includes one Contour Random Sander; five each of 50mm PSA Sanding Discs: 80-grit, 120-grit, 180-grit, 240-grit, 320-grit, 400-grit, and 600-grit.

- 160726** contour random sander **\$104.99**
160727 replacement pad **\$17.99**
160728 50mm 80-grit disc, 25-pk. **\$10.99**
160729 50mm 120-grit disc, 25-pk. **\$10.99**
160730 50mm 180-grit disc, 25-pk. **\$10.99**
160731 50mm 240-grit disc, 25-pk. **\$10.99**
160732 50mm 320-grit disc, 25-pk. **\$10.99**



PORTER CABLE

Stikit™ Sandpaper System

Simply cut Stikit and the adhesive-backed paper sticks to your sanding pad. Available in 4 1/2" wide rolls, 10 yds. long.

- 13W42** 80 grit **\$22.99**
13R34 100 grit **\$22.99**
12B32 120 grit **\$22.99**
12H14 150 grit **\$22.99**
13W52 180 grit **\$22.99**
12B42 220 grit **\$22.99**
12E12 320 grit **\$22.99**

Sanding & Scraping

NORTON

SAINT-GOBAIN

9" x 11" 3X Sheets 20-Sheet Job Packs

- Consistent Sanding Performance
- Excellent On All Surfaces And Coatings
- Will Not Clog, Tear Or Transfer Color
- Aluminum Oxide

146362	80 grit	\$21.99
827648	100 grit	\$20.99
827643	120 grit	\$20.99
828419	150 grit	\$20.99
827644	180 grit	\$14.99
827645	220 grit	\$14.99
827646	320 grit	\$14.99
827647	400 grit	\$14.99



9" x 11" SandWet™ Sheets, 5-Packs

For wet, oil, or dry sanding primer, sealer, varnish, lacquer, enamel, and other topcoats.

85W13	220 grit	\$8.99
85W12	320 grit	\$8.99
85W11	400 grit	\$8.99
85W10	600 grit	\$8.99
146334	800 grit	\$8.99
146333	1200 grit	\$8.99
146332	1500 grit	\$8.99
146331	2000 grit	\$8.99



SandWet Sanding Sponges

Create a smooth surface with Norton SandWet Sanding Sponges. Wet/dry paper on two surfaces and a conforming texture make it easy to sand curved or flat surfaces, details and more. Wet-sanding cuts down on dust. Simply rinse and reuse sponge when finished. Ideal for wood, metal, fiberglass and painted surfaces. The 4 3/4" x 2 7/8" x 1" sponges are available in 1000, 1500, and 2000 grits.

162040	2000 grit	\$7.99
162041	1500 grit	\$7.99
162042	1000 grit	\$7.99



3" x 35' Sanding Rolls

These rolls are for general purpose sanding where flexibility and tear-resistance are important. The cloth backing provides the paper with increased strength and durability. Most common uses are: Hand Strapping, Light Deburring, Blending Machine Tool Marks, Cleaning Pipe & Tubing.

146386	80 grit	\$26.99
146387	120 grit	\$26.99
146388	220 grit	\$26.99

ProSand™ MULTI-AIR Sanding Discs

- Premium Ceramic Alumina Abrasive With Precision Laser-Cut, Spiral-Hole Pattern For Maximum Dust Extraction
- Multi-Hole Pattern Fits Any 5" or 6" Hook And Loop Sander
- Unique, Fiber Reinforced Backing – Edge Tear Resistant
- Non-Pigmented, Water-Based Zinc Stearate Coating
- Hook & Loop Backing – Allows Easy Disc Change And Repeated Use

	3 pack, 5"	10 pack, 5"	50 pack, 5"	10 pack, 6"
60 grit	\$5.99	\$15.99	\$39.99	\$17.99
80 grit	146314	829381	146322	162171
100 grit	146313	829382	829705	162170
120 grit	146312	829383	829706	-
150 grit	146311	829384	146319	162169
180 grit	146310	829385	829707	-
220 grit	146309	829386	829708	162168
320 grit	146308	829387	829709	-



Soft Touch Sanding Sponges

- 4 1/2" x 5 1/2"
- Flexible Foam Contours To Surface Shape
- Washable For Extended Use

	Single	20-Piece Box
120/180 grit	\$2.49	\$39.99
320/400 grit	158685A	158685
500/600 grit	158686A	158686
800/1000 grit	152852	152853
1200/1500 grit	152854	152855
	152856	152857



5X Premium Sanding Sponges

- High-Performance, Open-Coat Aluminum Oxide Grain
- Lasts Up To 5X Longer Than Sandpaper With Resistance To Tearing
- Makes Sanding Of Various Surfaces And Hard-To-Reach Areas Easier
- Washable – Extends Life; Rinse And Reuse

	Contour, 2-Pack:	Single Angle:	Small Area:
	4 1/2" x 5 1/2" x 3/16"	4 1/2" x 3 1/2" x 1"	4 1/2" x 2 11/16" x 1"
	\$4.99 ea.	\$4.99 ea.	\$4.99 ea.
	3+ \$4.49	3+ \$4.49	3+ \$4.49
60 grit	158652	-	158659
80 grit	-	158655	-
100 grit	158651	-	-
120 grit	-	158654	158658
180 grit	158650	-	158657
220 grit	158649	-	158656



6" x 9" Non-Woven Abrasive Pads

- Ideal Replacements For Steel Wool
- Washable And Reusable
- Can Be Cut And Folded
- Won't Rust, Shred, Or Splinter

	Single	5+
146745A	green #0 (20)	\$1.49 \$1.29
146746A	maroon #00 (20)	\$1.49 \$1.29
146747A	gray #000 (20)	\$1.49 \$1.29
146748A	white #0000 (10)	\$1.49 \$1.29
146750	hand pad holder	\$11.99

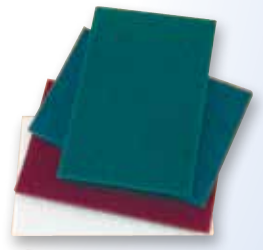

REDHEAT

REDHEAT® Sanding Belts

- Ceramic Abrasive Creates The Fastest Cutting And Longest Lasting Belts
- Consistent Scratch Pattern For Better Surface Finish
- Sand All Types Of Wood And Metal
- Highly Durable With Resistance To Tear, Heat And Loading For Optimal Productivity

	6" x 48"	6" x 48"	4" x 36"
36 grit	\$31.99	\$42.99	\$19.99
50 grit	-	158664	-
80 grit	158663	-	158667
120 grit	158661	-	158666
	158662	-	158665
4" x 24"	\$9.99	3" x 21"	\$5.99
50 grit	158671	158677	
80 grit	158670	158676	
120 grit	158669	158675	



Sanding Belts

- Aluminum Oxide Belts
- For Heavy Stock Removal, Finish Sanding and Polishing

6" x 48" Belts, 1 per pack

146347	50 grit.....	\$13.99
146348	80 grit.....	\$13.99
146349	100 grit.....	\$13.99
146350	120 grit.....	\$13.99
146351	180 grit.....	\$13.99
146352	220 grit.....	\$13.99

4" x 36" Belts, 1 per pack

146378	80 grit.....	\$7.99
146379	120 grit.....	\$7.99
146380	220 grit.....	\$7.99

4" x 24" Belts, 5 per pack

146364	80 grit.....	\$18.99
146365	120 grit.....	\$18.99
146366	180 grit.....	\$18.99

3" x 24" Belts, 5 per pack

146370	80 grit.....	\$11.99
146368	120 grit.....	\$11.99

3" x 21" Belts, 5 per pack

146374	80 grit.....	\$11.99
146373	120 grit.....	\$11.99
146372	220 grit.....	\$11.99

3" x 18" Belts, 2 per pack

158684	80 grit.....	\$6.99
158683	120 grit.....	\$6.99

2½" x 14" Belts, 2 per pack

158682	80 grit.....	\$9.99
158681	120 grit.....	\$9.99

1" x 42" Belts, 1 per pack

146338	100 grit.....	\$2.99
153222	220 grit.....	\$2.99

1" x 30" Belts, 3-pack assortment

151251	fine/med/coarse.....	\$11.50
--------	----------------------	---------



MIRKA



ABRANET® Sanding Discs And Pads

Abranet® is a revolutionary new sanding material that contains thousands of small holes, making it possible to effectively vacuum away dust and other particles without clogging the disc surface. The result is seen in a very uniform sanding pattern and perfectly smooth surface.

5" Discs (10)		6" Discs (10)	
147491...	\$21.50	80 grit	147501...\$22.75
147492...	\$18.99	100 grit	147502...\$22.75
147493...	\$18.99	120 grit	147503...\$22.75
147494...	\$18.99	150 grit	147504...\$22.75
147495...	\$18.99	180 grit	147505...\$22.75
147496...	\$18.99	220 grit	147506...\$22.75
147497...	\$18.99	320 grit	147507...\$22.75
147498...	\$18.99	400 grit	147508...\$22.75
147499...	\$18.99	600 grit	147509...\$22.75

Assortment Packs include one of each grit and one pad protector.

147500	5" assortment.....	\$23.50
147510	6" assortment.....	\$29.99

(A) **Backing Pads** are designed for max dust extraction on RO sanders using Abranet discs.

147512	5" Porter Cable.....	\$41.50
--------	----------------------	---------

(B) **Pad Protectors** protect the sander's backing pad from wear/tear when sanding aggressively and continuously with Abranet. Place between the backing pad and the sanding disc. Change regularly.

147518	5" pad protector (2).....	\$18.99
147519	6" pad protector (2).....	\$18.99

(C) **Interface Pads** are used with hook & loop sanding discs for sanding rounded surfaces and contours. Place between the base plate and sanding disc.

147516	5" interface pad.....	\$16.99
147517	6" interface pad.....	\$16.99

Abranet® HD

Each assortment includes 10 each of 40-, 60-, and 80-grit discs - 30 pieces total.

153163	6" assortment.....	\$44.50
--------	--------------------	---------

Abranet® Disc Assortment

Each 5" and 6" assortment includes 5 each of 80-, 120-, 180-, 240-, 320-, 400-, and 600-grit discs, 35 pieces total.

840644	5" assortment.....	\$36.50
840645	6" assortment.....	\$40.99

Abralon® 6" Discs

These patented, flexible discs create a smooth sanding pattern on angled and profiled surfaces while minimizing pressure marks. The flexible weave also makes it suitable for both dry and wet sanding, by machine or hand.

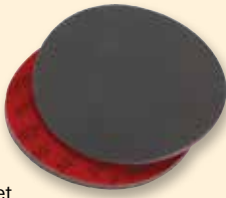

153541	360 grit, 2-pack.....	\$13.50
153542	500 grit, 2-pack.....	\$13.50
153543	1000 grit, 2-pack.....	\$13.50
153544	2000 grit, 2-pack.....	\$13.50
153545	4000 grit, 2-pack.....	\$13.50

ABRANET® Sanding Sheets

2½" x 8" Sheets Assortment contains one each of grits 80, 100, 120, 150, 180, 220, 320, 400 and 600

849873	Assortment (30).....	\$39.99
150317	Assortment (9).....	\$18.50
150326	600 grit box (10).....	\$20.99
150325	400 grit box (10).....	\$20.99
150324	320 grit box (10).....	\$20.99
150323	220 grit box (10).....	\$20.99
150322	180 grit box (10).....	\$20.99



Technical Questions?

Call 1-800-535-4486
For FREE help, and advice!



NEW WAVE Hook & Loop Sanding Discs

The new wavy-edge design of these discs overhangs the holder and arches around the edge to help prevent "dig-ins" caused by the edge of the disc contacting the surface of the wood. Made of Hi-Per Gold sandpaper which uses special lubricants on the surface of the discs to reduce loading and resin clogging, and incorporates an extremely flexible backing which smoothly conforms to curves.

New Wave Bowl Sanding Kit contains one hook & loop style sanding pad (¼" shank), one hard and one soft interface pad, and 5 each 60, 120, 220, and 320 grit sanding pads.

142960	2" bowl sanding kit.....	\$47.99
142961	3" bowl sanding kit.....	\$61.50

Replacement & Interface Backing Pads are used with any standard hook & loop style foam holder and New Wave sanding discs. Available in soft for finer sanding and better conformation to curves, hard for heavy sanding or sanding sharp definitions.

149225	2" very soft pad.....	\$5.50
141390	2" soft pad.....	\$5.50
141391	2" medium pad.....	\$5.50
141393	3" soft pad.....	\$8.99
149224	3" very soft pad.....	\$8.99
141392	3" medium pad.....	\$8.99
152801	2" repl. pad with ¼" shank.....	\$15.99
152802	3" repl. pad with ¼" shank.....	\$17.99

SORBY Hook & Loop Style Sanding Pads. Use with the Interface Backing Pads and New Wave Sanding Discs.

17K70	2" foam sanding pad.....	\$32.99
17K71	3" foam sanding pad.....	\$42.99



NEW WAVE Gold Sanding Discs in bags of 10.

2" Discs	Grit	3" Discs		
158170.....	\$7.25	60 grit	158181.....	\$8.29
158171.....	\$5.99	80 grit	158182.....	\$7.25
158172.....	\$5.99	100 grit	158183.....	\$7.25
158173.....	\$5.99	120 grit	158184.....	\$7.25
158174.....	\$5.99	150 grit	158185.....	\$7.25
158175.....	\$5.99	180 grit	158186.....	\$7.25
158176.....	\$5.99	220 grit	158187.....	\$7.25
158177.....	\$5.99	320 grit	158188.....	\$7.25
158178.....	\$5.99	400 grit	158189.....	\$7.25
158179.....	\$5.99	600 grit	158190.....	\$7.25

NEW WAVE Featuring Abranet® by Mirka (10pk)

2" Discs	Grit	3" Discs		
158158....	\$13.50	80 grit	158164.....	\$15.50
158159....	\$13.50	120 grit	158165.....	\$15.50
158160....	\$13.50	180 grit	158166.....	\$15.50
158161....	\$13.50	240 grit	158167.....	\$15.50
158162....	\$13.50	320 grit	158168.....	\$15.50
158163....	\$13.50	400 grit	158169.....	\$15.50

Sanding & Scraping



GUINEVERE Sanding System

Create a smooth and velvety finish on wood as well as metals, plastic, bone and horn with the Guinevere Sanding System. This system of inflatable sanders adapts to the shape of your work, from concave to convex, angled or flat. The cloth sanding sleeves are long-lasting and easy to switch out.

Guinevere Sanding Kit is ideal for difficult profiles. Its dome sander is designed for round, curved, bulging or cup-formed shapes while the drum sander is used on flat or convex surfaces. Kit includes (1) inflatable dome sander (2³/₈" x 1⁹/₁₆"), (4) dome sanding sleeves (coarse to extra-fine grit), (1) inflatable drum sander (2¹/₂" x 1³/₄"), (4) drum sanding sleeves (coarse to extra-fine grit), double-acting micro hand pump, and sandpaper cleaning stick. Sanders have a 1/4" shank and fit the Guinevere motor, flex shafts, and drills. Drums and sleeves are also available individually.

Guinevere Flexible Shaft with Chuck. With a maximum reach of 51", this vibration-free flexible shaft, connected to the easily movable Sanding and Polishing Motor or other rotary power source, will allow you tremendous flexibility and maneuverability in most work positions.



Intended for low-speed use (3,000 to 10,000RPM), this quality Swedish flex shaft has 2 encapsulated ball bearings in the handpiece and one in the drive end for continuous work and is extremely flexible due to the double spiral steel cord in the protective tube.

Guinevere Sanding and Polishing Motor.

This small and portable, extremely quiet but powerful motor is the perfect power source to use with the Guinevere flexible shaft and inflatable sanders. Fitted with two 3/8" chucks, this motor allows you to mount the flex shaft with a sander to one end with the other sander fitted to the remaining chuck. UL listed. Specifications: 115 Volt, 60 HZ, 1/2 HP (300 Watt), 3.0 Amp, 3,600 RPM, 6" height, 12" length, 9.5 lbs.



Guinevere Hand Pump allows you to feel the softness of the bulb while you are pumping, giving you the ideal drum softness for the grit being used. The best pressure is as soft as possible while still keeping the sleeve from moving on the drum.

- 147549 (A) sanding kit \$129.99
- 147550 (B) flexible shaft with chuck \$79.99
- 147548 (C) sanding /polishing motor \$149.99
- 147547 hand pump.....\$12.59
- 147535 inflatable dome sander..... \$43.99
- 147537 dome sleeves, 60 grit (3).....\$12.59
- 147538 dome sleeves, 120 grit (3).....\$12.59
- 147539 dome sleeves, 220 grit (3).....\$12.59
- 147540 dome sleeves, 320 grit (3).....\$12.59
- 147536 dome asst. pack (1 each grit)...\$14.69
- 147541 inflatable drum sander \$44.99
- 147543 drum sleeves, 80 grit (4).....\$11.59
- 147544 drum sleeves, 150 grit (4) \$11.59
- 147545 drum sleeves, 220 grit (4) \$11.59
- 147546 drum sleeves, 320 grit (4) \$11.59
- 147542 drum asst. pack (1 each grit) ...\$12.59

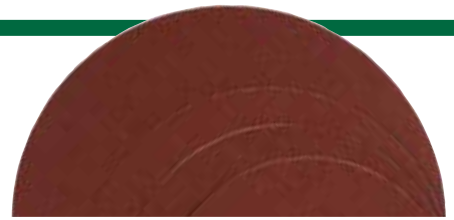

Large Diameter PSA Sanding Discs

You have a benchtop disc sander; we have your abrasive. It starts with an "X" weighted cloth disc; then a bonded aluminum oxide abrasive is added, backed with a durable pressure sensitive adhesive. This adhesive is then covered with a protective peel off liner. Each disc excels in all of the following applications: grinding, sanding, finishing and sharpening, on a multitude of surfaces, and is great for sanding operations requiring flexibility, tear resistance and durability. 3 sanding discs per pack.

- 60 grit 8" \$9.50 153935.....\$10.50
- 80 grit 8" \$9.50 153936.....\$10.50
- 120 grit 8" \$8.50 153937.....\$10.50
- 153932 \$8.50 153938.....\$10.50
- 153933 \$8.50 153939.....\$10.50
- 240 grit 8" \$8.50 153940.....\$10.50
- 60 grit 10" \$11.50 153945.....\$16.99
- 80 grit 10" \$11.99 153946.....\$16.99
- 153941 \$11.99 153947 \$15.99
- 120 grit 10" \$10.50 153948 \$15.99
- 153942 \$10.50 153949 \$15.99
- 180 grit 10" \$10.50 153944 \$10.50
- 240 grit 10" \$10.50 153945 \$16.99



GUINEVERE Inflatable Small Round Sander And Sleeves

The air valve design leaves the bottom flat without a clumsy protruding valve creating a perfectly rounded, rubber molded sander that flexes making the sanders soft all the way to the edge. At only 3/4" diameter, tight spaces are easy to access with the perfect fitting sanding sleeves. Assorted pack contains one each 80, 150 and 320 grits.

- 154103 (A) small round sander\$39.99
- 154104 (B) assorted round sleeves (3).... \$12.99
- 154105 80-grit sleeves (3).....\$12.99
- 154106 150-grit sleeves (3).....\$12.99
- 154107 320-grit sleeves (3).....\$12.99



Abrasive Belt Cleaner

Increases belt and disc life 2 to 4 times. Hold the stick firmly against a moving abrasive belt or disc until all loaded particles are removed-usually a matter of seconds. Available in two sizes.

- 04W11 1 1/2" x 1 1/2" x 8 1/2" \$12.50
- 04S61 2" x 2" x 12".....\$14.69



Ergonomic Sanding Block For 5" Discs

This Ergonomic Sanding Block and a 5" hook-and-loop disc are all you need for precision hand-sanding that produces fine finishing. The sanding block's unique design works effortlessly with the disc and fits the user's palm and fingers to allow better control and reduce fatigue during a long project. Say goodbye to all those other types of sandpaper - no need to buy or cut sheets to fit. Block is 5" x 3 1/4" x 1 1/2".

- 158293 \$9.99



SORBY Hook & Loop Bowl Sanding System

Heavy-duty foam pads are flexible enough to follow the contours of your turnings and, unlike cheaper kits, are durable so they resist tearing when you use heavy grit paper. Hook and loop backing not only firmly secures the disc to the pad, but also makes grit changes quick and easy. For use with portable electric drills, maximum 1,750 RPM. Complete kit includes a 2" pad, 3" pad, and one each of 60, 120, and 240 grit discs for each size pad.

- 17K88 complete kit Best Value! \$109.99
- 17K70 2" foam sanding pad..... \$32.99
- 17K71 3" foam sanding pad..... \$42.99

Sanding discs in bags of 25, 2" discs.

- 17K72 60 grit..... \$11.59
- 17K73 120 grit \$11.59
- 17K74 180 grit \$11.59
- 17K75 240 grit \$11.59



Sand Devil 3.0

Sand Devil 3.0 is a hot idea for hand-sanding. Made from tough glass filled ABS plastic, the Sand Devil 3.0 uses standard 3" x 21" sanding belts with a tensioning lever to keep the abrasive belt tight and flat. As the belt wears, simply rotate it around for fresh abrasive and then change the belt when spent. In addition to flat sanding, the ends are shaped to sand into tight corners and curved surfaces. Use for wet or dry sanding applications. Includes a 120-grit belt. Replacement belts sold separately.

- 161721 \$19.99



PFEIL

Swiss Made® Burnishers

From the makers of pfeil Swiss made tools. These hardened burnishers are manufactured from the highest grade steel, hardened to exacting specifications and polished to a mirror finish polished to reduce friction when rolling a hook. The flattened edge of triangular version is



preferred for traditional rectangular card scrapers while the oval version allows for the sharpening of radius scrapers. Blade is approximately 3/8" by 6 1/4". Overall length is 10 3/4". Natural oil finished cherry handle.

05B52 (A) oval burnisher .. **\$37.69**

05B53 (B) triangular burnisher **\$37.69**



Burnishers are required tools for cabinet scraper users. After scrapers have been squared with a mill file and fine sharpening stone, these hardened steel bladed tools turn over the thin cutting edge that make scrapers operate so effectively. We offer three basic styles, each operating in the same manner but with different blade shapes.

CROWN Round Scraper Burnisher. Features a polished HSS rod fitted with a comfortable rosewood handle. 7 1/4" blade, 12 3/4" overall.

142576 **\$28.50**



WOODSMITH Scraper Sharpening System

This clever system takes all the guess-work out of sharpening and burnishing cabinet scrapers. The anodized extruded aluminum fixture securely holds a mill file and allows you to quickly and precisely shape the edge of scrapers at either 45° for scraper planes, like the Stanley #80, or 90° for handheld scraper blades. Working the scraper along the fixed burnishing pin gives you an even, clean cutting burr. System includes a Nicholson mill file, a 3" x 6" stainless steel cabinet scraper, and easy-to-follow instructions that walk you through the sharpening process. Fixture mounts to piece of 1 1/2" thick stock and can be clamped in your bench vise to provide a stable working area.

141025 **\$78.50**



WoodRiver® 6" Burnisher

The WoodRiver® Burnisher is just the tool to turn the edge on your favorite scraper. It features a round, 3/8" x 6" rod of polished high-speed steel with a hardness of HRC 56-62 set in a fine bubinga handle.

153980 **\$20.99**



Veritas® Scraper Holder

The Veritas® Scraper Holder will accept any thickness of scraper up to 6" in length and is made from glass filled nylon with solid brass fittings. Molded to fit your hand for comfort, simply slide the scraper into the holder, clamp and set the bow with the screw actuated center pad and begin scraping. Each holder comes with a milled edge, super hard scraper.

153367 **\$40.99**



Veritas® Variable Burnisher

Scrapers are incredibly useful tools but require a hooked edge to work properly. The ability to create this edge, at the optimum angle, takes practice and sometimes years of experience. Thanks to the Veritas® Variable Burnisher, you can now create perfect hooked edges from 0° to 15° at will. Simply turn the knob to set and rotate the hub to the desired angle for a perfect hooked edge. The body is made from injected molded, high impact plastic with brass fittings and uses a polished carbide rod to burnish. Instructions included.

141636 **\$32.99**

BAHCO Swedish Cabinet Scrapers

The toughness and reliability of this quality steel has been an immediate hit with woodworkers. It shapes to a keen burnished edge, and stays sharp while working the hardest stock. Available in two lengths and thicknesses. Each is 2 1/2" wide. Sharpening instructions included.

	Length	Thick	Each	3+
02Z08	6"	80mm	\$10.99	\$9.89
02Z09	5"	60mm	\$10.99	\$9.89
100102	set of 2		\$19.99	\$17.99

WoodRiver® Deluxe Scraper Set

This scraper features a comfortable 5 3/4" hardwood handle and 1 1/2" forward knob for fine pressure control. Unlike other scrapers, where blades are attached with a screw, the blades of this scraper are securely clamped to the cast-iron head by the machined, front handle bolt. To change blades you simply loosen the front handle, release the blade, install another blade and retighten the handle. Furnished with five blades, one straight, three concave and one convex in a wooden case with blade storage slots so your blades won't get misplaced or damaged. For custom work, the blades can be easily filed or ground to match the profile of those "impossible" to scrape contours.

148723 **\$41.99**

Pencil to show scale, not included



LYNX Mini Scraper Set, 4-Piece

As handy and good as cabinet scrapers are it's only natural to want small ones, but making them is not simply a matter of stamping out shapes. Consideration has to be given to metal, thickness and shape. Lynx has done the homework and come up with the perfect set. At about 2" in length, the widest being about 13/16" wide and about 0.012" thick - these new mini scrapers are more than just cute, they're hardworking tools that are great for small nooks and crannies. Every package contains four scrapers in the following shapes: Mini Gooseneck, Mini Oval, Mini Square and Mini Convex/Concave.

158977 **\$17.99**

LYNX Straight Scraper Set

For heavier stock removal, cleaning up glue lines, and for removing paint, use this set of 3 stiff, high-grade steel scrapers. Each is 0.8 mm thick, slightly thicker than traditional scrapers, sized 6" x 3", 5" x 2 1/2" and 4" x 2". They're ready for a burnishing right out of the package - no need for initial preparation because they come milled to a sharp 90°.

147420 **\$26.50**



LYNX Concave & Convex Scraper Sets

Our scrapers are made of high quality, tempered, .80mm steel and are ready for a burnishing right out of the package.

The **Concave Set (A)** contains 2 scrapers shaped specifically to scrape curved areas such as spindles and chair legs.

Scraper 1: 1/4", 3/8", 1/2", 5/8", 3/4".

Scraper 2: 7/8", 1", 1 1/8", 1 1/4", 1 1/2".

The **Convex Set (B)** also contains 2 scrapers specifically shaped to scrape in recesses.

Scraper 1: 1/4", 3/8", 1/2", 5/8", 3/4".

Scraper 2: 7/8", 1", 1 1/8", 1 1/4", 1 1/2".

150104 (A) concave set..... **\$15.99**

150105 (B) convex set **\$15.50**

LYNX Quadrant Scraper Set

The Lynx Quadrant Scraper Set is the perfect solution for scraping various quarter and half round moldings, while the straight edges enable tight corner scraping. Each set contains two scrapers with four different quadrants. Scraper #1 1/8", 3/16", 1/4" and 5/16" and Scraper #2 3/8", 7/16", 1/2" and 5/8". Each scraper is 5" long x .032" thick and is made from CS80 steel hardened to 44-46 Rockwell.

154518 **\$16.99**



LYNX Scraper Set

LYNX Cabinet Scraper Set will leave a smooth surface without the tedium and expense of sandpaper. Available in four different styles for flat, concave, and convex shapes of varying radii. The straight is 2 1/2" x 5", the convex/concave is 2" x 6", the gooseneck is 2 7/8" x 4 5/8" and the double-curved is 2 3/4" x 5 1/2". Our scrapers are made of properly tempered .80mm high-quality steel.

147419 set of 4 **\$21.99**

The Best Epoxy On The Market Today!



SYSTEM THREE® Epoxy

The Best Epoxy On The Market Today!

This general-purpose epoxy system, with a complete line of additives, gained wide acceptance in the wooden boat building and repair industry, where lives depend on the quality of the adhesives used. Because of the strength of the bond, this system is especially useful for laminated applications like sled runners, structural beams, strip canoes, surf/snow boards or waterproofing and fiberglassing, cracked concrete oil well linings in Alaska, lobster tank linings, pianos, guitars, outside wooden signs and furniture. Resin and hardener are mixed in an easy 2:1 volume ratio and may be mixed with fillers for better flow control and gap filling. Included with each epoxy system is a FREE copy of System Three's "The Epoxy Book" which covers use and application.

Epoxy Resin is the base for all epoxy coating and gluing applications. Mix 2:1 with hardener.

- 100106 epoxy resin, quart.....\$28.99
- 100107 epoxy resin, gallon.....\$89.99

Hardeners. System Three derives its name from the three different hardeners available. The hardeners may be mixed with each other to "fine-tune" the pot life and working time to suit your particular application. **Hardener #1** for use down to 35° F, even under damp conditions. Pot life at 77° F is 15 min. **Hardener #2** general-purpose hardener for 60° F to 85° F, in damp or dry conditions. Pot life at 77° F is 30 min. **Hardener #3** for applications in high temperatures which require increased open assembly time. This hardener's best use is as a mix with Hardener #1 or #2 to slow cure time (increase working time).

- 124522 hardener #1, pint.....\$24.25
- 124523 hardener #1, quart.....\$37.99
- 124524 hardener #2, pint.....\$24.25
- 124525 hardener #2, quart.....\$37.99
- 124526 hardener #3, pint.....\$24.25

Plunger Pump Set screws onto epoxy containers and delivers 1 oz. per stroke for resin and a 1/2 oz. for hardener. Easy dispensing and accurate mixing! Pump fits gallon, quart, and pint containers.

- 124533 (A).....\$12.99

Fillers And Additives.

The low viscosity of epoxy makes it a poor gap filler. Additives are necessary to thicken the epoxy and change its flow characteristics. **Silica Thickener**

is an extremely fine powder used to create a very smooth, non-sagging, high-strength mixture. **Wood Flour**, a very fine, filtered, wood by-product is an excellent all-around filler for creating glues and structural fillers. Wood Flour forms a coarser "epoxy" than silica thickener. **Phenolic Micro Balloons** are hollow, purple-brown phenolic spheres that are a great low-cost, low-density filler (ideal for areas requiring sanding). Wood Flour and/or Silica Thickener may be blended with Phenolic Microballoons to prevent sagging.

- 124527 (B) silica thickener, 90 grams.....\$8.50
- 124528 silica thickener, 14 oz.\$15.50
- 124529 (C) wood flour, 1 qt.\$7.75

Accessories

- 124531 (D) 10 grad., 12 oz. mixing cups \$6.50
- 124532 (E) mixing sticks (25)\$5.25



SYSTEM THREE® Mirror Coat™

This pour on, self-leveling, 2-part epoxy coating is designed to create a high gloss, clear, decorative, super hard finish that has more depth than any other topcoat. You can actually create "floating" objects in your finish by embedding them between coats. Perfect for bar and tabletops, de-coupage, small clocks, and crafts. Complete application instructions for an unbelievably clear, deep finish.



SYSTEM THREE® Epoxy Kit

Two part epoxies are the adhesive of choice in difficult joinery situations, and this intermediate temperature product works better than others at most common shop temperatures. Two part epoxies are the adhesive of choice in difficult joinery situations, and this intermediate temperature product works better than others at most common shop temperatures. Kit yields 1 1/2 pints.



- 128605\$36.50



SYSTEM THREE® Goof Proof Epoxy

System Three Goof Proof Epoxy brings ease of mixing and dispensing together in one system. It all begins with a Goof Proof Epoxy Cartridge containing one of System Three's 1-to-1 ratio mix epoxies. Load a cartridge into the companion Goof Proof Gun, attach a mixing tip, squeeze the trigger to advance the plunger, and out comes premixed epoxy you can use to fill voids, cracks and holes with ease or to put just the right amount where you need it for repairs. Reuse a partially empty cartridge by removing the tip and replacing the cap to preserve the remaining glue for another day, or simply toss an empty cartridge.

- 157311 Goof Proof Epoxy Gun only \$32.99
- 159189 T-88 1.6 oz. cartridge w/2 tips..\$12.99
- 159190 Quick Cure 5\$12.99
- 1.6 oz. cartridge w/2 tips.....\$12.99
- 143149 Epoxy Mixing Tip (6).....\$7.99

QuickCure 5 5-Minute Epoxy

Epoxies are the only adhesive to use when strong, fast bonds are required on wood, most metals, fiberglass, ceramics, concrete, glass, leather and many plastics. Use this two-part epoxy mix (equal portions of resin and hardener) for quick and easy results.



- 124270 1/2 pint.....\$22.99
- 124269 1 pint.....\$39.99

Glue Bottle Applicator Set

This complete set includes an 8-ounce storage bottle with storage cap, an applicator tip with cover for dowel holes, an applicator tip with cover for biscuit slots, and a 2 1/2" wide roller with an attached storage cap for flat surfaces.



- 143566 glue bottle set.....\$14.50
- 04H52 bottle & 2 1/2" glue roller only.....\$9.49

BarrelBond™

5-Minute Gel Glue, 2 oz.

BarrelBond is the best pen turner's glue we've used - ever. The two-part epoxy gel formulation is easy to mix and use, and the five-minute open time is enough to glue up multiple tubes. What else? It is gap filling, waterproof, flexible, easy to trim, easy to sand, non-sagging and has an unlimited shelf life. Our favorite features are the gap filling and flexibility, because when properly applied, these characteristics mean fewer pen blank "blowouts".

- 152719\$18.50



E-6000 Adhesive With Precision Tips

E-6000 is one of those miracle adhesives that can bond almost anything to another material, with some exceptions. The lengthy list of materials it works with includes metal, wood, fabric, glass, ceramic, polymer clay, brick, marble, concrete, fiberglass, metal, acrylic, polycarbonate, and PVC. It's an indispensable maintenance tool that permits the end user to repair and maintain equipment that may have been too expensive or difficult to do in the past, and it's a great craft adhesive as well. Includes three tips for pinpoint delivery of the adhesive just where it's needed.

- 159626 1-ounce tube\$7.99



WoodRiver® Disposable Glue Syringes

Have you ever ruined expensive glue injectors after forgetting, or failing, to clean them? If you have, then we have the answer for you - disposable glue syringes. They're inexpensive enough to throw away after every job, but durable enough to clean out and save. Perfect for placing glue just where you need it, whether it's in dowel holes, biscuit slots or delicate assemblies. Bag of 5.

- 148674\$6.29

Disposable Glue Brushes

These quality horse-hair brushes are indispensable tools for evenly spreading glue, paste, grease or other substances found in the shop. Metal handles are 5 1/4" long, coated in tin plate, and are clinched to firmly hold the 3/4" long stiff bristles. Two widths, 1/4" and 1/2", are available in packs of 48 each.



- 04Z41 1/4" width.....\$9.99
- 04Z51 1/2" width.....\$11.99

TITEBOND® III Waterproof Glue

Titebond III wood glue is waterproof, yet it cleans up with water. Eight minutes of open assembly time and offers an application temperature as low as 47°F.

145560	4 oz.	\$4.99
145561	8 oz.	\$6.50
145562	16 oz.	\$9.50
145563	32 oz.	\$14.50
145564	1 gallon	\$37.99



TITEBOND® Glue

This yellow aliphatic resin adhesive offers the fast set and handling ease of white glues, and tack-toughness-durability of hide glue. Setting time 10-30 minutes, depending on temperature and moisture of wood. Allow 24 hours for full-strength bond. Non-toxic, non-flammable.

07L41	8 oz.	\$3.99
08L21	16 oz.	\$4.99
08L31	32 oz.	\$7.99
08L41	gallon	\$19.99



Titebond Extend Wood Glue. The same aliphatic resin found in the original Titebond glue but formulated for slower set and longer open time.

140441	16 oz.	\$7.99
124511	1 gallon	\$27.99

TITEBOND® II Water-Resistant Glue

Water-resistant and needs no mixing! It's the first one-part glue to pass Type II water-resistant testing. Not for use under water. Freeze/thaw stable, paintable, solvent-free, and non-toxic.

08L42	8 oz.	\$6.29
08L43	16 oz.	\$7.50
08L45	32 oz.	\$9.99
08L44	gallon	\$24.50



Titebond II Dark Wood Glue. The same aliphatic resin found in Titebond II but specially formulated for darker woods.

08L46	8 oz.	\$4.99
08L47	16 oz.	\$7.50

Titebond II Extend Wood Glue. The same aliphatic resin found in Titebond II glue but formulated for slower set and longer open time.

140442	16 oz.	\$8.69
124512	1 gallon	\$28.99

TITEBOND® Liquid Hide Glue

Holds more than 3,500 lbs. per square inch. Moderate set time (usually over one hour depending on temperature and moisture) permits unhurried assembly of wood, cloth, glass, etc. Allow 24 hours for full-strength bond.

153818	8 oz.	\$7.99
146011	16 oz.	\$12.99



WOODCRAFT Liquid Storage Containers

Hold just about any liquid you use in the woodshop. Made of high-density polypropylene, complete with spout and tip. Great for glues, stains and finishes.

124564	8 oz.	\$2.69...\$2.42
124563	extra spout/tip	\$0.59



TITEBOND® Instant Bond CA Adhesives

Titebond Instant Bond Adhesive, has features not found in other CA glues. A two-year shelf life means your glue will last longer, triple distillation produces a superior quality product with a tensile shear strength of over 4000 psi, and a service temperature range from -65°F. to +200°F. Bottles feature no clog tips for ease of use. Available in a variety of thicknesses for multiple applications.

		2 oz.	4 oz.	5.5 oz.
	Assembly/Cure Time	\$12.50	\$22.99	\$11.99
A. Thin	5/3 sec.	149430	149431	
	Med. 7/5 sec.	149433	149434	
B. Thick	10/8 sec.	149436	149437	
		\$16.25	\$29.99	
C. Gel	30/20 sec.	149439	149440	
D. Inst. Bond Activator				158826



Instant Glues Cyanoacrylate adhesives are available in a variety of formulas to handle all your bonding needs for wood, metal, leather, rubber, glass, ceramics, and most plastics.

(A) **Special "T" Adhesive** is very thick, like mixed epoxy. It has gap-filling abilities with a slow cure for difficult alignment jobs. Like Super "T", it is great for "fixing" cracked blanks for turning. Cure time 30-50 seconds, 2 ounces, non-toxic.

08X31	\$11.99
-------	-------	---------

(B) **Super "T" Adhesive** has the consistency of syrup and will fill small gaps between parts. Bonding time 10-25 seconds. 2 ounces, non-toxic.

08X11	\$10.99
-------	-------	---------

(C) **Hot Stuff Adhesive** is water-thin and is used for bonding parts that fit together well. Bonding time 3-5 seconds. 2 ounces, non-toxic.

08X21	\$10.99
-------	-------	---------

(D) **Super-Solvent** will remove instant glues from hands, clothes, surfaces, etc. Not to be used as a thinning agent. 2 oz.

08X51	\$8.99
-------	-------	--------

Aerosol Accelerator is easier to use than a pump, holds almost 4 times as much liquid and doesn't evaporate. 6 fluid ounces, non-flammable, does not contain CFC's and can be stored anywhere.

144829	\$12.99
--------	-------	---------

Hot Stuff Pro Tips. Precision-control extension applicators attach to existing tip for pin point placement of CA glue.

127821	pro tips (12)	\$2.09
--------	---------------	--------

08X12	replacement nozzle & cap (2)	\$2.69
-------	------------------------------	--------

08X42	replacement spray pumps (2)	\$2.69
-------	-----------------------------	--------



HOLD HEET

Electric Glue Pot

This one-quart Hold Heet industrial strength glue pot takes all the hassle out of heating and using traditional water-based animal hide glues. An automatic thermostat maintains an optimum temperature of 140° to 150° F without the need for a water jacket around the container. The pot will not overheat or burn the glue, the interior container is removable for cleaning, and a wiper rod is included for scraping the sides of the pot. Grounded cord, 115V, UL approved, one-quart capacity. USA.

124068	\$134.99
--------	-------	----------

154191	(A) 192-gram strength, 1 lb.	\$26.50
--------	-----------------------------------	---------



Brooklyn Tool & Craft Hide Glue

Brooklyn Tool & Craft Hide Glue is a natural animal protein adhesive. It is supplied in the form of dry granules for mixing with water, then heating to form an excellent adhesive for lutherie, marquetry, veneering and cabinetry. BT&C hide glue comes in 1-lb. resealable bags and is available in three different gram strengths: 192, 251 and 315. Gram strength is a measure of strength, as well as open time, with the higher gram strength being the strongest and fastest setting. The 192's longer open time is perfect for marquetry and veneering, and it is considered by many as the best hide glue for first-time hide glue users. The 251 is considered the best for general woodworking and cabinetry, while the 315, with the shortest open time, is best suited for lutherie work and small repairs.

154191	192-gram strength (shown).....	\$26.50
--------	--------------------------------	---------

154192	251-gram strength.....	\$22.99
--------	------------------------	---------

154193	315-gram strength	\$22.99
--------	-------------------------	---------



Old Brown Glue

Old Brown Glue is fresh "hot" hide glue in a bottle. The liquid glue is made from hydrolyzed collagen and urea in small batches (literally made to order) with a one-year shelf life, which can be extended if kept in a refrigerator. To make "hot" glue, the manufacturer recommends heating the glue by putting it in the sunlight or a warm water bath for a few minutes, and we concur. This completely organic, nontoxic formula has a 30-minute open time and require to dry completely.

850380	5-ounce.....	\$8.99
--------	--------------	--------

850379	20-ounce.....	\$25.50
--------	---------------	---------



Silicone Glue Brushes

Out of the barbecue pit and into the glue pot comes the silicone glue brush. Tired of cheap, disposable brushes that sometimes leak bristles into your glue? Try these brushes made of top quality silicone trimmed to a shorter bristle length for optimum spreading of your favorite glue. Brush measures 6 1/4" long with four rows of approximately 1" long by 1 1/4" wide by 3/8" thick bristle area. Available as a single brush or a box of 40. Each 10+

154365	\$1.99	\$1.49
--------	-------	--------	--------



(B) Suede-Text Flocking Fibers, in eight attractive colors. 3 ounces covers about 15 square feet.

Color	3 oz.	
		\$14.75
medium blue	14X31
blue (light)	16Y66
brown	14X11
bright red	14X41
wine	17C22
emerald green	17C12
kelly green	14X21
black	16W43

(C) Undercoat Adhesive.

8 oz. cans, covers 15 sq. ft.

\$14.75 Each

14X61 med. blue	17H32 blue (light)
14X51 brown	14X62 bright red
17H42 wine	17H41 emerald green
14X52 kelly green	17H31 black

Suede-Text Flocking Supplies

Gives a beautifully soft, velvety finish that's far superior to felt padding and much less trouble to apply! There's no cutting or pasting required. Simply paint on a special under coat of adhesive, then spray on the Suede-Text fibers. They're specially prepared rayon, dyed in rich, fade-resistant colors and cut to a uniform 1/32" length. Your finished surface will be lustrous, evenly napped and soft to the touch, ideal for lining boxes or drawers, and for coating the bases of project pieces.

(A) Mini Flocker is easy to use. Just put a small amount of fibers in the tube and gently pump them on to your prepared surface.

127115 **\$6.50**

FAMOWOOD Wood Fillers

A woodworker's favorite because it "behaves like wood," Famowood dries fast, won't shrink, crack or crumble, and can be treated like wood. Sand, nail, screw, saw, or carve! Available in solvent- and water-based formulations. 6 oz. containers.

142681 solvent (pint) **\$9.25**

Solvent-Based		Water-Based	
\$4.99		\$4.99	
144339	alder	N/A	
142470	ash	N/A	
142471	birch	144346	
144340	cedar	N/A	
142875	cherry	142887	
142479	fir	N/A	
N/A	golden oak	144347	
142472	mahogany	N/A	
142473	maple	142491	
142474	natural	142488	
142475	oak	142489	
142476	pine	N/A	
142477	red oak	142490	
142478	walnut	142492	
144343	white pine	144348	
144344	white	144349	

QUIKWOOD Epoxy Putty

Combines the reliability and strength of 2-part epoxy wood repair materials in a single component. No measuring or stirring is necessary. Just pinch off a bit of the Quikwood "log" which contains both the filler and catalyst, and knead it with your fingers. It's now ready to fill nail holes, dents, rebuild carving mistakes, restore rotten wood voids, or reshape a decorative piece. For exterior or interior use. It can be sawed, drilled, carved, sanded, painted, and will not shrink. Cures in just 30 minutes.

17C71	neutral, 2 oz.	\$8.39
147102	neutral, 1 oz.	\$5.79
142517	pine, 1 oz.	\$5.79
142516	dark, 1 oz.	\$5.79

AQUA COAT

Clear Wood Grain Filler

Aqua Coat Clear Wood Grain Filler is a water-based, low odor gel that is easy to apply. Its quick drying formulation is easy to level out and sand with minimal shrinkage, making it the first choice for leveling out open grained woods like oak and mahogany. Because it is clear, it can go over stain and sealers while permitting grain and color to show through. With Aqua Coat, a mirror like, high build finish is easy. Dry time is 30-45 minutes.

857390	pint	\$18.99
159255	quart (shown)	\$34.99

TIMBERMATE Wood Filler

This is wood filler as it was meant to be! Timbermate is a unique, quick-drying, water-based grain filler and wood putty that accepts stain beautifully, can be tinted, does not shrink or crack. So how is it different? It never goes bad! If it freezes put it in the microwave to warm it up. If it dries out, add some water, stir and you're back in business. Timbermate recommends using only stainless steel or plastic tools to apply to avoid any reaction with low-grade steels that may turn the putty "black." Even if this happens, because Timbermate is not permanent until a finish is applied, simply add water to remove the stained filler, allow the area to dry, then sand off and apply the putty again. Literally, up until the moment that finish is applied, if you're unhappy with the result, the color or any reason at all...water it down and remove it.

841442	American cherry, 8 oz.	\$7.39
841443	Australian cypress, 8 oz.	\$7.39
841444	Brazilian cherry, 8 oz.	\$7.39
841445	chestnut, 8 oz.	\$7.39
841446	Tasmanian oak, 8 oz.	\$7.39
841447	mahogany, 8 oz.	\$7.39
841448	maple/beech, 8 oz.	\$7.39
841449	red oak, 8 oz.	\$7.39
841450	ebony, 8 oz.	\$7.39
841451	walnut, 8 oz.	\$7.39
841452	white oak, 8 oz.	\$7.39
841454	white, 8 oz.	\$7.39
148740	natural, 8 oz.	\$7.39
148741	natural, quart	\$17.89

Earlex® HVLP Spray Station Pro HV5500

With **BONUS 1.5mm Fine Finish Needle Kit - A \$49.99 value!**

The Earlex Spray Station Pro HV5500 features a new 650W motor along with an improved taper fan design, and a new direct path of air from the turbine to the hose. The Spray Station HV5500 produces airflow 42 CFM at 2.2 PSI for better atomization, spraying a wider range of finishes with less heat buildup for a more professional finish. Includes 2.0mm standard needle

152797 **\$339.99**

Accessories

148524	1.0mm needle kit	\$49.99
149726	1.5mm needle kit	\$49.99
148525	2.5mm needle kit	\$49.99
148526	1 qt. replacement pot	\$39.99



Earlex®

Steam Generator For Bending Wood

Use the power of steam with the Earlex Steam Generator to create new furniture designs and woodworking projects by steam bending wood. The compact electric steamer incorporates a 1.3 gallon tank, only requires 23 minutes to "steam up," and provides 137 minutes of steaming time per tank—plenty of steam for a small to medium size steam box. The Earlex kit includes a steam generator, 12 ft. cool running hose, 6 1/2 ft. power cord, steam box adaptor fittings and instructions for making a steam box.

851322 **\$69.99**



WAGNER

Home Décor Paint Sprayer

This little HVLP paint sprayer made believers of us. We sprayed chalk paint first; then milk paint, then clear water-based finish and then water-based stain. It simply sprayed anything we put into the cup, and we did it without reading the instructions – **but you should read the well illustrated and easy to understand and follow instructions for safety reasons- and because they do help.** The spray gun is a bleeder style gun, which means air passes through the gun all the time but no material (paint) does until the trigger is pressed, and it has pattern control and material flow adjustments to help save paint. The all-plastic gun and cup are easy to clean, so changing color is a snap and little maintenance is required. Comes with a 6" air hose and complete use and thinning instructions. So how does it perform? As an entry level HVLP sprayer it does everything so well it is hard to believe it costs so little. With a little care and practice, you'll be spray finishing, staining and painting in no time at all. Wagner has created a great "first step product" for those who are new to HVLP spraying.

161374 **\$79.99**

APOLLO Eco-4 Spray System w/E7000



Non-Bleed Spray Gun

The new Apollo ASI-HVLP Eco-4 is an efficient and affordable four-stage turbine powered Spray System for the small workshop owner. The Eco-4 delivers more power and pressure than other similar four-stage turbine systems and is much quieter. The new dual filter QT™ Quiet Technology enclosed in a case that allows full ventilation and air filtration for optimum performance and longevity. With more available atomizing pressure, you can spray an even wider range of coatings at recommended viscosities on wood projects, cars, boats, planes, fencing, farm equipment, machinery and more without having to thin your coatings or paints. The Eco-4 comes with a new Apollo E7000 HVLP non-bleed spray gun, 20-foot hose, easy carry handle, and Handi-Held™ spray gun docking station.

857608 \$749.00

Apollo Sprayers ECO-Mini HVLP Sprayer

It's all about performance, and Apollo Sprayers Eco-Mini delivers both performance (5.5 PSI) and value. Featuring a compact, lightweight design with ample airflow, twin filters, a gun docking station and a reliable three-stage turbine motor, the ECO-Mini provides ample power and pressure to spray the most popular coatings and finishes on the market today. Comes with the E7200 TrueHVLP™ non-bleeder spray gun and 20' hose with quick disconnects. If you're spraying finishes and looking to take the next step without spending a ton of money, the Eco-Mini is that next step. The ECO-Mini

APOLLO PRECISION-5 HVLP Spray System with 7500QT Spray Gun



Nothing compares to the new Apollo PRECISION-5 TrueHVLP Spray System. Its enhanced five-stage power and exclusive features put you in control of the most advanced TrueHVLP system for industries and applications demanding precision technology for a perfect finish. Features include: 10.0 PSI (0.69 bar) sealed pressure with a Pressure Control System (PCS™) that controls motor speed, voltage and amperage and adjusts automatically for altitude and barometric pressure to ensure precise atomizing pressure worldwide; Throttle Back Control (TCB™) that allows the highest available flow pressure and increased motor longevity; and the new LCD Message Center that displays accurate pressure, motor idle, temperature and an hour use meter. The PRECISION-5 also comes with the Handi-Hold™ Spray Docking Station to store, hold and transport your award-winning 7500QT Spray Gun that includes a 1.0 mm nozzle/needle. This unit sprays the widest possible array of solvent- or water-based coatings, as well as most specialized material like faux paints, latex emulsions and multi-spec coatings.

160017 \$1,796.00



is backed by a two-year warranty (parts and labor), as well as expert factory technical support.

161372 \$549.00



Apollo Sprayers PRECISION-5 HVLP Spray System, 7500QT Spray Gun & PRECISION-5 Accessory Kit

Kit includes the ASI Power-5 with 7500QT Gun and the ASI Power-5 Accessory Kit.

153509A \$1,983.85

Apollo Sprayers PRECISION-5 HVLP Spray System Accessory Kit

Get the most out of your PRECISION-5 HVLP Spray System with our PRECISION-5 Accessory Kit, which includes four Needles/Nozzles (0.8mm, 1.3mm, 1.5mm and 2.0mm), two Air Caps "A" and "C", a Master Spray Gun Cleaning Kit, and a Viscosity Meter.

159260 \$384.85

Apollo Accessories:

Repl. Air Filter Kit (2-pc.)

152655 \$34.99

Apollo Compressed Air Coupler
7500QT Spray Gun

154097 \$329.00

Rebuild Kit for 7500QT

152661 \$49.99

Apollo Latex Kit For 7500QT Spray Gun -

2.0 mm Needle/Nozzle Combo and "C" Aircap

- Optimized to Spray Latex Paint Like a Pro
- Perfect for Trim, Doors and Cabinets

152663 \$109.99



Clear Plastic Cans

Clear PET plastic paint cans make great storage vessels for custom mixed paints, dyes and stains, as well as holding anything from screws to old keys. They come with airtight lids like paint cans, and PET is impact resistant so if you drop one, you won't likely have a mess to clean up. Comes in quart, pint and half-pint sizes.

860624 (A) quart \$2.99

860625 (B) pint \$2.75

860626 (C) 1/2 pint \$2.50

Touch Up Brushes

Touch up brushes are often in scarce supply around the shop. Our brushes are inexpensive and come in a handy storage tube with 36 brushes - just the thing for a little glue, stain or finish. Use them for small repairs, small projects, or for the kids' watercolors.

159877 (D) 36 pieces \$11.99

2 1/2 Quart Mixing Pitcher

This 2 1/2 Quart Mixing Pitcher features mixing ratios and volume measurements screened onto the side. It is an inexpensive way to mix custom colors the same every time and load them into your spray gun or a container for later use.

860580 (E) \$5.99

Plastic Mixing Stick, 8 1/2"

The 8 1/2" PET plastic mixing stick is just the right length to stir anything up to a quart. It is easy to clean after use, since most everything just peels or washes off and PET doesn't affect color adversely, which is important when matching color.

853039 (F) ea. \$0.59

Buy 2 or more ea. **\$0.50**

Touch-N-Go Applicators

Our resealable, syringe type applicators feature a small dabber on the end and are perfect for applying a small amount of color or finish just where you need it. They're "travel tough," so if you need to go on the road, just load them up with finish and/or color. If you want to use the applicator for glue, just snip the dabber off. Each pack contains five syringes and ten dabber tips.

861134 (G) 5-pack \$11.99

E-Z Dabbers, 40-Count

Use these Dabbers on the end of a small plastic stick with stain, paint, finish and glue. They are just right when just a dab of something is needed for a fix or perhaps to remove a droplet. Forty dabbers come in a small resealable tube, which keeps them clean and ready to use.

159882 (H) 40-count \$10.99

WoodRiver® HVLP Spray Guns

If you own a compressor, there really isn't a cheaper or faster way to start spray finishing than this! These self-regulated, gravity-fed HVLP spray guns work right off your compressor. Both guns feature stainless steel needles and nozzles as well as adjustments for air, fluid and pattern. So simple to operate, they're almost "plug and spray," and they offer the advantage (because they are powered by an air compressor) of being powerful enough to spray a broad range of material.

The WoodRiver® Pro HVLP Gun

is a full-sized gun with a 1/4" air inlet and large capacity for big jobs. Comes with a 1.4 mm nozzle and 600 cc plastic cup. 28.8 - 51 psi recommended air pressure, 4.2 - 7.1 cfm Average Air Consumption, 7.1" - 9.8" Pattern Width at about 6"-7" from surface.

- 149388 (A) WoodRiver® Pro spray gun\$43.50
- 149389 (B) Pro 1000cc alum. paint cup \$11.75
- 149390 (C) Pro 600cc plastic paint cup.....\$6.69
- 149391 Pro 2mm needle kit.....\$13.50

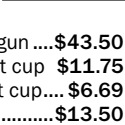
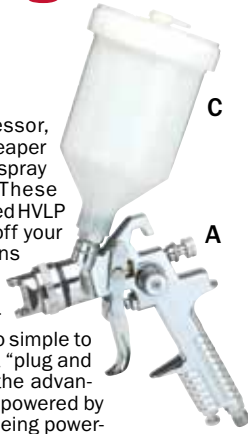

Tried & True Oil Finishes

Premium oil finishes are 100% solids and solvent free, making them safe for cutting boards, toys, and children's furniture.

Original Wood Finish is a general purpose finish made from a combination of highly polymerized linseed oil and beeswax.

Varnish Oil is highly polymerized linseed oil fortified with natural resin varnish to function as a semi-gloss topcoat that builds durability and sheen with applications.

Danish Oil Finish is pure, moderately polymerized linseed oil, the ultimate hand rubbed finish and a good choice for a satin finish.

	Pint	Quart	Gallon
Original Wood Finish	\$21.99	\$30.99	\$79.99
Varnish Oil	\$21.99	\$31.50	\$79.99
Danish Oil Finish	\$21.99	\$31.50	\$79.99

MYLANDS Finishing Products

For well over a century, Mylands has been producing high quality finishes with a difference - shellac is the prime ingredient. Long valued for its hardness and tremendous sealing properties, shellac's versatility allows it to be used to add warm tones to country furniture and high gloss when French polishing.

High Build Friction Polish. The most impressive turner's polish we have ever used. It builds quickly, drying almost instantly, complementing the natural beauty of the wood. When used without a sealer, a smooth sheen results. When used with Mylands Cellulose Sealer, a brilliant high gloss finish is easily attained. 500ml bottle.

813772\$25.50

Cellulose Sanding Sealer. A lacquer-based clear sealer and finish that dries to a soft sheen. It is specially formulated to work with any Mylands finishing product or by itself. A brilliant high-gloss finish can be achieved on turnings when used in conjunction with High Build Friction Polish; a rich matte finish when the waxes are used. This product does not contain shellac. 500ml bottle.

814153\$22.99

Wax. A unique formulation of the finest natural waxes (shellac, beeswax, and carnauba) in a toluene and xylene-free carrier. Can be used over virtually any finish to accentuate and protect. Applies easily and yields a lasting and lustrous shine. 16 oz.

813765 clear\$19.99

HOWARD Feed-N-Wax Wood Polish And Conditioner

This unique blend of beeswax, carnauba wax and orange oil enhances the natural beauty and depth of grain in finished and unfinished woods, but also prevents the wood and finish from drying out. Use once a month for regular maintenance or whenever the finish begins to look faded. Polishes to a soft luster and does not build up on the surface. 16-oz. bottle. USA.

154380\$7.99



BEHLEN Rockhard™ Table Top Urethane Varnish

Rockhard™ Table Top Urethane Varnish is the coating you need when you want a hard finish with maximum resistance to water, alcohol, chemicals, detergents and other damaging liquids. It's ideal for tables, chairs and cabinetry of all kinds - especially, where a hard wearing, abrasion resistant finish is desired. Available in quarts only.

- 154369 Gloss.....**NEW FORMULA!** \$24.99
- 154370 Satin.....\$24.99



Tru-Oil® Gun Stock Finish

Tru-Oil has been the professional's choice for gunstock finishing for more than 30 years. Combining a unique blend of linseed and natural oils, Tru-Oil dries fast and does not cloud, yellow, or crack with age, making it a perfect finishing product for woodworking projects too. This deep penetrating oil cures to form a tough, clear, hard finish that protects and enhances the beauty of fine woods.

- 142763 8 oz.\$17.25
- 152983 11 oz. aerosol.....\$13.50



HOWARD Butcher Block Conditioner

Butcher Block Conditioner is specialized care for butcher blocks, cutting boards, wooden bowls and utensils. The penetrating quality of the food grade mineral oil and the water resistance of beeswax and carnauba wax combine to rejuvenate wood, and the antibacterial waxes help seal and repair knife marks. Available in 2 oz. and 12 oz. bottles. USA.

- 158361 2 oz. (shown).....\$2.00
- 154382 12 oz.\$8.99



WATCO® Penetrating Danish Oils

Watco, the original Danish furniture oil, is back! It's rich finish is a result of a special blend of oils and resins that penetrate, seal, and preserve wood surfaces. Unlike plain linseed oils, Danish oil also contains resins which polymerize and dry in the wood and not on it. Watco finishes will not gum up in hot, humid weather. The Natural oil contains no pigments and will not color the wood. Coverage for all Watco finishes is 200-300 square feet per gallon.

	Pint	Quart	Gallon
natural	\$12.99	\$18.99	\$39.99
light walnut	159438	159437	813373
medium walnut	123978	123979	
dark walnut	123980	123981	
black walnut	124873	124875	
cherry	146093	146094	
fruitwood	124874	124876	
golden oak	123985	123986	
red mahogany	146447	146448	

MAHONEY'S Walnut Oil

This utility finish is filtered, 100% pure walnut oil. It will harden into a food safe satin finish for bowls, butcher blocks, wood utensils, and other wooden utility ware. Just wipe on or immerse and let it penetrate and harden for 24 hours. Leaves a great satin finish on all hardwoods and exotic woods. Contains no petroleum distillates and is completely safe for food contact after drying. 16 oz.

146022\$16.99



WoodRiver® 100% Pure Tung Oil

Tung oil, a drying oil like walnut and linseed oils, enjoys an almost mythic reputation for protecting and beautifying woods of all kinds. WoodRiver® Tung Oil, the best raw tung oil you can buy, is a completely natural product, filtered to remove the sediment but otherwise unprocessed and without additives. This product is 100% raw tung oil, so there may be variations in color and appearance. Do the environment a favor - use WoodRiver® Tung Oil for your projects.

- 153794 pint\$15.50
- 153795 quart\$23.99
- 153796 gallon (shown)\$64.99



ODIE'S Oil Clear

This Original Odie's proprietary blend of natural oils and waxes is a clear, non-yellowing, penetrating one-coat finish for floors, furniture and wood of all kinds, both indoors and out. Because it is nontoxic and food-safe, it also works well for wood utensils and cutting boards that come in contact with food. Plus, Odie's does an amazing job of stabilizing wet wood and minimizing checking, which makes it a must-have for woodturners.

856038 9 oz.\$28.99



HOWARD Butcher Block Oil

Howard's oil contains clear, odorless, tasteless, pure food grade mineral oil that exceeds FDA requirements for food contact, making it safe for all food preparation surfaces. Because it will never turn rancid, it is the perfect oil for seasoning cutting boards and butcher blocks. USA.

154381\$7.99





Cannot ship to California

WATERLOX Wood Finishes

Waterlox has been a family business for over 100 years—the business of making finishes for wood. Waterlox can be brushed, rolled, sprayed or applied in any manner you choose and delivers unparalleled protection, while bringing out the beauty in wood. Waterlox is available in two basic formulations **Water Clear Urethane** and **Tung Oil**. Water clear urethane, in satin or gloss, provides a tough, scratch-resistant, non-yellowing, crystal clear finish with soya oil for interior applications. **Original Tung Oil**, the original and best known Waterlox finish, produces a tough, durable, easily applied finish that penetrates, preserves and protects woods. The “Original” finish produces an amber color that gently darkens over time and is available in sealer, satin and gloss for interior applications. Original Marine Sealer and Finish is used on exterior applications. Low VOC Tung Oil formulation options, for interior applications, are also available in 350 VOC Sealer and 450 VOC Satin. **Note: Original and Low VOC products should not be used together due to a solvent issue.** For more information, visit woodcraft.com, your local Woodcraft Store or call our technical group at 800-535-4486. Coverage for all products is 125 sq. ft. per quart.

	Satin	Gloss	Sealer
Clear Urethane (A) 818260	\$34.99	\$34.99	
Original Tung Oil (B) 142450	\$42.99	\$36.99	\$31.50
Low VOC (D) 146079	\$40.50		\$37.99
			153508
	Finish	Sealer	
Original Marine Tung Oil	\$43.99	\$31.99	
			(C) 849929
		350VOC	
Original Sealer/Finish, gal. (E) 813299	\$75.99	\$114.99	841328

BRIWAX®

Produces a lustrous patina, not a glossy surface shine. Suitable for use as a finish on new wood or stripped furniture, as a reconditioner for old or damaged finishes, as a furniture wax for fine furniture and antiques or as an antiquing agent where the desire is to “age” a newly painted carving or project. Tinted waxes can be lightened or removed with the clear wax. 16 oz.



85C25 clear	\$20.99
85C26 golden oak	\$20.99
85C27 light brown	\$20.99
85C28 dark brown	\$20.99
145504 tudor brown	\$20.99
85C29 antique mahogany	\$20.99
143650 rustic pine	\$20.99
144609 ebony	\$20.99
844335 dark oak	\$20.99
844336 teak	\$20.99
844337 0000 steel wool 225gm	\$12.99

Brooklyn Tool & Craft Tiger Shellac

Imported from Germany, BT&C Tiger Shellac is a cat of a different stripe ... we know, a bad pun, but appropriate. Tiger Shellac is highly refined and dewaxed with an unmatched quality. We think this is the best shellac available in dry form, and it is perfect for any application – French polishing, sanding sealing, fine furniture finishing or finish restoration for antiques. Available in 1/2-lb. resealable bags.

158260 super-blonde (shown)	\$40.99
158261 blonde	\$35.99
158262 amber	\$31.99
158263 garnet	\$31.99



Brooklyn Tool & Craft Shellacs

Brooklyn Tool & Craft is quickly gaining a reputation among finishers as a supplier of high quality shellac. This is the standard range of the company's dewaxed shellac imported direct from India. It is less costly than the more expensive Tiger Shellac, but it is still a great shellac for most applications. Available in half pound bags only.

158346 blonde, shown	\$26.99
158347 garnet	\$21.00



Oil Of Cedar Wood

Restores the aroma of cedar lined chests and closets. 100% pure oil is distilled from aromatic red cedar. Rejuvenates the wood's odor and moth protecting qualities. May be used on any wood species, anywhere you want to deter insects.

14Z11 8 oz.	\$19.99
--------------------	---------



ANCHORSEAL 2 – The Next Generation Of Anchorseal®

For nearly 30 years, Anchorseal® has been the sealer of choice for Lumbermen, turners and furniture builders alike to protect their wood investment. Anchorseal 2 is a hybrid sealer that contains renewable, natural ingredients so there is less petroleum based material used in its production for a greener, more economical product that drips less, sticks better, has improved stability and, best yet, better than the original Anchorseal! Now, new and improved Anchorseal 2 is the choice for prevention of end grain checking.

150808 quart	\$13.50
150809 gallon	\$25.75



6 Mil Nitrile Gloves

Nitrile gloves provide inexpensive protection for your skin. At 6 mil thick, these nitrile gloves are really tough and they are powder free so there's no extra dust in the air to spoil your finish. During our own product testing, we found our 6 mil gloves to be resistant to “burn out” when finishing pens with Titebond Instant Bond CA Glue! These gloves are actually very reusable. Sold in boxes of 100 gloves, in three sizes.

152807 medium	\$15.99
152808 large	\$15.99
152809 extra large	\$15.99



Doctor's Woodshop Finishes

Doctor's Woodshop Finishes are based on three essential principles: wood should look like wood, not plastic, a finish should not obscure the natural beauty of the wood, and a finish should be safe to use. The Doctor's Finishes contain only one, two or all three of these products – shellac, wax and walnut oil – because they are safe to use, look natural and don't get cloudy. No solvents, driers or other additives of any kind are used.

Doctor's Woodshop Walnut Finishing Oil
Use this 100% all natural Doctor's Woodshop Walnut Finishing Oil as a finish or sanding lubricant. 16 oz.
847674\$16.99

Doctor's Woodshop Pens Plus
Doctor's Woodshop Pens Plus is a walnut oil and shellac friction polish combined with microaggregated microcrystal wax, which produces a hard, durable, shiny surface. 16 oz.
855499\$21.50

Doctor's Woodshop High Build Friction Polish
Doctor's Woodshop High Build Friction Polish is the new version of the classic oil/shellac polish but with walnut oil replacing the boiled linseed oil. 16 oz.
843051\$20.50

Doctor's Woodshop Microcrystal Wax Bowl Finish
For use as a friction polish on a lathe, this product produces a hard, restorable finish with a bright shine, which is completely food-safe and will last for a long time on salad bowls and other table ware. 16 oz.
855500\$13.99

RENAISSANCE Wax

Preferred by museums worldwide for protecting furniture, leather, marble, paintings and metal, this special blend of micro-crystalline waxes will not stain or discolor with aging. It is acid neutral, water and alcohol resistant. 200ml, 7 oz.
08G22\$29.99



NOT suitable for baking purposes

WoodRiver® Silicone Bench Mats

Our silicone mats resist most types of glue and finishes that woodworkers use, so it makes excellent glue-up and finishing mats for small projects, as well as sharpening mats for oilstones or waterstones. The mat keeps water and oil off your bench while providing a nonslip surface to prevent your stone from sliding. Plus the 2mm-thick soft, flexible mat also provides protection from dropped tools that might damage the bench surface. Bench Mats come in two sizes: 12" x 12" and 18" x 24". Two or more mats can be combined to protect a larger surface. **Not suitable for baking purposes.**

158721 12" x 12" x 2mm	\$9.99
158722 18" x 24" x 2mm	\$19.99
159604 23 1/2" x 60" x 2mm	\$49.99

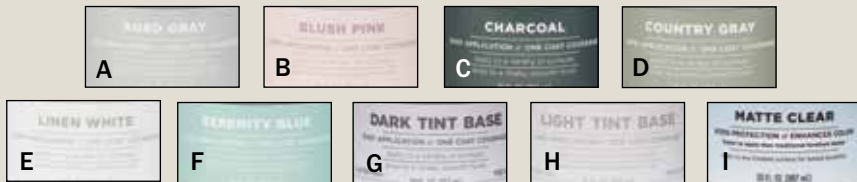

RUST-OLEUM® Chalked Paint

RUST-OLEUM® Chalked Paint is a water-based, ultra-matte finish that will revitalize furniture, cabinets, walls – your whole home décor. Use it alone as a simple covering paint or add decorative effects like distressing or dry brushing to give any project a one-of-a-kind look with a vintage feel. RUST-OLEUM is easy to apply with a brush or roller (spraying is not recommended), and in most cases it covers in one coat. A quart covers up to 150 sq. ft. Light and dark tint bases are also available for



custom mixing your own colors – we've found that Mixol Universal Tints work great.

Note: RUST-OLEUM Chalked Protective Matte Clear Topcoat is recommended for additional protection to keep your project looking good for a long time to come.

160839 (A) aged gray.....	\$14.99
160838 (B) blush pink.....	\$14.99
160840 (C) charcoal.....	\$14.99
160837 (D) country gray.....	\$14.99
160836 (E) linen white.....	\$14.99
160835 (F) serenity blue.....	\$14.99
160841 (G) dark tint base.....	\$14.99
160842 (H) light tint base.....	\$14.99
160843 (I) matte clear topcoat.....	\$19.99

Touch-Up Solutions® Furniture Care

Repairing those ugly scratches and gouges on your wood furniture from everyday use or moving is no longer a major chore, thanks to Touch-Up Solutions® furniture care products. New Touch-Up Aerosol Toners, available in 12 colors, ranging from light oak to black, and three new Touch-Up Aerosol Lacquers, work together with Touch-Up Pens, Fill Sticks, Burn-In Sticks, Clear Finish Pens, Clear Finish Aerosols and Burn Balm to make filling, covering and protecting damaged furniture easy. Whether you're rookie or professional simply coloring a nick or repairing a gash, Touch-Up Solutions has the product to fix it right the first time.



Touch-Up Solutions® Aerosols, 12 oz.

Repairing those ugly scratches and gouges on your wood furniture from everyday use or moving is no longer a major chore, thanks to Touch-Up Solutions

furniture care products. Aerosol Toners, available in 12 colors, ranging from light oak to black, and three Aerosol Lacquers will protect the repaired area.

861764 light oak.....	\$11.59
861765 golden oak.....	\$11.59
861766 burnt umber.....	\$11.59
861767 Van Dyke brown.....	\$11.59
861768 dark walnut.....	\$11.59
861769 cherry.....	\$11.59
861770 cherry fruitwood.....	\$11.59
861771 perfect brown.....	\$11.59
861772 brown mahogany.....	\$11.59
861773 dark red mahogany.....	\$11.59
861774 java.....	\$11.59
861775 black.....	\$11.59
160128 clear gloss lacquer.....	\$9.50
160129 clear semi-gloss lacquer.....	\$9.50
160130 clear satin lacquer.....	\$9.50

StopLossBags™

Evaporation and oxidation begin when you first open a can of finish, and each time you open the can it gets worse, eventually rendering any remaining finish unusable. Transferring the finish into one of our StopLossBags™ and squeezing out the air means the finish can be used to the last drop. StopLossBags™ are made from a special three-ply wall, each ply being a different material and thickness to prevent transpiration of water, alcohol, organic solvents and oxygen. Finish stays in, and oxygen stays out. Squeeze out only what finish you need, and the rest of the finish in the bag stays fresh until you need it. It's really that simple. StopLossBags™ are available in a four-pack only. When purchasing StopLossBags™ for the first time, we recommend you purchase either the Funnel or the Filler/Adapter Tube as well for easier transfer of finish to the bag.



160882 StopLossBags™ 4-Pack.....	\$11.99
160883 StopLossBags™ Funnel.....	\$6.99
160885 Extra Caps (4).....	\$1.25

RUST-OLEUM® Chalk Board Paint

Rust-Oleum® Chalk Board Paint converts almost any surface into a usable chalkboard. The possibilities for fun and creativity are limited only by your imagination. We have the standard black and green to replicate the old standby color boards, as well as an exciting new wrinkle – clear. Now, just cover any existing color with clear, add a contrasting chalk, and let the fun begin.



160007 black (shown).....	\$15.99
160008 green.....	\$15.99
160009 clear.....	\$15.99

FAMOWOOD® Glaze Coat® Kits

Glaze Coat® is a pour-on, high-gloss finishing epoxy that is perfect for home improvement, craft and woodworking projects. The ultra-clear, two-part Glaze Coat features an easy 1:1 ratio mix that yields a durable, waterproof and heat resistant coating equal to about 60 coats of varnish at 1/16" thick. It's great for coating tables and bar tops, preserving pictures, and imbedding items such as coins or rocks. Comes with complete instructions for use. Available in pint, quart and gallon kits.



160676 pint.....	\$14.99
160677 quart.....	\$24.99
160678 gallon (shown).....	\$69.99

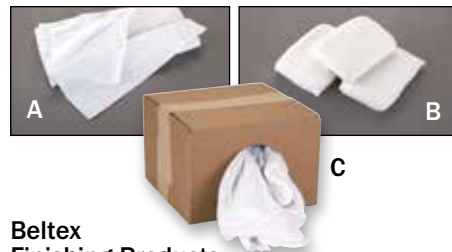

Beltex Finishing Products

Beltex supplies what woodworkers need – Tack Cloths, Wipers/Rags, Cheese Cloth, Staining Pads and various other sundries. These are the products that help finish and polish our projects. Whether you're finishing, staining, waxing, polishing or just wiping your hands, count on Beltex products.

159333 cheese cloth, 3 sq. yds.....	\$3.99
159334 (A) wipers 14" x 16", 10-pack.....	\$5.99
159335 (B) staining pads, 3-pack.....	\$5.99
159336 (B) staining pads, 12-pack.....	\$21.99
159337 tack cloths, 12-pack.....	\$14.99
159338 (C) knit wipers, 4 lbs.....	\$19.99
159339 knit wipers, 8 lbs.....	\$29.99

STAR Wiping Washed Jersey Knit Rags

A soft, absorbent cloth not only attracts liquids, but also "releases" the liquid when needed. The releasing characteristic of a good shop rag is important when applying stains and finish. These Washed Jersey Knit Rags were raised to be nothing but the finest shop rags. Star Wiping rags are made from a cotton blend - spun, woven, processed and boxed in the USA.



152652 1 lb.....	\$8.50
150924 4.5 lbs.....	\$24.99
150925 8.5 lbs. (shown).....	\$41.99



Finish Applicator Pads

These handy pads are made of a special woven fabric that holds a finish much better than a cotton cloth or rag. The 3"-diameter pad is a dense 3/16" thick and fits nicely even in a gloved hand, making it perfect for applying stains, oils, and waxes. The pads are a great alternative to cumbersome rags and help reduce waste. Sold in bags of 12 pads.

144622.....	\$5.99
-------------	--------

Microfiber Tack Cloth, 12-pack

You cannot use a regular tack cloth when finishing with water-based products, but our Microfiber Tack Cloths will work. These high quality cloths are inexpensive, washable and reusable, making them very economical. They also pick up a lot of sanding dust. Cloths are 12" x 12".



160679.....	\$14.99
-------------	---------

**COUNT ON US
FROM START TO FINISH™**

GENERAL FINISHES Polyurethane High Performance Water Based Finish

is formulated to resist foaming to prevent sags and runs like ordinary water-based finishes. Tack free dry time is only 15 minutes. Dry time between coats is 2-4 hours. High Performance Polyurethane, HPP also has a UV stabilizer to prevent it from breaking down in sunlight.



	Pint	Quart	Gallon
HPP Perform. Poly	\$17.50	\$27.50	\$72.50
HPP flat	153520...	850181	NA
HPP satin	85T59	85T60	811247
HPP semi-gloss	148414...	148413	148412
HPP gloss	85T61	85T62	813297
HPP flat		NEW!	854696

GENERAL FINISHES Gel Topcoat And Stains



Cannot ship to California

open up a world of easy-to-achieve possibilities for revitalizing, changing color, or achieving a beautiful finish for wood furniture, and cabinets. Just

wipe these oil-based gel products on with a foam brush or lint-free cloth, and wipe off the excess. The heavy bodied gel flows evenly (no drips or runs) for consistent color control, minimizing uneven penetration that causes blotching. Optional sanding between coats and a quick recoat time combine to produce an excellent "hand rubbed" look in less time with less effort. Available in 11 colors, General Finishes Stains can be combined with each other in any proportion to create custom colors. For extra durability and protection, use General Finishes Gel Topcoat or one of General Finishes' water-based products - PolyAcrylic Top Coat or High Performance Polyurethane Top Coat.

	1/2 Pint	Pint	Quart
American oak	826956	826957	826958
antique walnut	826959	826960	826961
black	159605	159606	159607
brown mahogany	826962	826963	826964
candlelite	826965	826966	826967
colonial maple	826968	826969	826970
georgian cherry	826971	826972	826973
golden pine	826974	826975	826976
gray	161194	161195	161196
java	826977	826978	826979
new pine	826980	826981	826982
nutmeg	826983	826984	826985
prairie wheat	826986	826987	826988
158720 java, gallon			\$69.99
	1/2 Pint	Pint	Quart
	\$9.99	\$14.99	\$22.99
clear satin topcoat	826989	826990	826991

GENERAL FINISHES Water Based Dyes

General Finishes dyes are ready to use, water based formulations designed to give you deep, rich colors without raising the wood grain. These easy to use dyes can be used straight out of the can, or can be diluted with the Neutral Base or water or intermixed with General's other water based stains and finishes to create a full palette of colors and tones.

	Pints	Quarts
Color	\$13.50	\$18.50
amber	148600	
blue	149541	
cinnamon	148601	150771
dark brown	148602	150772
ebony	148603	150773
empire red	148604	150774
green	149542	
light brown	148605	150775
medium brown	148606	150776
merlot	148607	150777
orange	148608	
pewter	NEW! 161397	161398
vintage cherry	148609	150778
yellow	148610	
reducer/neutral	148611	

GENERAL FINISHES Water Based Wood Stain

General Finishes Water Based Wood Stain spreads easily, can be repaired, blends effortlessly and has plenty of open time. Cleanup is easy.

161395 pint	NEW! \$12.99
161396 quart (shown)	NEW! \$18.99

GENERAL FINISHES Enduro-Var

Enduro-Var uses a colored urethane resin which imparts a warm glow to wood that darkens or ages over time and because it's an air oxidizing, air facilitates the cure. Once cured Enduro-Var produces an incredibly tough finish that is suitable for any interior application, including floors. A tough finished combined the ease of water based application makes this the finish of choice.



	Pints	Quarts
Gloss	151025	151026
Semi-Gloss	151027	151028
Satin	151029	151030

GENERAL FINISHES Butcher Block Oil (saf)

New from General Finishes. Great for wooden butcher blocks, cutting boards, utensils, even kid's toys. Simply flood the surface, allow the oil to penetrate, then wipe off the excess. Re-apply when surface shows wear.

124024 pint	\$10.99
-------------	---------



GENERAL FINISHES Arm-R-Seal

Arm-R-Seal topcoats are made with only the highest quality urethane resin, making them extremely durable and long lasting. They are formulated to be "wiped on" with a cloth or applied with a foam brush, thus eliminating drips and sags. They penetrate to provide deep down protection and that "natural" look. Arm-R-Seal is available in satin, semi-gloss, and gloss. For more information visit www.woodcraft.com.



	Pint	Quart	Gallon
Cannot ship to California	\$12.50	\$17.99	\$47.50
satin	85F03	85F08	811175
semi-gloss	85F02	85F07	816015
gloss	85F04	85F09	811176

GENERAL FINISHES Water Based Sanding Sealer

This newly formulated sanding sealer is for use under all General Finishes water-based coatings to create a clear sealing coat that sands easily and can be used to build a smooth foundation surface for final finishing. Also use this sealer to control uneven stain penetration and prevent blotching on hard-to-finish woods.

153403 quart	\$21.99
--------------	---------



GENERAL FINISHES Wood Turners Finish

Need a food-safe, durable, acid resistant, quick drying, easy to apply and VOC compliant finish? General has the product for you - Wood Turners Finish. This buffs out beautifully with as little as a single coat. Add multiple coats, and it begins to have depth like a hand polished lacquer or a multiple-coat CA glue finish. Don't let the name fool you, this finish is equally at home on furniture, and it sprays like a dream.

153331 8 oz.	\$11.99
--------------	---------



GENERAL FINISHES Salad Bowl Finish

General Finishes Salad Bowl Finish is non-toxic and food safe when dry and works well on wood surfaces that come in contact with food. Resistant to water and food stains, applied with a clean soft cloth.

125374 pint	\$12.99
125375 quart	\$18.99



Cannot ship to California

GENERAL FINISHES Pearl Effects, Pint

Pearl Effects are water-based decorative, acrylic pearlescent colors used to create specialty finishes. They may be applied over General Finishes Milk Paint, stains and water-based topcoats to create translucent metallic Pearl Effects. Pearl Effects are thick enough to cover a surface but may also be brushed on lightly to create a dusting effect. Experimentation is the key to using this versatile product. Easy water cleanup. Pints only.

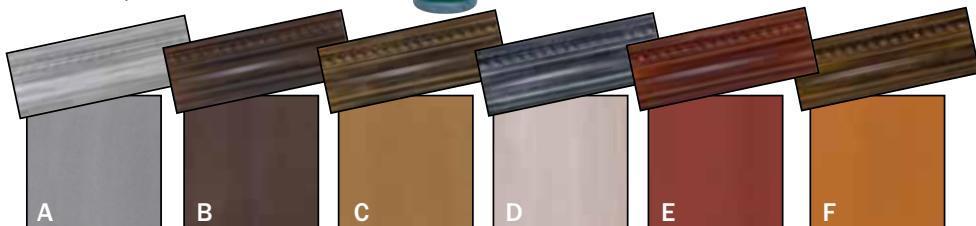

160650 (A) Argentine pearl	\$35.99
160652 (B) bronze pearl	\$35.99
160654 (C) burnished pearl	\$35.99

160656 (D) champagne pearl	\$35.99
160658 (E) copper pearl	\$35.99
160661 (F) tawny pearl	\$35.99

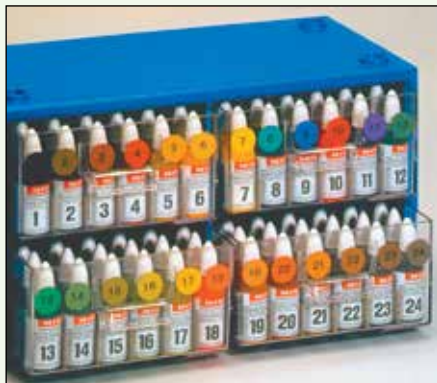

MIXOL Universal Tints

Mixol Universal Tints are the most concentrated, highest quality tints on the market today. They are compatible with most water, solvent, lacquer and oil-based stains, coatings, shellacs, epoxies, waxes, varnishes, wood fillers, etc... "Ease of tinting or mixing" is often cited as the main attribute to Mixol, along with the "sophisticated" color palette. Mixol tints are highly resistant to heat or frost damage, and they won't dry out or thicken (because they are binder-free) – so there is a very long shelf/shop life. Our assortment consists of 24 distinct colors, 10 of which are oxide-based (colors 3, 4, 5, 14, 19, 20, 21, 22, 23 & 24). The oxide-based colors are made from inorganic pigments which make them color-fast, fade-resistant and weather-proof. These oxide colors are ideal for exterior applications, or where UV fading may occur. Clean-up is very easy with soap and water. Mixol tints are not flammable or hazardous. Available in 20 ml bottles – a little goes a long way.

Mixol 10-Tone Woodworker's Set

This convenient package of 10 colors can create an unlimited variety of shades. Includes the most popular colors – black, umber, brown, oxide red, oxide yellow, blue, red, camel, dark brown, white and a color chart.

147216 10-tone set **\$53.99**
147164 24-tone set **\$121.99**

20ml	\$5.99
black (01).....	832386
umber (02).....	832387
brown (03).....	832388
oxide red (04).....	832389
oxide yellow (05).....	832390
olive green (15).....	832400
lime green (16).....	832401
mustard (17).....	832402
camel (19).....	832404
chestnut (20).....	832405
terra brown (21).....	832406
tobacco (22).....	832407
dark brown (23).....	832408
stone grey (24).....	832409
white (25).....	832410
green (08).....	832393
blue (09).....	832394
red (10).....	832395
fir green (12).....	832397
grass green (13).....	832398
oxide green (14).....	832399
maize yellow (06).....	832391
canary yellow (07).....	832392
violet (11).....	832396
orange (18).....	832403



HOMESTEAD TransFast Dye Powders

Developed by renowned furniture restorer and finisher Jeff Jewitt, these water-soluble dyes outperform any we have tried. Because the dyes contain no fillers or extenders, each 1 oz. bottle makes a half gallon or more of stain, nearly twice as much as most other dyes! Packaged in resealable bottles, you can use only the amount of dye necessary for the project at hand and not have to worry about the remaining powder leaking out of a paper envelope or absorbing moisture like other powdered dyes. Perfect for new work, repairs, or restoration, these deep penetrating colors can be combined to create virtually any shade without hiding the natural features of the wood. Stained surfaces can be coated with almost any type of finish to bring out the color you've applied. These easy-to-use dyes come with the best mixing and application instructions we have seen. Do not store liquid dyes in metal containers.

123824 dark red mahogany.....	\$12.25
123825 brown mahogany.....	\$12.25
123822 extra dark walnut.....	\$12.25
123823 medium walnut.....	\$12.25
123826 early American maple.....	\$12.25
123827 light oak.....	\$12.25
123828 mission brown.....	\$12.25
123830 antique cherry red.....	\$12.25

TransTint® Dyes

Developed by renowned restorer and finisher Jeff Jewitt, these new dyes are more versatile than any we've ever seen! TransTint dyes can be mixed with water for an economical, non-flammable stain or with alcohol for a fast drying, non-grain raising stain. For use as a toner or "shader", dyes can be added directly to water-based finishes and solvents to create a perfect match for touch-ups or a unique, customized finish. TransTint dyes can even be added to shellac, catalyzed lacquer and varnish, water-based lacquer and polyurethane, and most oil-based finishes. *Not for exterior use.* Each 2 oz. bottle yields about 2 quarts of dye-stain.



128481 honey amber..... **\$20.99**
128482 golden brown..... **\$20.99**

161426 coffee brown.....	NEW! \$20.99
128483 reddish brown.....	\$20.99
128484 medium brown.....	\$20.99
128485 dark walnut.....	\$20.99
128486 dark mission brown.....	\$20.99
128490 black.....	\$20.99
146956 amber.....	\$20.99
819063 cordovan.....	\$20.99
819064 brown mahogany.....	\$20.99
821810 bordeaux.....	\$20.99
821825 dark vintage maple.....	\$20.99
828382 red mahogany.....	\$20.99
128487 lemon yellow.....	\$20.99
128488 bright red.....	\$20.99
128489 blue.....	\$20.99
828383 purple.....	\$20.99
128491 bright green.....	\$20.99
128492 orange.....	\$20.99

BEHLEN

Water-Based Grain Filler

Behlen's water-based grain fillers are easy to apply, and dry considerably faster than do oil-based types. The quick dry feature allows for application and final sanding in a single day, versus the need for at least 24 hours (and preferably 48 or more) with oil-based fillers. Wipe down must be faster, but otherwise application is very similar to oil-based fillers. No VOCs is another great feature. Grain fillers are needed for a really smooth finish in open-pored woods such as red oak, walnut and mahogany.



818894 neutral, quart..... **\$21.99**

BEHLEN

Solar-Lux™ NGR Stain

The fade resistant, vibrant colors of Behlen's Solar-Lux™ dyes are translucent to enhance the grain pattern of wood, easy to apply and quick to dry, usually in 5 minutes or less depending upon application so they won't hold your work up. If needed, they can be thinned with the reducer and drying time increased with the addition of the retarder. Use only with adequate ventilation and an appropriate respirator such as our Multi-Purpose Respirator (141623). 16 ounce bottle.

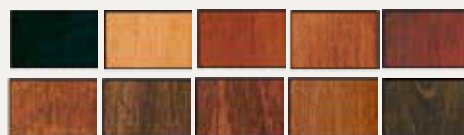

18X11 black, jet.....	\$13.99
18X21 fruitwood, golden.....	\$13.99
18X41 mahogany, med. red.....	\$13.99
18X51 mahogany, med. brown.....	\$13.99
18Y11 red, blood.....	\$13.99
18Y21 walnut, med. brown.....	\$13.99
18Y31 walnut, american.....	\$13.99
812691 brown, nutmeg.....	\$13.99
812427 cherry.....	\$13.99
812428 hickory.....	\$13.99
146098 retarder.....	\$13.25
146099 reducer.....	\$10.99



GENERAL FINISHES Milk Paint

For 2014, General Finishes adds 14 new palette colors to the premixed Milk Paint line it calls "furniture paint with soul." This high-tech, water-based acrylic paint is easy to apply, durable and simple to repair, while opening up an almost limitless array of color and finish options. Milk Paint is popular with DIYers as an inexpensive yet artistic way of transforming the look of a single piece of furniture or an entire room into something quite extraordinary. Mix colors or combine with General's water-based glazes or stains to create custom paints and decorative effects such as distressing, antiquing, faux marble, rag rolling and color washing for truly stunning results. Visit www.woodcraft.com to find a store near you. Check out www.blog.woodcraft.com and www.facebook.com/WoodcraftWoodworking for more decorating ideas.



	Pint	Quart
antique white	825755	825756
basil green	828536	828542
buttermilk yellow	825753	825754

	Pint	Quart
brick red	825757	825758
coastal blue	148933	146816
coral crush (A)	159017	860590
dark chocolate	857886	857887
driftwood (B)	159019	159165
emerald (C)	159020	860588
halcyon blue (D)	159022	860587
holiday red (E)	159023	860585
Klein blue (F)	159024	860583
lamp black	825761	825762
lime green (G)	159025	860582
linen	828537	828543
millstone	828539	828545
patina green (H)	159026	159168
Persian blue	857889	857890
persimmon (I)	159027	860589
Queenstown gray (J)	159028	159167
seagull gray	857883	857884
snow white	825763	825764
Somerset gold	148936	146822
sunglow (K)	159030	860586
Tuscan red	148937	146824



Old Fashioned Milk Paint

The deep rich colors of Milk Paint authentically reflect those colors found on existing antique furniture and buildings. Milk Paint is made in small batches, using earth pigments. Modern paints cannot compare with the colors and the texture of the finish for achieving the "old" or "country look" of Colonial or Shaker furniture and interiors. And, like the paints used hundreds of years ago, these colors will not fade. Milk Paint will produce an antique uneven matte surface when first applied. You can also create a semi-gloss look by simply burnishing the painted surface. Milk Paint is packaged in a dry powder form allowing you to control the thickness of the paint for use as either a wash/stain, full cover coat, or for stenciling. As in originally produced home-made milk paint, this product uses milk protein, lime, clay, and earth pigments such as ochre, umber, iron oxide, lampblack, etc. Milk Paint is environmentally safe and non-toxic when dry. It's safe for children's furniture and toys, and can also be used for interiors of homes of people who are



allergic to modern paints. Packaged as a powder, you add water to make one pint of liquid.

811624	barn red	\$13.99
811180	Salem red	\$13.99
811182	pumpkin	\$13.99
811625	marigold yellow	\$13.99
811151	mustard	\$13.99
811181	bayberry green	\$13.99
811627	tavern green	\$13.99
811628	Lexington green	\$13.99
811631	sea green	\$13.99
811152	federal blue	\$13.99
811153	soldier blue	\$13.99
811154	slate blue	\$13.99
811630	pitch black	\$13.99
811626	buttermilk	\$13.99
811155	oyster white	\$13.99
811629	snow white	\$13.99
146711	salmon	\$13.99
146712	driftwood	\$13.99
146713	chocolate brown	\$13.99
146714	light cream	\$13.99

Extra-Bond is a concentrated acrylic. It can be mixed with the first coat of Milk Paint to promote adhesion to surfaces other than bare wood. Non-toxic. **813376** 1 pint.....\$12.99

Milk Paint Crackle Finish is a water-based finish that will give your project a weathered look. **811156** 1 pint.....\$19.99



WoodRiver® Pallet Knives

Palette knives are great for mixing putty or epoxy, spreading glue and for making small repairs. WoodRiver® knives have durable wood handles with flexible, yet tough, stainless steel blades so they're easy to clean and almost maintenance free. Each set comes with four different profiles. Just pick the one best suited to the job at hand.

153921 4-piece set \$9.99

GENERAL FINISHES

Flat Out Flat Topcoat For Chalk/Milk Paint

General Finishes is always on the cutting edge with products for professionals and DIYers alike that deliver superior performance and are easy to use. Flat Out Flat, a clear, flat, water-based topcoat, is their latest innovation, a response to the durability issue with chalk paint and milk paint. The very ingredient that gives these paints their velvety look and powdery feel works against them in the durability department, especially chalk paint that can at times rub off on you if you brush up against it. Although wax can be used to increase chalk paint's durability, it requires frequent reapplication. General Finishes' solution: Flat Out Flat Topcoat, a finish designed to preserve the look, feel and color while increasing the durability of milk paint and chalk paint with a single coat. Flat Out Flat dries in about two to four hours under normal conditions. Coverage is about 75 sq. ft. per pint, and cleanup is easy with warm soapy water.



161276 pint \$16.50
161277 quart, shown \$27.50

GENERAL FINISHES

EF Extender

EF Extender is a wetting agent designed to slow the drying time and reduce the viscosity of all General Finishes water-based stains, sealers, finishes, paints and glazes. Extender reduces brush marks and overspray, as well as enhancing open time, which makes creating faux effects such as marbling easier. It mixes easily without generating foam or air bubbles. Comes in a 16 oz. bottle.

811243 \$10.99



Basic

Airbrush Kit

Couple this basic airbrush with a compressor or "canned gas," and you have everything you need to start spraying. Great for small projects and turnings, and useful when using waterborne finishes like General's Wood Turners Finish. This airbrush has an operating range from 15 PSI to 50 PSI, so start at 30 PSI and adjust up or down, depending on the material being sprayed. Kit contains a basic single action, siphon fed airbrush with a 3/4 oz. jar, 5' air hose, 1/4" coupler and a Propel regulator cap for using canned gas. Propel canned gas is a propellant used with airbrushes when a compressor is not available.

153568 airbrush kit \$10.49



Shop Pack

36 China Bristle Brushes

These brushes are great for applying glue, applying stains, or general shop use. Avoid messy clean up - economical enough to throw out when you finish the job. The Shop Pack includes 12 each of 1", 1 1/2", and 2" brushes with unfinished wooden handles.

147276 \$22.50



Finishing

CrystaLac®

Super Premium Clear Finish

A water-based, exceptional interior resin blend that offers superb hardness, optical clarity, chemical and mar resistance. Recommended for "top" surfaces such as tables, bar tops, pianos and musical instruments. Can be brushed or sprayed. Covers approximately 500 square feet per gallon or 125 square feet per quart. It dries to touch in about 18 minutes, recoat in one hour.

	Quart	Gallon
	\$24.79	\$54.99
Gloss	160353	160354
Semi-Gloss.....shown	160355	160356
Satin	160357	160358

CrystaLac® Exterior Finish

is a water-based, flexible, UV stabilized, waterproof clear topcoat for exterior furniture, doors and crafts. or anywhere the surface is exposed to the elements. Coverage is approximately 500 square feet per gallon or 125 square feet per quart, dries to the

CrystaLac® Finishing Sealers, Fillers, Polishes, And Additives

CrystaLac® Sanding Sealer

seals wood grain fibers for easy sanding, while enhancing and warming the look of natural wood. Water-based, nontoxic formulation dries fast and minimizes raising the grain for easy sanding. Coverage is approximately 500 square feet per gallon or 125 square feet per quart, dries to touch in about 18 minutes, recoat in one hour.

160359 quart.....	\$26.99
160360 gallon	\$57.99

CrystaLac® Clear Wood Grain Filler

A clear grain filler that can be tinted with dyes or colorants. Just wipe on, trowel off and sand between coats, if multiple coats are required. Contains silica.

Use an OSHA approved dust mask.

160371 quart tub.....	\$25.99
------------------------------	----------------

CrystaLac® Stainable Paste Filler fills gouges, small holes, scratches and imperfections and easily accepts stain color. You can use this water-based, environmentally safe and low VOC formulation filler for all your projects.

160372 quart tub.....	\$25.99
------------------------------	----------------



Space Balls™

These simple, yet effective objects center solid panels, then compress as the panel expands. They stop panel rattle and help eliminate cracking glue joints. Space Balls are 0.26" in diameter to match the cut of standard stile and rail bits. 8-10 Space Balls recommended per door. 100 per package.

142284	\$6.29
---------------------	---------------

CrystaLac® PolyOxide Wood Floor Finish

Gymnasium-tough, non-yellowing, water-based polyurethane U.V. stabilized and fortified with aluminum oxide for exceptional durability. Finish can be brushed, sprayed, or mopped on with a lamb's wool applicator. The finish dries to the touch within an hour, and additional coats can be applied every two hours. For best results, apply when temperature is between 60° and 80°. Coverage is approximately 400 square feet per gallon or 100 square feet per quart.

	Quart	Gallon
	\$27.99	\$65.99
Gloss	160361	160362
Semi-Gloss.....	160363	160364
Satin	160365	160366

touch in approximately 15 minutes, recoat in two to four hours.

	Quart	Gallon
	\$31.99	\$79.99
Gloss	shown 160367	160368
Satin	160369	160370

More Finishing Supplies,
See Pages 115-121

CrystaLac® Viscosity Reducer

is designed for thinning all CrystaLac® coatings. It enhances spray atomization and improves flow out and leveling.

NOT for use as a brush or spray gun cleaner.

160373 quart bottle.....	\$13.50
---------------------------------	----------------

CrystaLac® Retarder is formulated to slow and extend the drying time of CrystaLac® coatings, which is especially helpful for hot and humid conditions.

160375 quart bottle.....	\$13.50
---------------------------------	----------------

CrystaLac® Surface Conditioner

removes sanding dust, debris and oily fingerprints, prevents fish eye, and promotes inter-coat bonding. Apply a generous amount to a soft, clean, lint-free cloth, and simply wipe the surface with the grain. Repeat with a new cloth if required. *DO NOT apply to bare wood.*

160377 quart bottle.....	\$13.50
---------------------------------	----------------

CrystaLac® Finishing Polish imparts a rich luster and deep grain "hand rubbed" appearance to waterborne finishes of all kinds. Apply with a soft cloth, rubbing lightly over the finished surface, and continue buffing until dry. *DO NOT apply to bare wood.*

160379 quart bottle.....	\$26.99
---------------------------------	----------------



Painter's Halo

Painter's Halo is a silicone ring designed to fill the trough on the rim of a round can of finish or paint, to keep it free from the can's contents. It works really well, whether you're pouring or using a brush, plus it's durable and easy to clean because it's made from silicone. Fits standard quart and gallon cans.

154197 fits quart cans	\$4.99
154198 fits gallon cans	\$8.99

WoodRiver® 150 Plus

1/4" x 20

Jig Hardware Kit

This 150 Plus piece kit will be a great asset in the shop. Never worry about having the correct jig and fixture for making your own custom clamping and holding devices; you'll save money and work more efficiently. Steel plated studs and brass threaded inserts assure strong reliable holding power, while plastic molded knobs provide a comfortable grip. This kit contains 4 four-arm knobs with through hole, 6 four-arm knobs with stud, 4 five-star knobs with through hole, 4 four-arm knobs with insert, 3 ergo-style knobs with through hole, 4 T-style knobs with stud, 6 T-style knobs with insert, 16 threaded brass inserts, 16 T-nuts, 10 oval nuts, 16 sliding T-nuts, 8 hex bolts (1½" long) with washers, 20 T-bolts 1¾" long, 20 T-bolts 2¼" long and 20 T-bolts 3½" long. **Save over 30%** when purchasing this kit.

152866	\$84.99
---------------------	----------------



Lift-O-Mat®

Gas Springs

Lift-O-Mat gas springs from STABILUS are the perfect solution for lifting, holding or lowering heavy doors and lids. Kit includes two gas springs (silver) with four end fittings for mounting in wood (screws not included). Choose springs based upon the door height and weight combination guidelines shown below. Always verify your actual height and weight combination with a functional check prior to use.

152640 100.....	\$41.99
152641 150.....	\$41.99

Door Height	Door Weight			
	5-7 lbs.	8-10 lbs.	11-13 lbs.	14-20 lbs.
10½" - 12"	100	100	100	150
13" - 18"	100	100	150	N/A
19" - 24"	100	150	N/A	N/A

Glider Bracket Hardware

Glider Bracket Hardware is a set of four (4) glider brackets that fit on most gliders and can be used to replace old worn or broken brackets. Our glider brackets have special sealed bearings to eliminate squeaking. Measures 7½" between centers with 1¼" offset. The brackets mount with common ¼"-diameter bolt.

153233	\$20.99
---------------------	----------------

Soft Stem Bumpers

Bumpers are used to soften impact and reduce noise from abrupt closing of cabinet doors and drawers. Requires a 5mm hole. Package of 8.

153488	\$2.39
---------------------	---------------

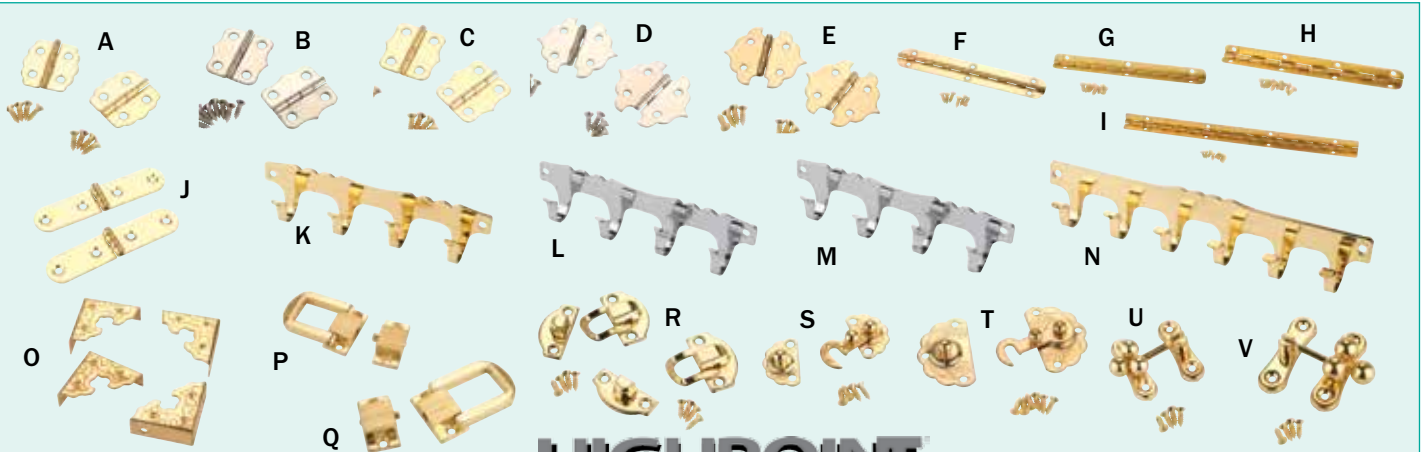

Images not to scale

HIGHPOINT®

Small Box Hardware

HIGHPOINT® box hardware is economical, small-scale hardware for jewelry boxes, humidors, keepsake boxes, etc., and is easy to affix with the mounting screws and pins included.

- 158421 (A) box hinge
23mm x 22mm brass, pair **\$2.49**
- 158422 (B) box hinge
24mm x 24mm nickel, pair **\$2.49**
- 158423 (C) box hinge
24mm x 24mm brass, pair **\$2.49**
- 158424 (D) box hinge
34mm x 29mm nickel, pair **\$2.49**
- 158425 (E) box hinge
34mm x 29mm brass, pair **\$2.49**
- 158426 (F) piano hinge
102mm x 17mm brass, each **\$3.99**
- 158427 (G) piano stop hinge
96mm x 7mm brass, each **\$2.99**
- 158428 (H) piano stop hinge
115mm x 9mm brass, each **\$3.99**

- 158429 (I) piano stop hinge
200mm x 9mm brass, each **\$5.99**
- 158430 (J) utility hinge
56mm x 13mm brass, each **\$1.99**
- 158433 (K) key box 4-hook strip brass, ea. **\$2.99**
- 158434 (L) key box 4-hook strip nickel, ea. **\$2.99**
- 158435 (M) key box 6-hook strip nickel, ea. **\$3.99**
- 158436 (N) key box 6-hook strip brass, ea. **\$3.99**
- 158437 (O) filigree corners brass, 4-pc. ... **\$2.99**
- 158438 (P) small box catch brass, ea. **\$4.25**
- 158439 (Q) medium box catch brass, ea. **\$5.25**
- 158440 (R) snap closure
1 1/16" x 1 1/8" brass, pair **\$2.99**
- 158441 (S) hook latch
30mm x 22mm brass, pair **\$2.99**
- 158442 (T) hook latch
42mm x 35mm brass, pair **\$2.99**
- 158443 (U) ball clasp
1 1/4" x 1 1/4" brass, each **\$3.99**
- 158445 (V) ball clasp
1 1/2" x 1 5/8" brass, each **\$3.99**

(items below, not shown)

- 159056 90° stop hinge 2 19/32" x 1 17/32"
nickel, pair **\$5.99**
- 159055 90° stop hinge 2 19/32" x 1 17/32"
antique brass, pair **\$5.99**
- 159054 90° stop hinge 2 19/32" x 1 17/32"
brass, pair **\$5.99**
- 159053 90° stop hinge 2 1/16" x 1 1/8"
nickel, pair **\$4.99**
- 159052 90° stop hinge 2 1/16" x 1 1/8"
antique brass, pair **\$4.99**
- 159051 90° stop hinge 2 1/16" x 1 1/8"
brass, pair **\$4.99**
- 159062 105° stop hinge 8" nickel, ea. **\$4.99**
- 159061 105° stop hinge 8" ant. br., ea. ... **\$4.99**
- 159060 105° stop hinge 8" brass, ea. **\$4.99**
- 159059 105° stop hinge 2" nickel, pair **\$3.99**
- 159058 105° stop hinge 2" antique, pair **\$3.99**
- 159057 105° stop hinge 2" brass, pair **\$3.99**



Blind Shelf Supports

A pair of these blind shelf supports will invisibly hold a 1" or thicker shelf. Each mounting plate is anchored to the wall studs with two flathead screws, and the projecting 5"-long hex posts slip into 7/16" holes drilled in the back side of the shelf. Even if the holes end up slightly undersized, the corners of the hex post will cut their way in. The design ensures that the alloy steel coupling screws remain tensioned between the posts and inserts in the plates, yielding a respectable capacity of 100 lbs. for a 4" deep shelf and up to 50 lbs. at 8" deep. By adding additional supports on shelves long enough to span more than two studs, each extra support adds 50 lbs. more capacity at 4" deep and 25 lbs. more at 8" deep. The simple instructions included make installation a snap. Sold in pairs. Mounting screws are not included.



159224 **\$15.99**



Thread Detective/ Thread Identifier

The Thread Detective is a precise and easy-to-use thread identifier for both nuts and bolts and let you distinguish between similar threads in Metric, English Standard, and a combo of Metric and English Standard. They are equipped with a 3 3/8" (85 mm) ruler for measuring stud lengths. Inch Thread Identifiers contain nut and bolt sizes of 6-32, 8-32, 10-24, 10-32, 1/4"-20, 1/4"-28, 5/16"-18, 5/16"-24, 3/8"-16, 3/8"-24, 7/16"-14, 7/16"-20, 1/2"-13, and 1/2"-20. Metric Thread Identifiers contain nut and bolt sizes of M4x0.7, M5x0.8, M6x1.0, M8x1.0, M8x1.25, M10x1.0, M10x1.25, M10x1.50, M12x1.25, M12x1.5, and M12x1.75. The Combo Thread Identifier Set unites all thread sizes from both the Metric and Inch versions.

- 158931 (A) SAE/Inch **\$20.99**
- 158932 (B) Metric **\$20.99**
- 158933 SAE and Metric Set **\$35.99**

Jumbo Thread Detective/ Thread Identifier

- 160072 SAE/Inch **\$19.99**
- 160073 Metric **\$19.99**
- 160074 SAE and Metric Set **\$35.99**

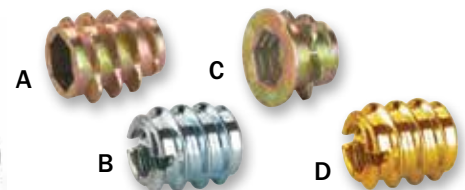

HIGHPOINT® Threaded Inserts

These inserts are for ready-to-assemble furniture, drawer pulls and wherever you need an easy-to-install threaded insert. Large teeth give increased holding strength in particleboard and end-grain applications. Simply drill a pilot hole, and thread in the insert.

Hex Drive

- 159280 (A) 1/4" - 20 TPI, 5/16" pilot **\$6.99**
- 159281 5/16" - 18 TPI, 3/8" pilot **\$6.99**

Slotted Drive

- 159282 (B) 1/4" - 20 TPI, 7/32" **\$6.99**
- 159283 5/16" - 18 TPI, 15/32" pilot **\$6.99**
- 159284 3/8" - 16 TPI, 1/2" pilot **\$6.99**

Low Profile

- 159285 (C) 1/4" - 20 TPI, 7/64" pilot **\$6.99**
- 159286 5/16" - 18 TPI, 1/2" pilot **\$6.99**

Brass

- 159287 6-32 TPI, 1/4" pilot **\$6.99**
- 159288 8-32 TPI, 1/4" pilot **\$6.99**
- 159289 10-24 TPI, 3/8" pilot **\$6.99**
- 159290 (D) 1/4" - 20 TPI, 3/8" pilot **\$6.99**
- 159291 5/16" - 18 TPI, 1/2" pilot **\$6.99**
- 159292 3/8" - 16 TPI, 1/2" pilot **\$6.99**
- 159293 3/8" - 24 TPI, 1/2" pilot **\$6.99**



NEW

HIGHPOINT® Side Rail Hinges

Side Rail Hinges are machined from $\frac{7}{64}$ " thick brass and are $\frac{5}{16}$ " wide and $1\frac{1}{2}$ " long. They stop at 95° and are designed for medium-duty application old in pairs. These finish coated hinges will stay bright and beautiful for years to come. Measure hinges carefully prior to cutting mortise.

- 161694 (A) w/o Stay $1\frac{1}{2}$ " x $\frac{5}{16}$ " \$19.99
- 161695 (B) with Stay 2 " x $\frac{5}{16}$ " \$21.99

HIGHPOINT® Economy Side Rail Hinge with Stay

These 2 " x $\frac{23}{64}$ " hinges are machined from stamped steel with a high quality polished brass finish. They do not require a mortise. Sold in pairs.

- 161696 (C) \$9.99



HIGHPOINT® U-Bracket Levelers

HIGHPOINT® U-Bracket Levelers provide maximum strength on extra heavy pieces. $\frac{3}{8}$ "-16 TPI x 3 "-long stems are easily adjusted with a screwdriver from the top or a wrench at the hex nut bottom. (Note: The stems are overall 3 ", and threaded portion is only $2\text{-}5/8$ ".) Glides have a $1\text{-}1/2$ " diameter, no-mar nylon swivel/tilting pad. Sold in packs of 4.

- 160759 4-piece \$14.99

HIGHPOINT® Solid Brass Wood Screws

High quality Flathead Screws. Box of 25.



- Slotted
- 159682 No. 1 x $\frac{1}{2}$ " \$1.99
 - 159683 No. 2 x $\frac{1}{2}$ " \$1.99
 - 159684 No. 2 x $\frac{5}{8}$ " \$1.99
 - 159685 No. 4 x $\frac{1}{2}$ " \$1.99
 - 159686 No. 4 x $\frac{5}{8}$ " \$1.99
 - 159687 No. 4 x $\frac{3}{4}$ " \$1.99
 - 159688 No. 5 x $\frac{5}{8}$ " \$2.49
 - 159689 No. 6 x $\frac{5}{8}$ " \$2.49
 - 159690 No. 6 x $\frac{3}{4}$ " \$2.49
- Phillips
- 159691 No. 1 x $\frac{1}{2}$ " \$1.99
 - 159692 No. 2 x $\frac{1}{2}$ " \$1.99
 - 159693 No. 2 x $\frac{5}{8}$ " \$1.99
 - 159694 No. 4 x $\frac{1}{2}$ " \$1.99

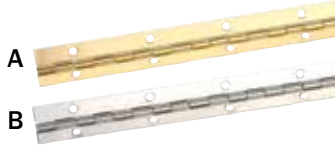

National® Piano Hinges

Piano or continuous hinges are long narrow hinges with the hinge pin running the length of the hinge. Generally used in applications where because of width and/or weight, it's advisable for support to use a hinge that runs the entire length of the joint such as in a piano (hence the name). National® Piano Hinges are made from steel for strength and durability. Each hinge has countersunk mounting holes every 2 inches, beginning 1" from each end, and comes with mounting screws. 1 hinge per pack.

- $1\frac{1}{16}$ " x 12" \$19.99
- 152154 (A) brass plated \$8.99
- 152155 (B) nickel plated \$8.99

- $1\frac{1}{16}$ " x 48" \$21.99
- 152156 brass plated \$21.99
- 152157 nickel plated \$21.99

- $1\frac{1}{2}$ " x 12" \$10.99
- 152158 brass plated \$10.99
- 152159 nickel plated \$10.99

- $1\frac{1}{2}$ " x 48" \$21.99
- 152160 brass plated \$21.99
- 152161 nickel plated \$21.99

WoodRiver® Stem Caster

Zinc finish. Black high-impact plastic wheels. Sold in pairs. Wheel Dia. $1\frac{1}{4}$ ", $1\frac{3}{4}$ "H. Capacity 30 pounds.

- 130231 \$6.29



HAFELE

Ball Point Hook Brass Plated

Update your kitchen or add a touch of class to your next cabinet project. Hafele offers a comprehensive portfolio of functional and fashionable themes that let you express the contemporary, traditional or transitional style you have in mind. 38mm exposed length.

- 159821 chrome \$1.99
- 159822 brass plated \$1.99
- 159823 matte nickel \$1.99



HIGHPOINT® Rubber Feet, 4-piece with Screws

Protect your countertop, desk or table, keep items such as cutting boards from sliding.

- 160473 7.5 x 17mm \$2.99
- 160474 6.8 x 12mm \$2.99



Economical Quadrant Hinge

Great for small jewelry boxes or humidors. Gold-plated hinge has $\frac{5}{16}$ " wide leaves with a $1\frac{1}{4}$ " hinge pin and $1\frac{1}{16}$ " leg. Mounting screws included, sold in pairs.

- 126965 \$8.99

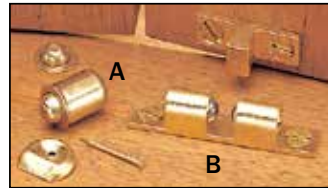

Ball Catches

(A) Bullet Catch. Light duty. Brass-plated steel. Includes strike plate brad. Bag of 10.

- 27H37 $\frac{1}{4}$ " diam. \$10.50

(B) Adjustable Ball Catch. Medium to heavy duty. Solid brass extrusion. Two sidescrews setspring/ball tension on catch release. For straight-on or side latching. Screws included. 10+

- $1\frac{1}{16}$ " L x $\frac{5}{16}$ " W. Each Each
- 27H39 \$3.75 \$3.38



Tabletop Fasteners & Pins

Tabletop Fasteners attach tops to aprons to allow for seasonal wood movement. When screwed to the bottom of the tabl top, these fasteners clip into a $\frac{3}{32}$ " (one saw kerf) slot in the apron. Screws not included.

- Bag of 8
- 159301 (A) ea. \$2.99

Table Pins align and hold your table leaves in position. Brass-plated steel pins press fit into an 8mm hole.

- Bag of 10 10+ Bags
- 27A30 (B) \$6.29 \$5.66

Stanley® Lid Supports

Stanley® folding supports are designed to hold a chest or box lid open, preventing the lid from slamming. Support is made of steel, with brass finish, and features a positive, "snap" into place when opened. Mounts $\frac{6}{8}$ " from hinge pin, sold as single, and includes screws.

- 152702 right-hand \$3.99
- 152703 left-hand \$3.99

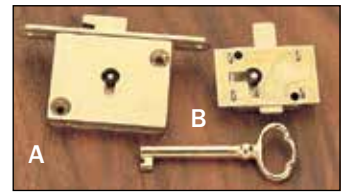

Chest And Cabinet Locks

(A) Full Mortise Chest Lock. Mortise size is $\frac{5}{16}$ " W x 2 " L x $1\frac{5}{8}$ " D. Lock Plate is $\frac{3}{8}$ " x $3\frac{1}{8}$ ". Strike and escutcheon are brass plated.

- 130261 \$9.99

(B) Surface Mount Cabinet Lock. Overall size is $1\frac{5}{8}$ " x 1 " x $\frac{3}{8}$ ". Brass plated, includes escutcheon.

- 130259 \$12.99

Stanley® Cupboard Catch

The Stanley® Cupboard Turn, or Catch, is designed for securing doors on wooded cupboards or cabinets and offers a traditional look. Catch measures $1\frac{3}{4}$ " x $1\frac{3}{4}$ " overall. Screws included.

- 152697 nickel finish \$6.99

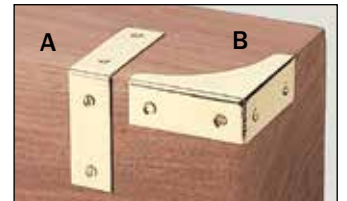

Chest Straps

Solid Brass, bright finish. Sold in pairs.

- Dimensions Each 4+
- 127389 (A) 2 " x $\frac{3}{4}$ " \$10.50 .. \$9.45

Chest Corners Solid Brass, bright finish. Sold in pairs.

- 127393 (B) 2 " x $\frac{3}{4}$ " \$17.75 \$15.97



Stanley® Chest Hinges

These Stanley® hinges are an excellent alternative to continuous hinges for your next blanket chest or toy box project. Hinge and screws are semi-concealed when lid is closed. Made for use on $\frac{3}{4}$ "-thick material, the hinge is $1\frac{1}{2}$ " wide. Flat leaf measures 2 " long; bent leaf measures $\frac{3}{4}$ " from pin and $1\frac{1}{4}$ " after bend. Sold in pairs with screws.

- 152700 brass finish \$8.99
- 152701 zinc finish \$8.99

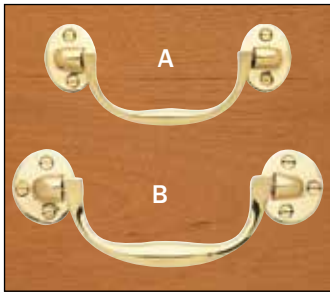

Chest Handles

Solid brass, sandcast with bright finish. Light-duty handle - 3 1/2" bail; heavy-duty handle - 4 1/2" bail. Handles may be used for lifting. Exercise care as weight rating is dependent on wood used. Each 4+

127398 (A) Lght.-duty **\$18.50 \$16.65**
127399 (B) hvy.-duty **\$35.99 \$32.39**



Period Swan Neck Pull

Solid brass, sandcast with bright finish. Hole Cntrs. Each

127351 3" **\$21.50**
127352 3 1/2" **\$21.50**



LATCH IT Stainless Steel Magnetic Latches

Keep doors and drawers securely closed with these magnetic latches that are perfect for boats, motorhomes, utility vehicles with cabinets, and workshops because they're non-mechanical! And they're easy to mount: two screws and you're done. Strong rare-earth magnets housed in stainless steel mounts create catches that will stand

HIGHPOINT® Bench Bolts

HIGHPOINT® Bench Bolts are perfect for assembling work-bench or other large knock-down furniture projects. Includes hardware to complete one bench - four bolts, brass nuts and washers (1/2" x 6" Hex Bolt; 13/16" Bolt Head that fits into a 7/8" hole; 23/64" Solid Brass Nut that fits in 1" hole in rail).

159649 **\$19.99**

HIGHPOINT® Knob And Pull Marking Template

Whether you're mounting knobs or pulls, these templates make alignment fast, easy and most important - precise! Simply select the hole that suits your needs, mark, drill and mount. It's as simple as that! With the HIGHPOINT® template for Drawers, simply measure the width of the drawer, and mark the top center of the drawer. The guide aligns with your mark and gives you the exact

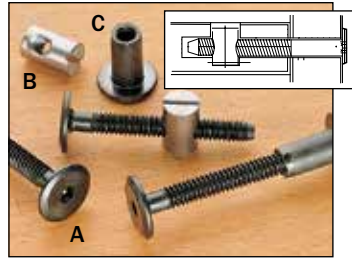

Knock-Down Hardware

(A) Connector Bolts. Use with cross dowels, connector nuts, or any common 1/4"-20 nut. Steel bolts feature 11/16" diameter, bevel-edged heads for extra surface support and low-profile design. Black oxide finish. Requires metric M4 hex wrench for installation. Available in 3 lengths for different stock thicknesses. Packs of 10.

Length	Pack of 10
06M40 1 1/8"	\$4.19
06K80 2"	\$4.99
06K90 3"	\$4.99

(B) Cross Dowels. Barrel nuts are solid steel, 16mm long (.630") x 10mm diameter (.393") with slotted end for in-hole alignment 1/4"-20 threaded hole is off-center. For use in 5/8" and thicker stock. Packs of 10.

Pack of 10

06K70 **\$3.19**

(C) Cap Nuts. Mounts on bolts for clean board-to-board joining of shelves and cabinet sides. Same head design as our bolts. 1/4"-20 internal thread. 5/8" L x 3/8" dia. body. Requires M5 hex key.

Pack of 10

06M50 **\$4.19**

up to outdoor or marine use.

159393 (A) 1" w/brkt.,

holds up to 40 lbs... **\$9.50**

159394 3/4" w/brkt.,

holds up to 20 lbs... **\$9.50**

159395 1/2" w/brkt.,

holds up to 10 lbs... **\$9.50**

159396 (B) 3/4" flush mnt.,

holds up to 20 lbs... **\$9.50**

159397 1" flush mnt.,

holds up to 40 lbs... **\$9.50**

HIGHPOINT® Bed Bolts

Set includes enough hardware to complete one bed - four bolts, brass nuts and washers (3/8" x 5" Hex Bolt; 11/16" Bolt Head that fits into 3/4" hole; 5/8" Brass Nut that fits in 1 1/16" hole in the rail).

159650 **\$14.99**

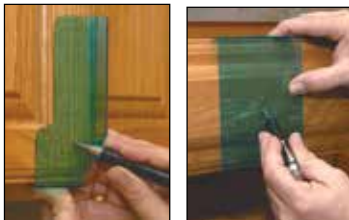

location of your pulls or knobs. Drawer template works on drawers up to 10" high. Cabinet Door Template has five knob and four pull positions.

160194 cabinet template..... **\$4.99**

160195 drawer template..... **\$4.99**



Heavy-Duty Leg Levelers

Perfect for cabinets, tables, or shelving units, these levelers feature a lipped mounting bracket that works to lift, support and create more stability. Small foot leveler, 1 5/16" diameter, comes in a set of 4 and has a pivoting steel base with plastic protective cap. Wide foot leveler, 2 3/8" diameter, is sold individually. Both are made of heavy-gauge, plated steel and use a #5 hex wrench for adjustment.

145840 small foot (4) **\$20.99**

Each 4+

142498 wide foot (1) **\$6.99 \$6.30**

Cabinet And Furniture T-Nut Levelers

Easy installation, bore a 1/2" dia. hole and hammer in the T-nut. 3/8"-16 TPI x 3 1/2" long stems are easily adjusted with a screwdriver from the top or a wrench at the hex nut bottom. (Note: The stems are overall 3 1/2", and the threaded portion is only 2 5/8"). Glides have a 1 1/2"-diameter, no-mar nylon swivel/tilting pad. Sold in packs of four.



160701 **\$7.99**

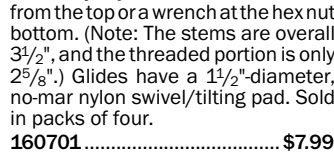

Corner Caster Set

This quick-mount caster set provides superior stability by supporting heavy furniture with brackets that easily secure to the corners of the frame. Each set will support 290 lbs. with 1 1/2" wide by 2 1/4" tall casters, holding furniture 1 1/4" off the ground. Black phenolic thermoset plastic wheels. Four casters per set, with screws.

153874 4-piece **\$15.99**



Corner Bracket Leveler With Lip

Provides cabinet frame support. 1/4"- 20 TPI x 1 1/2" long stems are installed in base units and adjust with turn of the nut. 1 3/8" diameter glides, non-marring nylon pad. 110-lb. capacity each. Screws included. Sold in packs of two.

153872 **\$9.99**

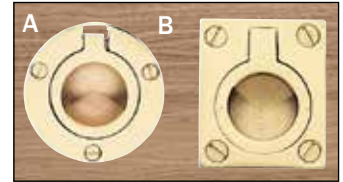

Flush Rings

Solid Brass, bright finish.

Dimensions Each

127384 (A) 1 1/2" dia. **\$18.99**

127385 (A) 2" dia. **\$28.50**

127386 (B) 1 1/2" x 1 1/4" **\$28.99**

127387 (B) 2 1/2" x 2" **\$29.99**

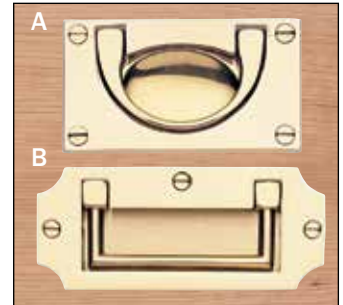

Chest Handles

Solid brass, sandcast with bright finish. Small handle 3 1/2" x 2". Large handle 4 1/4" x 1 3/4". Handles are decorative pull handles not to be used for lifting. Each 4+

127382 (A) sm. **\$28.50 ... \$25.65**

127383 (B) lg. ... **\$31.25 ... \$28.12**

Solid Brass Knobs

Provide a touch of classic quality to any piece of furniture. Polished and lacquered finish. Supplied with dowel screw for secure, easy installation.

Diam. Height Each 10+

02U21 3/8" ... 5/16" ... **\$8.50 ... \$7.65**

02U22 1/2" ... 7/16" ... **\$8.79 ... \$7.91**

02U23 5/8" ... 1/2" ... **\$8.99 ... \$8.09**

02U24 3/4" ... 9/16" ... **\$9.50 ... \$8.55**

130159 1" ... 15/16" ... **\$9.29 ... \$8.36**

HIGHPOINT® Table Leaf Locks

Plated steel locks provide a secure locking mechanism that works best for tables with alignment pins. Screws included.

159296 table leaf lock..... **\$3.99**

159297 HD table leaf lock ... **\$4.99**

159298 decorative table leaf lock, pair **\$3.99**

HIGHPOINT® Desktop Fasteners

14-gauge steel fasteners reduce effects of movement on an apron to surface wood joint. 1 1/4"-long x 5/8"-wide. 10 pieces. Screws included.

159303 **\$4.49**





BRUSSO Precision Knife Hinges. Straight hinges for overlay doors, offset L-hinges for flush-mounted doors. Use $\frac{5}{16}$ " wide hinges for small doors up to 12" x 24" and $\frac{3}{8}$ " hinges for medium doors up to 24" x 36". Screws included.

Style	W x L	Per Pair
145288 knife	$\frac{5}{16}$ " x $1\frac{5}{16}$ "	\$20.99
145289 knife	$\frac{3}{8}$ " x $1\frac{3}{4}$ "	\$27.50
145290 offset	$\frac{5}{16}$ " x $1\frac{3}{8}$ "	\$27.99
145291 offset	$\frac{3}{8}$ " x $1\frac{3}{4}$ "	\$35.99

BRUSSO Precision Box Hinges feature rectangular knuckles which stop the lid in a vertical position so it won't drop back. Hinge pins are precision-ground tool steel, with pin boxes that are first drilled, then reamed, for stain smooth fit and operation. Use in boxes of all types and small doors where the opening angle won't exceed 100 degrees. Screws included.



L x W Closed	Min. Stock Thickness	Leaf Thickness	Per Pair	
145286	$\frac{3}{4}$ " x $1\frac{1}{2}$ "	$\frac{5}{16}$ "	$\frac{3}{32}$ "	\$29.99
145287	$1\frac{1}{4}$ " x $\frac{5}{8}$ "	$\frac{7}{16}$ "	$\frac{3}{32}$ "	\$34.50



BRUSSO Jewelry Box Feet are the finishing touch on a finely crafted box. Install by gluing feet into a $\frac{5}{16}$ " diameter hole, $\frac{1}{4}$ " deep. Feet measure $\frac{9}{16}$ " total height, exposed foot height $\frac{3}{8}$ ". Solid brass.

145296 set of 4.....\$15.99



BRUSSO Brass Bullet Catches

Bullet Catches gently hold cabinet doors shut. Spring loaded balls align and index on strike plates. Light and medium duty. Milled from solid brass with stainless steel ball. Install easily. Sold individually.

Size	Each
145292 $\frac{1}{4}$ " dia., light duty	\$11.50
145293 $\frac{7}{16}$ " dia., med. duty	\$15.25



Drop-Leaf Hinges

Specifically designed for use in the construction of drop-leaf or harvest tables. Hinge measures $1\frac{1}{2}$ " wide x $3\frac{7}{8}$ " length open. Plain steel with $\frac{5}{8}$ " screws included. pair 10+

27125\$5.99\$5.39



Drawer Pull With Card Holder

Display the contents of your drawers with these decorative and functional label holder bin pulls. A unique alternative to customary cabinet hardware, these pulls may be used on any cabinet or piece of furniture. Slotted head wood screws are included. Pull measures $2\frac{1}{4}$ " x $1\frac{1}{4}$ "; window measures $1\frac{11}{16}$ " x $1\frac{13}{16}$ ".

154691 polished brass.....\$2.99
154692 chrome.....\$2.99
154693 dark copper.....\$2.99

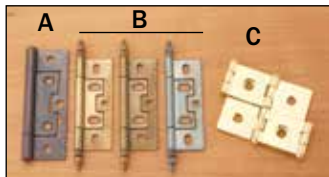

Non-Mortise Hinges

(A) **Cabinet Hinges.** Requires no cutting of butt mortises, just screw hinge to door and jamb. Heavy-gauge steel with statuary bronze finish. Sold in pairs with mounting screws.

W x L Closed	Per Pair
27G11 $\frac{5}{8}$ " x $1\frac{5}{8}$ "	\$2.25
27G12 $1\frac{1}{16}$ " x 2"	\$2.25
27G13 $1\frac{3}{16}$ " x $2\frac{7}{16}$ "	\$2.25
27G14 1" x 3"	\$3.75

(B) **Cabinet Hinges With Finials** in hand-rubbed brass, antique brass or silver finish. Sold in pairs with mounting screws. Size Finish Per Pair

130552 $\frac{7}{8}$ " x 2".....HRB.....\$7.25
130549 1" x $2\frac{1}{2}$ ".....HRB...\$6.99
130551 $\frac{7}{8}$ " x 2".....AB.....\$7.25
130548 1" x $2\frac{1}{2}$ ".....AB....\$6.99
130553 $\frac{7}{8}$ " x 2".....S.....\$7.25
130550 1" x $2\frac{1}{2}$ ".....S.....\$6.99

(C) **Double-Action Hinges** for $\frac{3}{4}$ " or $1\frac{1}{8}$ " thick panels, swings either direction. Polished brass or statuary bronze finish, includes mounting screws.

Panel Finish	Per Pair	10+
27G33 $\frac{3}{4}$ ".....PB....	\$5.50	\$4.95
27G34 $1\frac{1}{8}$ ".....PB....	\$5.29	\$4.76
27G31 $\frac{3}{4}$ ".....SB....	\$5.50	\$4.95

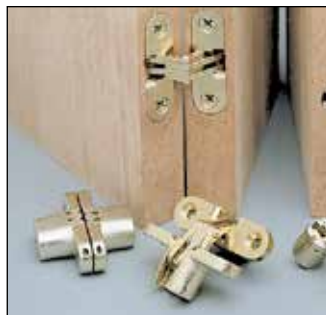

SOSS "Invisible" Hinges

Ideal when a flush, smooth surface with no visible hinge is required. Hinges are brass-finished zinc, open a full 180°, and have a laminated link construction that reduces friction for smooth operation. Installation instructions and mounting screws included. For light load-bearing applications.

Invisible Hinge for wood $\frac{3}{4}$ " or thicker. Use larger hinge for longer, wider applications.

W x L of Plates	Per Pair
06B44 $\frac{1}{2}$ " x $1\frac{3}{4}$ "	\$26.50
140472 $\frac{1}{2}$ " x $2\frac{3}{8}$ "	\$28.99

Invisible Hinge for wood $\frac{1}{2}$ " to $\frac{5}{8}$ " thick. Smaller hinge is perfect for boxes and small cabinets; larger hinge for all other applications.

03H33 $\frac{3}{8}$ " x 1"	\$26.50
140471 $\frac{3}{8}$ " x $1\frac{11}{16}$ "	\$28.99



Non-Mortise Invisible Hinges

Easy hinges to install – just drill the proper size hole, tap the hinge in flush and tighten the locking setscrew to expand the body of the hinge tightly in the hole. Solid brass with brass plated steel linkage. 180° opening.

Non-Mortise Hinge for $\frac{1}{2}$ " thick panels. Requires 10mm mounting hole.

27C11ea. \$6.25

Non-Mortise Hinge for $\frac{3}{4}$ " thick panels. Requires 14mm mounting hole.

27C12ea. \$7.25



HIGHPOINT®

Small Box Lock

This solid lock for small boxes includes an escutcheon key, top and bottom plates, all gold plated. The lock case is less than $\frac{1}{4}$ " thick, and the selvedge is $\frac{5}{16}$ " x $2\frac{3}{16}$ ". Comes with screws and escutcheon pins.

158444.....\$6.99

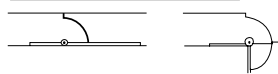

Table Hinge Installation

Table Hinges

Designed specifically for drop-leaf tables with rule joints. Extra-wide plates clear the hollows over the rounds on the molded-edge joints when the leaves are moved up into position. Drawn brass hinges are manufactured with brass pins. Screws not included.

L x W Open	Screw Size	Per Pair
16R41 $2\frac{1}{8}$ " x $1\frac{1}{4}$ "	#6	\$14.99
16R42 $2\frac{7}{8}$ " x $1\frac{1}{2}$ "	#6	\$16.99

Miniature Barrel Hinges

Make your own pen, pencil, or other small cases or boxes with these miniature barrel hinges! Precision 5mm diameter hinges are made from solid brass and feature smooth operating, finely machined mechanisms. Bags of 10.

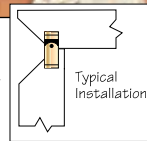

06R91\$8.99

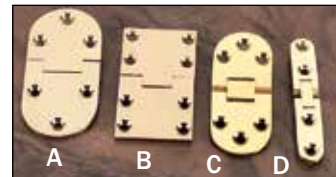

Butler's Tray and Table Hinges

Solid Brass Butler Tray Hinges lock in their flat position and hold vertical at 90° with a snap. Matte brass finish, screws not included.

L x W Open	Scrw. Size	Pair
130632 (A) 3" x $1\frac{1}{2}$ "	#6	\$16.79
130633 (B) $2\frac{1}{2}$ " x $1\frac{1}{2}$ "	#5	\$18.50

Solid Brass Table Hinges. Pair of solid brass hinges. Opens 180°, closes flush. Satin brass finish. Screws not included.

L x W Open	Scrw. Size	Pair
130634 (C) $2\frac{3}{4}$ " x $1\frac{3}{16}$ "	#6	\$12.50
130635 (D) $2\frac{3}{4}$ " x $1\frac{1}{2}$ "	#6	\$9.99



INNOVALA Pin Dampener

Innovative dampener technology puts an end to door slamming. This Pin Dampener is suitable for face frame and frame-less cabinets, is compatible with any self-closing hinge type, and mounts anywhere on the hinge side of cabinets. Single fastener, non-handed, easy installation with one included screw and childproof with no loose parts. One per package.

Each	6+
154123	\$3.99 \$3.59

Heavy-Duty Swivels

Designed for barstools, swivel chairs, television turntables and can be used as giant lazy susans. Heavy 12-gauge steel plates run smoothly on a full ball-bearing race. Mounting slots on corners (5 1/4" center-to-center) accept round head screws or bolts. Use the 3-degree swivel on chairs or stools designed with a slight backward tilt. The return swivel keeps barstool backs neatly aligned when not in use.



Overall size 7" x 7".	Swivel Style	Each
03M51	flat, 1" thick.....	\$12.99
03M52	3", 1 7/8" thick.....	\$14.99
03M53	return, 1 1/16" thick	\$22.99



Lazy Susan Bearings

Each durable smoothly lazy Susan unit glides smoothly on 1/4" ball bearings and maintains maximum stability, even under heavy loads. Use

them for revolving shelves in kitchen cabinets, planters, serving platters at the table, even large tabletops. 3" - 12" sizes are zinc-plated to guard against rust. The 17 5/16" unit is ideal for your largest revolving surfaces. It has a full 160 ball race captured in a durable ABS plastic housing for whisper-quiet operation and mar-free rubber feet to prevent slipping. 3" - 6" sizes are square, 9" - 17 5/16" are round.

Size	Capacity/ Pounds	Thickness	Each
02Z213"	200 ... 5/16"	\$2.25
02Z314"	300 ... 5/16"	\$3.25
02Z416"	500 ... 5/16"	\$3.99
1243009"	750 ... 5/16"	\$5.99
02Z5112"	1000... 5/16"	\$8.99
27A04	17 5/16"	220 ... 13/16"	\$64.99

Variable Overlay

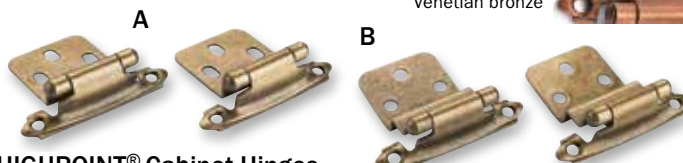
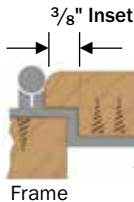
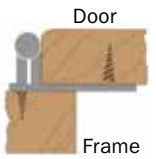

HIGHPOINT® Cabinet Hinges

HIGHPOINT® brand hardware is known for its finish and quality throughout the industry, and now HIGHPOINT® offers hinges to match in flush and 3/8" inset. Both hinges are surface mounted and easily installed. Whether you're replacing old hinges or seeking new, look no further than these HIGHPOINT® Hinges. The quality is in the detail - from design to manufacture finish. Sold in pairs, with screws.

(A) Variable Overlay	(B) 3/8" Inset
159670 antique brass.....	159676 antique brass.....
159671 nickel.....	159677 nickel.....
159672 polished brass.....	159678 polished brass.....
159673 satin chrome.....	159679 satin chrome.....
159674 oil rubbed bronze....	159680 oil rubbed bronze ...

COMPACT BLUMOTION Hinges

Since the 1980s Blum's COMPACT concealed hinge has proven itself as the high quality solution for face frame cabinets. The new **BLUMOTION soft closing mechanism** is integrated in the hinge cup and continues to provide the quality of motion you have come to expect from Blum hardware. The BLUMOTION function can be deactivated on one of the hinges, allowing small or light doors to close with the same high quality of motion. COMPACT BLUMOTION Hinges are interchangeable with current COMPACT Hinges. Sold in pairs with screws and instructions.

	Pair	6+
154177 3/8" overlay, edge mt.	\$11.99	\$10.79
154178 1/2" overlay, edge mt.	\$11.99	\$10.79
154179 3/4" overlay, edge mt.	\$11.99	\$10.79
154180 1 1/4" overlay, wraparound.....	\$11.99	\$10.79
154181 1 3/8" overlay, wraparound.....	\$11.99	\$10.79



Drawn Brass Cabinet Hinges

Custom designed cabinetry naturally deserves the finest solid brass hinges. Our brass hinges are individually machined to provide smooth operation. Mounting screws not included. Brushed Satin Finish. Hole patterns on Back Flap hinges vary by hinge size.

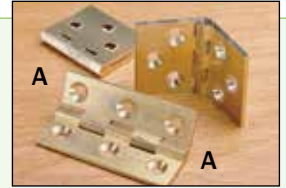

	Dimensions				Screw Size	Per Pair
	A	B	C	D		
(A) Box Hinges						
16Q11	1"	5/8"	1/4"	1/16"	#1	\$10.99
16Q21	1 1/2"	3/4"	5/16"	1/16"	#2	\$21.99
(A) Broad Cabinet Hinges						
16Q22	1 1/2"	7/8"	3/8"	5/64"	#4	\$21.99
16Q32	2"	1 1/8"	7/16"	3/32"	#4	\$22.99
16Q41	2 1/2"	1 3/8"	1/2"	3/32"	#6	\$23.99
(A) Full-Size Cabinet Hinges						
16Q42	2"	1 1/4"	1/2"	3/32"	#6	\$23.75
16Q51	2 1/2"	1 1/2"	5/8"	7/64"	#8	\$33.50
16Q52	3"	1 7/8"	3/4"	7/64"	#8	\$38.99
(B) Back Flap Hinges						
16Q61	1 1/2"	17/8"	13/16"	5/64"	#6	\$25.99
16Q62	1 1/2"	2 3/8"	1 1/16"	3/32"	#6	\$31.99
16R12	2"	3"	1 3/8"	1/8"	#8	\$41.50
(A) Polished Cabinet Hinges. Complete with screws						
Dimensions						
	A	B	C	D	Per Pair	
16R58	2"	2"	7/8"	3/32"	\$24.99	
16R59	2"	1 1/2"	5/8"	1/16"	\$22.99	

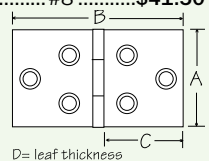

Custom Hardwood Dovetailed Drawers

Superior quality, solid hardwood, accurately and expertly machined custom dovetail drawers are only a "phone call" away. Constructed of 5/8" thick Lenga, that resembles American Cherry. Drawers are machined with 9/16", half blind dovetails that are one inch on center. Drawer bottoms are made from 1/4" Baltic Birch plywood and fit snugly into the grooved inside perimeter of the drawer. Reveal on the bottom of the drawer will accommodate the new under mount slides. Standard reveal is 1/2", but 1/4" or 3/8" reveals may be specified at time of order. Shipped knocked-down, ready-to-assemble. Just glue and clamp together. Drawer price is based on height and perimeter in inches.

Use the following formula to figure your price per drawer. Add the exterior drawer width and depth and then multiply by 2, giving you the linear inches of the perimeter of the drawer. Multiply this number by the linear inch cost that corresponds to the height of the drawer. Example: A drawer that is 4" H x 12" W x 22" D will cost \$44.20. **NOTE:** there is a minimum of 50 linear inches per drawer, prices are rounded up to the nearest inch. Ships in approximately 10 business days. For complete order information, please call our Customer Service Department: 800 535-4482.

Specifications:	Min.	Max.	Increment
Height	2"	12"	1/8"
Width	6"	46"	1/16"
Depth	6"	31"	1/16"

Linear Inch Cost	Price Per Drawer Height	Linear Inch
140715	2" - 2 7/8"	D/S \$0.60
140716	3" - 4 7/8"	D/S \$0.70
140717	5" - 6 7/8"	D/S \$0.80
140718	7" - 8 7/8"	D/S \$0.98
140719	9" - 10 7/8"	D/S \$1.10
140720	11" - 12 7/8"	D/S \$1.30

D/S = Item drop ships direct from manufacturer.

Pre-Cut Drawer Sides

Making drawers? Try using these pre-cut components to cut your project construction time and quite possibly save a few dollars as well. Our drawer sides are pre-finished and have a rounded top that provides a decorative edge. Both are 1/2" thick, slotted 1/4" for the drawer bottom and 60" in length.

Height	Length	Each	6+
159906	2 1/2"	60"	\$7.99 \$7.19
146705	4"	60"	\$12.50 \$11.25
146706	6"	60"	\$15.50 \$13.95
159905	8"	60"	\$19.99 \$17.99
147552	1/4" x 24" x 48"	prefinished drawer bottom (not shown).....	ea. \$17.50





BLUM
CLIP Top Inset Hinges
 Blum's newest CLIP Top Inset hinges make it possible to use inset doors on both face frame and frameless construction. New CLIP Top Hinge features single screw adjustment that positions door in and out for precise alignment. Use (A) for face frames and (B) for frameless applications. Sold in pairs with screws and instructions.
 Per Pair 6+

142856 (A)\$16.99....\$15.29
131236 (B).....\$18.50....\$16.65



BLUM 110° CLIP Top Hinges With BLUMOTION
 Silent and effortless—that's how doors close with CLIP Top BLUMOTION hinges. The new soft close mechanism is integrated in the hinge cup and continues to provide the quality of motion you have come to expect from Blum. CLIP Top BLUMOTION 110° hinges feature a new pivot point that allows the use on doors up to 1" thick. The BLUMOTION function can easily be deactivated on one of the hinges, giving small or light doors the same high quality of motion. CLIP Top BLUMOTION hinges work with all current CLIP mounting plates. You can upgrade your current hinges with no additional drilling, using the included hinge spacer. These hinges work on both face frame and frameless cabinets.

152739 110° face frame - 1/2" - 3/4" overlay full overlay, pair\$19.99
152740 110° full overlay, pair.....\$18.39
152741 110° face frame - 3/8" - 5/8" partial overlay, pair.....\$17.99
152742 110° partial overlay,..... pair\$17.99
152743 110° face frame inset,..... pair\$20.50
152744 110° inset, pair.....\$17.99

32mm Systems
 Intended for indexing cabinet components, this construction method is based on a grid of holes drilled on 32mm centers.



BLUM
Face Frame Hinges
 Produce the "European Look" with traditional face frame cabinets. Hinges open to 110°.

(A) Face Mount (shown) hinge mounts to the front of the face frame and has a minimum of 1 3/8" overlay.
 Per Pair 6+

02R80 face mount \$6.99..\$6.29
Edge Mount style hinge mounts to the inside edge of the face frame with 1/2" or 3/4" of overlay.
02R85 1/2" overlay..\$6.99..\$6.29
02R90 3/4" overlay..\$6.99..\$6.29
142511 35mm carbide bit \$28.99



BLUM
CLIP Top Hinges With Cam Plate Technology And Spiral Tech Adjustment
 Removable hinge technology combined with single screw plate and hinge adjustment make these the most advanced hinges on the market today. Now with the turn of a fixed screw you can move the Cam Action Hinge Plate up and down for precise door adjustment in the carcass. Also, with the door attached to the hinge plate, through "Spiral-Tech" depth adjustment you can move the door in or out of the carcass for perfect alignment.
 Per Pair 6+

142852 120° full \$11.99 \$10.79
142853 120° half \$10.99...\$9.89
142854 170° full..\$16.99 \$15.30
142855 170° half \$18.99 \$17.09
142511 35mm carbide bit \$28.99

BLUMOTION For Doors
 Get a smooth, silent close with the Blumotion system. It creates a perfect closing motion as it reacts automatically to door size, door weight and closing speed, then brakes the motion of the door accordingly.



Blumotion For Compact Hinges was developed especially for use with Blum Compact Hinges but can be used with any style of European self-closing hinge. Mounts directly to the cabinet. Mounting hardware and instruction included.
 Each 6+

147965\$4.99....\$4.49



Blumotion Snap-On Style was developed to attach directly to specific Blum hinges of current manufacture in certain applications (see *Woodcraft hinge application below*). They snap directly onto the back of the hinge. No drill, no screws and no holes in your cabinets, only perfect closings. Mounting instruction included.

For Woodcraft hinges 131236 and 142852
 Each 6+
147966 T5550\$4.19.....\$3.77

For Woodcraft hinges 142853 and 142856
 Each 6+
147967 71T5650...\$5.79.....\$5.21

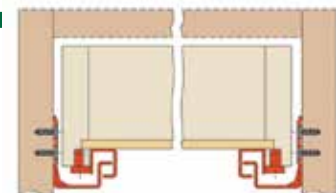

SALICE Futura Undermount Drawer Slides
 Salice is a leader in making undermount slides like these Futura concealed undermount runners that are suitable for all drawer opening applications. The full extension Push-To-Open Slide features a push opening system for handle-free drawers. Only a slight pressure on the drawer front is sufficient for the drawer to self-open. The Soft-Close Slide features the Smove System that is fully integrated into the runner, allowing a decelerating closing action. The six-way adjustable mounting clip makes for an easy, no-fuss installation. Slides are sold in pairs with instructions, screws, front fixing clips and rear mounting brackets.
 160780 - 160782
 Slides only, drawers not included

160783 - 160785



160780 soft close 15"\$37.99
160781 soft close 18"\$38.99
160782 soft close 21"\$39.99
160783 push-to-open 15"\$37.99
160784 push-to-open 18" ...\$38.99
160785 push-to-open 21" ...\$39.99
160786 drilling tmpit.ea. \$39.99

BLUM
Compact Face Frame Hinges
 The Compact 38N is the highest quality face frame hinge for small overlays. Its integrated cam depth adjustment, along with its proven side and height adjustment, enable a quick and simple 3-dimensional door adjustment. All hinges are equipped with a self-closing mechanism which guarantees that the door will close securely. We offer both a Wrap Mount and an Edge Mount design.
 Per Pair



146560 1/2" overlay wrap\$6.29
146561 3/4" overlay wrap\$6.29
146562 1/2" overlay edge\$6.29



WoodRiver® Forstner Bit, Carbide Tipped, 35mm
 This 35mm carbide tipped bit is part of a line of imported Forstner bits that Woodcraft has tested and found to cut clean and not burn even when subjected to quick, repetitive drill press borings. An exceptional value for the hobbyist or occasional user. 3/8" shank.
142511\$28.99



BLUM
CLIP Top 60° Bi-fold Hinge
 Designed specifically for doors that meet at an inside corner, this hinge swings open approximately 60°, clearing the adjacent cabinet frame, and then opens completely to give access to the inside of the cabinets. Must be used with 170° hinge (frame-less or face frame) on adjacent door. Sold in pairs with screws and instructions.
 Per Pair 6+

152955\$23.99....\$21.59

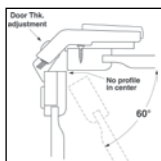

Face Frame Hinge 170° Opening. Specially designed for use in Bi-Fold applications or where maximum door swing is needed. Overlay of 1/2" to 3/4" is achieved by varying the boring distance. Sold in pairs with screws and instructions.
 Per Pair 6+

131054\$16.29...\$14.66



DrillRite
35mm Hinge Jig And Bit
 The new DrillRite Jigs are designed for the small shop and occasional cabinetmaker. 35mm Hinge Jig is a plastic template for marking the hinge cup and screw positions for 35mm European style hinges, or 6 handle widths from 2 1/2" to 4". Includes a 35mm forstner bit.
143958\$11.50



HIGHPOINT® DRAWER SLIDES HIGHPOINT® Slides represent the highest quality in all metal, ball bearing drawer slides. These smooth, quiet full extension slides install simply using either the 32mm system, or rear mounting brackets for face frame applications. All slides are packaged with mounting instructions and screws.



HIGHPOINT® DC3600

Full Extension Side Mount Drawer Slide

Side-mount ball bearing slide in all bright chrome finish slide. Disconnects with lever release. Rated at 75 lbs. Sold in pairs.

	Pair	5+	10+		Pair	5+	10+
160609 12"...	\$15.99	\$13.59	\$11.99	160614 22"...	\$20.50	\$17.43	\$15.38
160610 14"...	\$16.79	\$14.27	\$12.59	160615 24"...	\$21.50	\$18.28	\$16.13
160611 16"...	\$17.99	\$15.29	\$13.49	160616 26"...	\$21.99	\$18.69	\$16.49
160612 18"...	\$18.50	\$15.73	\$13.88	160617 rear brkt.			
160613 20"...	\$18.99	\$16.14	\$14.24		\$3.99	\$3.39	\$2.99



HIGHPOINT® DC3010SC

Soft-Close Full Extension Side Mount Drawer Slide

Heavy-duty, side-mount ball bearing slide, all bright chrome finish slide with soft-closing AIR CUSHION. Disconnects with a lever release. Rated at 100 lbs. Sold in pairs.

	Pair	5+	10+
160618 16".....	\$18.50	\$15.73	\$13.88
160619 18".....	\$18.99	\$16.14	\$14.24
160620 20".....	\$19.50	\$16.58	\$14.63
160621 22".....	\$19.99	\$16.99	\$14.99
160622 rear brcket.....	\$3.99	\$3.39	\$2.99

HIGHPOINT® 3J01 Full Extension Side Mount Drawer Slide

Most reliable and safest to use, this slide can be used for general residential furniture, system furniture, office furniture, kitchen cabinets or medical drawers. This clear zinc, heavy-duty slide is the smoothest slide we have used, disconnects with a lever release. Rated at 75 lbs. Sold in pairs.

	Pair	5+	10+		Pair	5+	10+
160230 10"...	\$12.50	\$10.63	\$9.38	160235 20"...	\$14.99	\$12.74	\$11.24
160231 12"...	\$12.99	\$11.04	\$9.74	160236 22"...	\$15.99	\$13.59	\$11.99
160232 14"...	\$13.50	\$11.48	\$10.13	160237 24"...	\$16.50	\$14.03	\$12.38
160233 16"...	\$13.99	\$11.89	\$10.49	160238 rear bracket			
160234 18"...	\$14.50	\$12.33	\$10.88		\$3.99	\$3.39	\$2.99

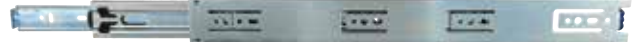

HIGHPOINT® 3M01 Full Extension Side Mount Drawer Slide

This clear zinc 3M01 slide features 12.7mm (.5") side spacing, perfect for any kitchen upgrade project or the most demanding uses having passed the ANSI/BIFMA 50,000 cycle test. Disconnects with lever release. Rated at 100 lbs.

	Pair	5+	10+		Pair	5+	10+
160239 10"...	\$15.99	\$13.59	\$11.99	160244 20"...	\$18.50	\$15.73	\$13.88
160240 12"...	\$16.50	\$14.03	\$12.38	160245 22"...	\$18.99	\$16.14	\$14.24
160241 14"...	\$16.99	\$14.44	\$12.74	160246 24"...	\$19.50	\$16.58	\$14.63
160242 16"...	\$17.50	\$14.88	\$13.13	160247 rear bracket			
160243 18"...	\$17.99	\$15.29	\$13.49		\$3.99	\$3.39	\$2.99

A 159131, 159133



Salice 105° Silentia

Soft-Close Hinge, Titanium Finish

This Salice Silentia hinge has soft-close function integrated into the cup, hidden from view, so no additional components are needed. Sold in pairs with screws and instructions.

Face Frame Cabinets (A)	Pair	6+	10+
159131 1/2" overlay....	\$14.99	\$13.49	\$12.74
159132 3/4" overlay ..	\$14.99	\$13.49	\$12.74
159653 inset	\$16.99	\$15.29	\$14.44

Frameless Cabinets (B)	Pair	6+	10+
159135 11/16" overlay	\$14.99	\$13.49	\$12.74
159136 3/8" overlay....	\$14.99	\$13.49	\$12.74

Salice 110° Self-Close Hinge, Titanium Finish

Versatile concealed hinge systems with height, depth and side adjustments are available in both face frame and frameless applications. 12mm depth and 35mm cup. Sold in pairs with screws and instructions.

Face Frame Cabinets (A)	Pair	6+	10+
159133 1/2" overlay....	\$11.99	\$10.79	\$10.19
159134 3/4" overlay ..	\$11.99	\$10.79	\$10.19
159654 inset	\$11.99	\$10.79	\$10.19

Frameless Cabinets (B)	Pair	6+	10+
159137 11/16" overlay....	\$9.99	\$8.99	\$8.49
159138 3/8" overlay.....	\$9.99	\$8.99	\$8.49

Salice 106° Excen-Three Self-Close Face Frame Hinge

Enjoy simple installation and precise door alignment with this low-profile, one-piece concealed cup hinge. Three eccentric cams allow you to easily adjust the doors (side to side, up and down, and in and out). Twin-screw attachment to the cabinet frame provides superior stability, and a low hinge profile allows pullout shelves to extend without interference. Made of solid steel, corrosion-resistant nickel or titanium finish and available for several levels of door overlay. Opens to 106°. Sold in pairs with screws and instructions.

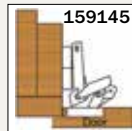
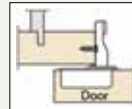
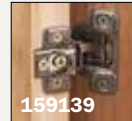

Titanium Finish	Pair	6+	10+
159139 1/2" overlay	\$7.99	\$7.19	\$6.79
159140 1 1/4" overlay.....	\$7.99	\$7.19	\$6.79

Nickel Finish	Pair	6+	10+
159141 1/2" overlay.....	\$6.99	\$6.29	\$5.94
159142 5/8" overlay.....	\$6.99	\$6.29	\$5.94
159143 3/4" overlay.....	\$6.99	\$6.29	\$5.94
159144 1 1/4" overlay....	\$6.99	\$6.29	\$5.94

Salice 110° Door 3/8" Lipped Face Frame Hinge

Especially developed to fit 3/8" Lipped Doors. Made of solid steel and featuring a beautiful nickel finish, this concealed hinge opens to 110°. For face frame applications only, and is ideal for retrofitting older cabinetry. A 5/8" mounting plate clearance is required on the face frame's back edge. 9mm depth and 35mm cup. Sold in pairs with screws and instructions.



Nickel Finish	Pair	6+	10+
159145	\$29.99	\$26.99	\$25.49
159655 SMOVE...each	\$5.99		

HÄFELE

HÄFELE Face Frame Euro Hinges

Häfele A-Series Face Frame hinges are the best value on the market. Affordable quality means competitively priced, without losing any quality. These hinges are Grade 2 and LGA approved, with over 80,000 cycle tests.

	Per Pair	6+
152958 1/2" Overlay	\$2.99	\$2.69
152957 5/8" Overlay	\$3.75	\$3.37
152956 1 1/4" Overlay	\$5.49	\$4.94

HÄFELE A-Series Clip Hinges

This European style "clip" hinge incorporates a three-way adjustment allowing fast and precise corrections of assembly or installation inaccuracies. Adjustments are integrated into the hinge and baseplate.

Faceless Cabinets	Per Pair	6+
152962 full overlay	\$5.49	\$4.94

	Per Pair	6+
152961 half overlay	\$5.99	\$5.39
152960 inset	\$5.49	\$4.94
152959 165° full overlay.....	\$14.99	\$13.49

Face Frame Cabinets	Per Pair	6+
152964 3/4" overlay	\$6.50	\$5.85
152963 1/2" overlay	\$4.99	\$4.49

Overlay Door: The door overlays/overlaps the cabinet frame or carcass. A full overlay covers the carcass on a frameless cabinet. Partial overlay will only cover part of the carcass.

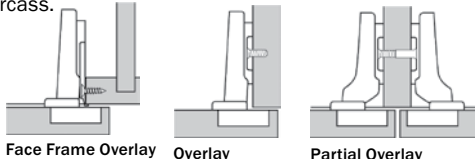

Inset Door: The frame, or carcass is visible when the cabinet door is closed. The door edge is concealed and extends into the frame, or carcass cavity.

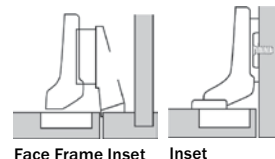



Knap & Vogt Drawer Slides

Knap & Vogt Drawer Slides reflect years of research and customer input. KV has built the smoothest action, quietest, strongest precision slide in the hardware industry to become the premier industry leader. Slides are all metal with pre-lubricated ball bearings and come packaged with mounting instructions and screws.

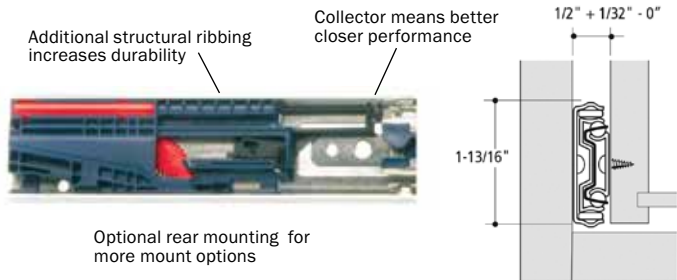

KV 8450FM

Soft-Close Full-Extension Drawer Slides

The new KV8450FM Series is a step forward in side-mounted ball-bearing drawer slides. The KV 8450FM series incorporates state-of-the-art, "best of class" soft-close technology. Fully integrated soft close module brings a drawer box to a smooth, quiet and secure closure. Soft-close module is fully integrated into the KV 8450-style slide with same side clearance as standard slides, allowing cabinetmakers to migrate directly to KV 8450FM series products with no setup changes. All bright chrome finish. Sold in pairs.

	Pair	5+	10+
16059216".....	\$25.50	\$21.68	\$19.13
16059318".....	\$25.99	\$22.09	\$19.49
16059420".....	\$26.50	\$22.53	\$19.88
16059522".....	\$26.99	\$22.94	\$20.24
160596 rear bracket.....	\$4.99	\$4.24	\$3.74

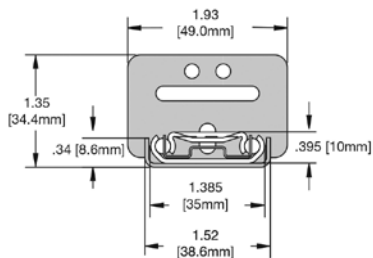

KV 1129 Center Mount Drawer Slide

Great for upgrading kitchens, bathrooms, or bureaus, these slides mount under the drawer and include a rear mounting bracket and nylon friction pads for use between the drawer and face frame. Rated at 35 lbs., the slides have a bright chrome finish, a friction disconnect, and can be used individually or in pairs on wider drawers. Sold individually.

	Each	5+	10+
16058316".....	\$10.50	\$8.93	\$7.88
16058418".....	\$10.99	\$9.34	\$8.24
16058520".....	\$11.50	\$9.78	\$8.63
16058622".....	\$11.99	\$10.19	\$8.99



KV 1805 3/4 Extension White Epoxy Coated, Self-Close Euro Drawer Slides

These heavy gauge steel drawer slides have a load rating of 75 lbs. and mount easily to the drawer bottom. Slides have 32mm mounting hole pattern. Self-closing feature keeps kitchens looking neat, and slides have silent nylon bearings and durable white epoxy finish. 3/4 extension. Sold in pairs.

	Pair	5+	10+
16058717".....	\$8.50	\$7.23	\$6.38
16058819".....	\$8.99	\$7.64	\$6.74
16058921".....	\$9.50	\$8.08	\$7.13
16059023".....	\$9.99	\$8.49	\$7.49
160591 rear bracket.....	\$5.99	\$5.09	\$4.49

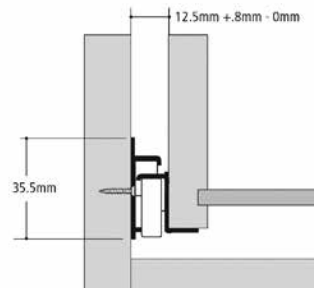

KV TT100

Full-Extension Drawer Slides

Designed for use in 32mm cabinet systems, these TT100 slides have some great features. The first mounting hole is located for the 37mm set-back used in the European system, and the load rating has been increased to 100 lbs. The narrow 1/2" side clearance and the low 1 3/4" height are great for shallow drawers. Slides move on silent-rolling ball bearings and feature hold-in and out stops, and a quick disconnect lever. Sold in pairs.



	Pair	5+	10+
16059716".....	\$17.50	\$14.88	\$13.13
16059818".....	\$17.99	\$15.29	\$13.49
16059920".....	\$18.50	\$15.73	\$13.88
16060022".....	\$18.99	\$16.14	\$14.24
16060124".....	\$19.50	\$16.58	\$14.63
160602 rear bracket.....	\$4.99	\$4.24	\$3.74



KV 1260

3/4 Extension Drawer Slides

These medium duty 3/4-extension slides are designed for cabinets, desks and fixtures. They have a 60-lb. load rating and feature smooth ball bearing rollers that run effortlessly on the rust-resistant cold rolled steel slides. Assembly instructions and screws included. Sold in pairs.

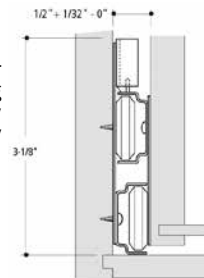

	Pair	5+	10+
16060316".....	\$10.99	\$9.34	\$8.24
16060418".....	\$11.50	\$9.78	\$8.63
16060520".....	\$11.99	\$10.19	\$8.99
16060622".....	\$12.50	\$10.63	\$9.38
160607 rear bracket.....	\$5.99	\$5.09	\$4.49



KV 1175 Tri-Roller

Center Mount 3/4 Bottom Extension 22 5/8" Drawer Slide

Designed for general light-duty drawer applications under 50 lbs., this slide feature action rollers and allows the drawer to lift out for easy removal. Sold individually.

	Each	5+	10+
160608.....	\$9.99	\$8.49	\$7.49



HÄFELE Non-Mortised Decorative Hinge With Finial

Update your kitchen or add a touch of class to your next cabinet project. Häfele offers a comprehensive portfolio of functional and fashionable themes that let you express the contemporary, traditional or transitional style you have in mind. The ultimate in professional cabinetry hardware, these Häfele hinges are as strong as they are beautiful. Features silent, reliable performance, horizontal and vertical adjustments. This full inset, partial wrap hinge has a minaret finial/tip. It accommodates a 3/4" thick door with a door gap as small as 1/16". Partial wrap hinges are best used on frameless cabinets. Sold individually, with screws.

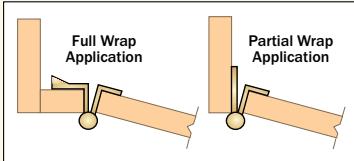

Full Wrap	Partial Wrap	Finish/Finial	Each	5+
159840	159852	Antique Brass – Minaret	\$3.99	\$3.59
159842	-	Antique Brass – Ball	\$3.99	\$3.59
159846	159859	Black – Minaret	\$3.99	\$3.59
159847	159860	Black – Ball	\$3.99	\$3.59
159850	159863	Brass Plated – Minaret	\$3.99	\$3.59
159851	159864	Brass Plated – Ball	\$3.99	\$3.59
159844	159856	Copper Bronze – Minaret	\$3.99	\$3.59
159845	159857	Copper Bronze – Ball	\$3.99	\$3.59
160713	159858	Chrome Plated – Minaret	\$3.99	\$3.59
160714	160719	Chrome Plated – Ball	\$3.99	\$3.59
159848	159861	Matte Nickel – Minaret	\$3.99	\$3.59
159849	159862	Matte Nickel – Ball	\$3.99	\$3.59
159841	159853	Oil Rubbed Bronze – Minaret	\$3.99	\$3.59
159843	159855	Oil Rubbed Bronze – Ball	\$3.99	\$3.59
160717	160722	Pewter – Minaret	\$3.99	\$3.59
160718	160723	Pewter – Ball	\$3.99	\$3.59
160715	160720	Satin Chrome – Minaret	\$3.99	\$3.59
160716	160721	Satin Chrome – Ball	\$3.99	\$3.59



SUGATSUNE Adjustable Soft Down Lid Stay

Model SDS-C301N

This stay is an excellent choice for an upward and top opening flap door with concealed or single knuckle hinges. It is designed to securely latch a flap closed and hold the flap in a fully opened position with a soft close. Stay is non-handed and available in black or white.

160108	black	\$19.99
160109	white	\$19.99



SUGATSUNE Adjustable Soft Down Lid Stay Model NSDX-35

This lid stay is an excellent choice for an upward-opening flap door with piano, butt or concealed hinges. Opening angle can be 80°, 90° or 100°. The NSDX-35 is designed to hold a door in fully opened position. Speed adjustment screw is located on front for easy adjustment. Includes face frame bracket.

160105	right	\$25.99
160107	left	\$25.99

HÄFELE Non-Mortised Decorative Butt Hinge With Finial

Quick and easy mounting. These non-mortised hinges are work on a myriad of projects. A great value with a wide selection of finishes. Solid Steel. 3/16" tip to tip. Two-way adjustment. Sold in pairs with mounting screws.



Antique Brass Shown

Finish	Each	5+
159865	Antique Brass	\$4.99 / \$4.49
159867	Black Matte	\$4.99 / \$4.49
159868	Brass Plated	\$4.99 / \$4.49
160705	Chrome Plated	\$4.99 / \$4.49
159866	Oil Rubbed Bronze	\$4.99 / \$4.49
159869	Matte Nickel	\$4.99 / \$4.49
160706	Pewter	\$4.99 / \$4.49
160707	Satin Chrome	\$4.99 / \$4.49

HÄFELE Mortised Decorative Solid Brass Butt Hinge with Finial

Quality Solid Brass Hinges from Häfele add a solid touch of class to any cabinet or large box project. Typically used in inset face frame applications, but really have a multiple uses. Hinge is 2 3/4" tip to tip. Leaves are 3/4" x 2" and a solid 1/16" thick. Sold as single with mounting screws.

Satin Chrome Shown



Finish	Each	5+
159833	Antique Brass	\$11.99 / \$10.79
159836	Black Matte	\$11.99 / \$10.79
159794	Brushed Nickel	\$11.99 / \$10.79
159832	Polished Brass	\$11.99 / \$10.79
159835	Oil Rubbed Bronze	\$11.99 / \$10.79
160702	Polished Chrome	\$11.99 / \$10.79
160704	Satin Chrome	\$11.99 / \$10.79
160703	Pewter	\$11.99 / \$10.79

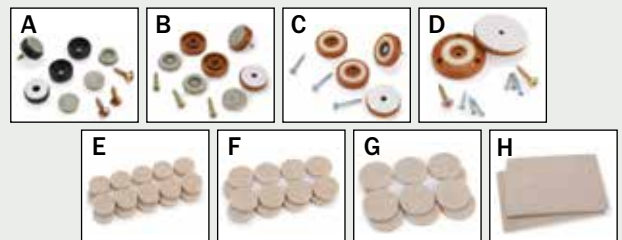

Slipstick® Foot Floor Protectors

The Slipstick Foot floor protector is a unique floor protection device that is attached to the legs or base of most furniture. The Foot is easily attached via "peel and stick" super bonding adhesive or screw on. The Slipstick Feet series of floor protectors is available as "slider" or "gripper" floor protectors. The slider glides easily without scratching, and the gripper provides ultimate floor protection along with nonslip grip. Slipstick also provides Ultra Heavy-Duty Self-Adhesive Felt Pads in assorted sizes. They have a super bonding adhesive backing and can be used on wood, metal, tile, glass and more.

153393	(A) 3/4" Slider Foot, 16-pc., black	\$9.99
153396	(B) 1" Slider Foot, 8-pc, caramel	\$8.99
153397	(C) 1 1/4" Gripper Foot, caramel, 8-pc.	\$8.99
153394	(D) 2" Gripper Foot, 4-pc., caramel	\$7.99
153399	(E) 3/4" Round Self-Stick Felt Pads, 20-pc.	\$4.50
153400	(F) 1" Round Self-Stick Felt Pads, 16-pc.	\$4.50
153401	(G) 1 1/2" Round Self-Stick Felt Pads, 12-pc.	\$4.50
153402	(H) 4 1/2" x 6" Self-Stick Felt Pads, 2-pc.	\$5.99

Fasteners

HIGHPOINT® Extra Torque (XT)

means just that! Commonly available screws will actually break around 25-30 inch/lbs., fine for light duty applications, but woodworking demands something better. HIGHPOINT® Extra Torque Woodworking Screws are engineered for tough applications with almost twice the torque values of other screws!

ADVANTAGES OF A SQUARE DRIVE DESIGN:

Bits are less likely to jump out of the recess and allowing more driving torque.

Square Drive offers a positive "stick-fit" which stays on the screwdriver bit tip; handy for starting screws overhead or from other difficult angles.

Bits will last longer and are less likely to damage the screw.



Dry Lube 100 Pack

Size	1-4 Packs	5+
#6 x 1/2"	610100 \$3.99	\$3.59
#6 x 3/4"	610101 \$3.99	\$3.59
#6 x 1 1/4"	610102 \$3.99	\$3.59
#8 x 3/4"	610103 \$3.89	\$3.50
#8 x 1"	610104 \$4.59	\$4.13
#8 x 1 1/4"	610105 \$4.69	\$4.22
#8 x 1 1/2"	610106 \$5.29	\$4.76
#8 x 1 3/4"	610107 \$5.39	\$4.85
#8 x 2"	610108 \$5.99	\$5.39
#8 x 2 1/4"	610109 \$7.39	\$6.65
#8 x 2 1/2"	610110 \$7.79	\$7.01
#8 x 3"	610111 \$9.99	\$8.99
#10 x 1 1/2"	610206 \$5.99	\$5.39
#10 x 2"	610208 \$7.50	\$6.75
#10 x 2 1/2"	610210 \$8.99	\$8.09
#10 x 3"	610211 \$10.50	\$9.45

Black Oxide 100 Pack

Size	1-4 Packs	5+
613100	\$3.09	\$2.78
613101	\$3.69	\$3.32
613102	\$5.50	\$4.95
613103	\$4.29	\$3.86
613104	\$4.99	\$4.49
613105	\$5.25	\$4.73
613106	\$6.49	\$5.84
613107	\$7.75	\$6.98
613108	\$6.99	\$6.29
613109	\$8.29	\$7.46
613110	\$8.79	\$7.91
613111	\$13.99	\$12.59

Clear Zinc 100 Pack

Size	1-4 Packs	5+
611200	\$5.50	\$4.95
611201	\$4.39	\$3.95
611202	\$4.59	\$4.13
611203	\$4.49	\$4.04
611204	\$7.99	\$7.19
611205	\$5.29	\$4.76
611206	\$6.89	\$6.20
611207	\$8.89	\$8.00
611208	\$10.50	\$9.45
611209	\$10.50	\$9.45
611210	\$10.99	\$9.89
611211	\$15.50	\$13.95

Yellow Zinc 100 Pack

Size	1-4 Packs	5+
612100	\$3.59	\$3.23
612101	\$3.99	\$3.59
612102	\$5.99	\$5.39
612103	\$4.99	\$4.49
612104	\$5.19	\$4.67
612105	\$5.29	\$4.76
612106	\$6.69	\$6.02
612107	\$6.89	\$6.20
612108	\$7.39	\$6.65
612109	\$8.49	\$7.64
612110	\$9.50	\$8.55
612111	\$11.89	\$10.70



BLACK OXIDE finish is a decorative coating that will provide a clean finished appearance, even in visible areas of assembly.

CLEAR ZINC plating is primarily a decorative finish commonly found on most general hardware. It provides a moderate amount of corrosion resistance but is recommended for interior applications.

YELLOW ZINC plating gives these screws a golden color that resembles brass and provides a moderate amount of corrosion resistance.

HIGHPOINT® Cabinetry Screws offer solutions to all of your Cabinetry needs. We now have a complete line of Cabinet hanging, drawer front and drawer slide mounting screws. Woodcraft now offers top quality HIGHPOINT® Driver Bits and Bit holders. View our entire selection online or visit one of our retail locations.



HIGHPOINT® Cabinet Hanging Screws

These hanging screws are manufactured with a heavy duty #10 body and a large diameter washer head to prevent the fastener from pulling through the cabinet back. #2 Square Combo Drive. Packs of 100

Size	Zinc Plated	White Painted Head
#10 x 2 1/2"	618100 \$16.99	618104 \$19.49
#10 x 3"	618101 \$18.99	618105 \$25.99

HIGHPOINT® Gimlet Set, 4-piece

HIGHPOINT® Gimlets are the perfect tools to start holes for those pesky small screws. Set includes 2mm, 3mm, 4mm and 4.5mm. Perfect for screw sizes #2 through #8.

159695 \$4.99

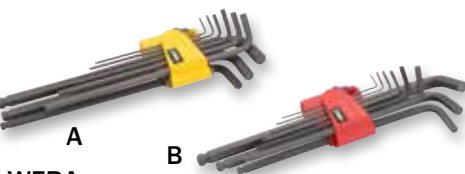

WERA 9 Piece Hex Keys, Imperial And Metric

Wera's Hex Plus design provides more surface contact and reduces the rounding of the hex recess while transferring up to 20% more torque. Their ample length and ball end design allows driving off-axis in challenging applications and feature large,

Drawer Front Adjusting Screws

Drawer front screws have an oversized 1/2" diameter round washer head for easy drawer front adjustment. Simply drill an oversized hole (5/16" to 3/8") through the drawer box and attach the front. Loosen the screws to allow for perfect alignment, and tighten to finish the job. You'll also find these oversized round washer head screws useful for attaching tabletops, jig construction and mounting various brackets and hardware. #2 Phillips Drive, Zinc Plated Steel. Sold in packs of 100.

Size	1-4 Packs	5+
#8 x 7/8"	617100.....\$6.99	\$6.29
#8 x 1"	617101.....\$6.99	\$6.29
#8 x 1 1/8"	617102.....\$8.50	\$7.65
#8 x 1 1/4"	617103.....\$8.69	\$7.82

WERA Professional Screwdrivers

Upgrade your hand-tool "basics" - screwdrivers - with these professional grade tools. Their revolutionary hardened steel Lasertip® actually grips the screw recess when engaged, reducing the chance of the tip slipping from the fastener. Ergonomically designed Kraftform® handles have hard and soft zones that provide optimal torque with less user fatigue.

150470 Wera Screwdriver Set, 6-pc. w/rack.....
Super Saver Set!.....\$38.50

easy to read, durable, laser engraved markings of the nine sizes. A fold over clip keeps keys secure and organized for your next important project.

151254 (A)\$16.50
151255 (B) metric key set.....\$16.50

HIGHPOINT® Slide Mounting Screws

Flatheads: Nickel finish matches European hinges and drawer slides.

Undercut Screws: Concentric round heads fit flush in European hinges and slides. Auger points reduce splitting.

Low Profile Ball Bearing Slide Screws: The low profile head to clears drawer members, eliminating the "clicking" sound that often comes when using standard pan head screws.

#2 Phillips Packs of 100

Flathead, Nickel
614006 #6 x 5/8".... \$4.29

Undercut Flathead, Zinc
615100 #6 x 7/16".... \$3.99
615101 #6 x 1/2" \$3.99
615102 #6 x 5/8".... \$3.99
615103 #6 x 3/4" \$4.99

Low Profile For Ball Bearing Slides, Zinc
616110 #8 x 7/16" .. \$5.09
616111 #8 x 1/2"..... \$5.09

GRACE USA Brass Starter Punch Set

Non-marring and precision-machined to fit common pin sizes, this punch set is great for driving pins or fitting parts when marking or scratching the surface can mean the difference between a job well done and disaster. The Starter Punch Set includes four flathead, tapered punches - machined from premium, brass hex - for driving pins flush. Punch sizes are: 1/16", 3/32", 1/8", and 5/32" diameter. Set comes with plastic storage pouch for easy access. Made in the USA.

158879 4-piece set\$19.99

HIGHPOINT® XT®

Round Washer Head Screws

Round Washer head screws have a raised pan head with an integral washer formed during the heading process to prevent the screw from being over-driven, making them perfect for fastening almost any type of mounting bracket. Deep thread design holds well in both hard and soft woods and the Extra Torque (XT) hardened steel screws are suitable for demanding applications. Black Oxide plating offers moderate corrosion resistance. Unlike pocket hole screw, these screws have a standard thread length (1" and under- full thread; over 1" - 2/3 thread). #2 Square Drive. 100 per package.

Size	1-4 Packs	5+	Size	1-4 Packs	5+		
#8 x 5/8"	630102	\$4.89	\$4.40	#8 x 2 1/4"	630109	\$8.29	\$7.46
#8 x 3/4"	630103	\$5.29	\$4.76	#8 x 2 1/2"	630110	\$7.79	\$7.01
#8 x 1"	630104	\$5.59	\$5.03	#8 x 3"	630111	\$8.50	\$7.65
#8 x 1 1/4"	630105	\$5.79	\$5.21	#10 x 3/4"	630203	\$5.99	\$5.39
#8 x 1 1/2"	630106	\$6.39	\$5.75	#10 x 1"	630204	\$6.79	\$6.11
#8 x 1 3/4"	630107	\$6.99	\$6.29	#10 x 1 1/4"	630205	\$6.89	\$6.20
#8 x 2"	630108	\$7.29	\$6.56	#10 x 2"	630208	\$9.50	\$8.55
				#10 x 2 1/2"	630210	\$11.49	\$10.34



Patented Double Auger Thread

HIGHPOINT®

General Purpose Screws

Zinc plated fasteners have our patented double auger thread design, our black oxide and #6 screws have a single auger thread. All have a Type 17 self-drilling point that reduces splitting, reduces driving torque and allows these screws to be driven into most hardwoods, plywood and particle board without the need for pre-drilling. Countersinking Nibs under the head remove material for a clean finish. Combination Drive recess may be driven with #2 square or Phillips bit.

Size	Zinc Finish		Black Oxide Finish			
	1-4 Packs	5+	1-4 Packs	5+		
#6 x 1/2"	606101	\$3.50	\$3.15	609100	\$3.99	\$3.59
#6 x 3/4"	606102	\$3.50	\$3.15	609101	\$3.99	\$3.59
#8 x 1"	607501	\$4.59	\$4.13	609103	\$3.99	\$3.59
#8 x 1 1/4"	607502	\$4.69	\$4.22	609104	\$5.09	\$4.58
#8 x 1 1/2"	607503	\$5.50	\$4.95	609105	\$5.19	\$4.67
#8 x 1 5/8"	607504	\$5.99	\$5.39	609106	\$5.99	\$5.39
#8 x 1 3/4"	607505	\$6.99	\$6.25	609107	\$5.99	\$5.39
#8 x 2"	607506	\$6.99	\$6.29	609108	\$6.50	\$5.85
#8 x 2 1/4"	607507	\$7.99	\$7.19	609109	\$8.99	\$8.09
#8 x 2 1/2"	607508	\$8.99	\$8.09	#9 609110	\$7.50	\$6.75
#8 x 3"	607509	\$10.50	\$9.45	#9 609111	\$10.39	\$9.35

HIGHPOINT® Confirmat Style Connecting Screws

Confirmat style connecting screws are designed for cabinets or other types of box construction using melamine, particle board, and MDF. These unique fasteners form a strong, stiff butt joint because of the large shoulder under the head that locks the screw into the wood and prevents pulling through in softer materials.

You will notice that these thick fasteners have a blunt point. To install, simply align the two pieces and drill a pilot hole with a specially designed three step bit. A slight unthreaded portion at the tip makes it easy to line up the holes during assembly. Connecting screws can be reinstalled several times without loss of holding power.

Offered in two sizes: 5mm x 40mm (1 1/2" nominal length) for use with 1/2" thick materials, 7mm x 50mm (2" nominal length) for use with 3/4" thick materials. Use #2 PozDrive bit for 5mm x 40mm, #3 PozDrive bit for 7mm x 50mm. Both are bright



zinc plated for a clean, finished look. Starter Kit includes: Step drill bit, repl. pilot, PozDrive bit and 100-screw box.

614000 (A) 5 x 40 mm, 100 ..	\$7.99
5+ boxes	\$7.19
149260 5 x 40 mm Starter Kit	\$39.50
614001 7 x 50 mm, 100	\$9.39
5+ boxes	\$8.45
149261 7 x 50 mm Starter Kit	\$43.39
148114 PozDrive Bits (3)	
(B) #2" x 2 3/4" @	\$7.69
148115 PozDrive Bits (3)	
#3 x 2 3/4" @	\$7.39
148090 (C) Snappy Step Drill	
5 x 40 mm	\$21.39
148091 Replacement Pilot	
5 x 40 mm	\$6.50
148092 (C) Snappy Step Drill	
7 x 50 mm	\$23.50
148093 Repl. Pilot for 7 x 50 mm ...	\$8.39
614008 5mm white caps, 100	\$3.29
614009 7mm white caps, 100	\$3.99



IRWIN® Impact Performance Series™ fastener drive bits are engineered for maximum durability and long life with impact drivers. Insert and power bits are designed with precision tip geometry so they fit fasteners more precisely, which reduces stripping and cam-out. Insert bits fit standard C-ring design bit holders and Power Bits fit quick-change driver adapters.

Insert Bits

#2 Phillips, 1"	161128 2-pc.	\$2.50	#2 Square, 1"	161131 2-pc.	\$2.50
#3 Phillips, 1"	161129 2-pc.	\$1.99	#3 Square, 1"	161132 2-pc.	\$1.99
#1 Square, 1"	161130 2-pc.	\$1.99			

Power Bits Phillips

#1 Phillips, 2"	161134 2-pc.	\$2.99			
#1 Phillips, 4"	161135 1-pc.	\$3.49			
#1 Phillips, 6"	161136 1-pc.	\$4.99	#1 Square, 2"	161143 2-pc.	\$3.75
#2 Phillips, 2"	161137 2-pc.	\$3.75	#1 Square, 4"	161144 1-pc.	\$4.50
#2 Phillips, 3"	161138 1-pc.	\$2.59	#2 Square, 2"	161145 2-pc.	\$2.99
#2 Phillips, 4"	161139 1-pc.	\$4.50	#2 Square, 3"	161146 1-pc.	\$3.25
#2 Phillips, 6"	161140 1-pc.	\$6.25	#2 Square, 4"	161147 1-pc.	\$4.50
#3 Phillips, 2"	161133 2-pc.	\$2.99	#2 Square, 6"	161148 1-pc.	\$6.25
#3 Phillips, 4"	161141 1-pc.	\$3.49	#3 Square, 2"	161149 2-pc.	\$2.99
#3 Phillips, 6"	161142 1-pc.	\$4.99	#3 Square, 4"	161150 1-pc.	\$3.49



HIGHPOINT® Trim Head Screws

Trim head screws heads are 1/3 smaller than their flathead counterparts. Hardened steel screws and fine threads grip well without splitting. #1 Square Drive.

Size	1-4 packs	5+	
#7 x 1"	620128	\$5.99	\$4.49
#7 x 1 5/8"	620130	\$7.99	\$5.84
#7 x 2 1/4"	620132	\$9.29	\$6.92
#8 x 3"	620134	\$13.79	\$10.79
150719 trimhead countersink bit, ea.			\$10.99
154287 (A) SNAPPY 1/8" @ 1/4" twist bit countersink			each \$16.50

FastCap® PowerHead Screws

This unique design completely eliminates driving screws too deep. *Above the surface:* Drill the PowerHead into position so that the entire head sits on your material's surface. *Below the surface:* The PowerHead Screw nibs underneath the 9/16" head cut through to sit perfectly flush with the material's surface (use an impact drill driver). With a type 17 self-drilling auger point, these screws can be driven into most woods without a pilot hole, and wide threads provide greater holding power.

159390 #10 x 2 1/2", 50 pcs., black oxide	\$5.99
159391 #10 x 3", 50 pcs., black oxide	\$7.29

FastCap® Zinc Plated PowerHead Screws

	Qty. 50	Qty. 150		
#10 x 1 1/4"	147462	\$4.50	834205	\$15.50
#10 x 2 1/2"	147484	\$5.50	834867	\$17.50
#10 x 3"	834206	\$6.99		





GARRETT Center Leg Bed Frame Support

This easy-to-install leg eliminates sagging. Vertically adjustments are made, using the provided extender, from 6" to 16". Includes installation instructions.

152691\$21.50

No-Mortise Bed Rail Fittings

You'll find dozens of applications where these no-mortise bed rail fittings will come in handy. Made of heavy-gauge steel with a rustproof, chromate plating, they measure app. 3" tall and use a #10 screw for mounting (not included). "L" bracket mounts to the post of the bed and the plate mounts to the bed rail. Set of four includes two rights and two lefts.

142496 set of 4.....\$12.50



Bed Rail Fastener

Attach rails to posts or use in other K-D furniture applications. Requires full mortise installation. Made of heavy gauge, 5/8" wide steel. Fasteners are 5" long, sold in sets of 4. Mounting screws not included.

127456\$14.99



Bed Bolt Cover And Bolt

Traditional bolt cover in Sheraton styles with an antique brass finish. Square head, 3/8" x 6" long rigid steel bolts provide extraordinary structural support. Bolts are complete with nut and washer.

130213 1 3/4" dia. cover\$7.99

130211 6" bolt\$7.39



HIGHPOINT® Bed Hardware Center Bed Rail Support

This HIGHPOINT® Center Bed Rail Support is the answer to the most perplexing problem when using wooden slats in bed construction: making sure that the center slat is supported in the middle bed rail. Steel with yellow chrome finish.

159294 (A) center bed rail support\$3.99

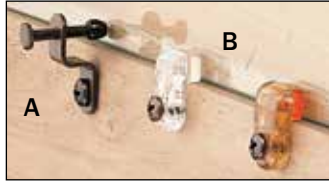

Glass Retainer Clips

(A) **Thumbscrew Retainer.** Firmly holds glass panels in wood frame doors. Thumbscrew adjusts to various door or glass thicknesses. Surface mount on inside of door. Bronze finished steel with mounting screw and plastic tip. Bag of 10 10+ Bags

27A15\$5.29\$4.76

(B) **Plastic Retainers.** Soft plastic retainers hold glass firmly in place. Available in 1/8" or 3/16" offset.

1/8" Offset Bag of 10 10+ Bags

130329 clear\$4.79\$4.31

3/16" Offset Bag of 10 10+ Bags

130327 clear\$4.79\$4.31

130328 brown\$5.50\$4.95

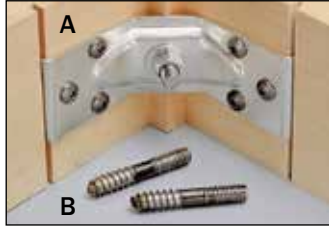

Table Leg Corner Braces

For an economical attachment of table legs to frames. Ends of the brace are set into grooves in the frame. Heavy galvanized steel. 1 1/2" x 4". Mounting screws not included.

Each 10+
27A31 (A).....\$1.75\$1.58

Hanger Bolts (B)

Steel bolt has wood threads on one end and machine threads on the other. Use a 9/32" pilot for softwood or 19/64" bit for hardwood. Packs of 8.

161510 5/16"-18 x 2"\$2.99

161511 5/16"-18 x 2 1/2"\$2.99

161512 5/16"-18 x 3"\$3.49

161513 1/4"-20 x 1 1/2"\$2.99

161514 1/4"-20 x 2\$2.99

161515 1/4"-20 x 3"\$3.49

161516 3/8"-16 x 3"\$3.99



HIGHPOINT® Knockdown Low Profile Bed Hardware

HIGHPOINT® Bed Hardware allows you to assemble a bed frame so that it can be knocked down easily. Bolts, instead of hooks or tapered fittings, are used for fastening brackets to join the bed frame. This fitting takes up a little more room than typical bed hardware, but it is a much stronger connection. 3 1/2" tall. Fastens with included screws. One set completes one bed.

159295 (B) KD low profile bed support\$11.99

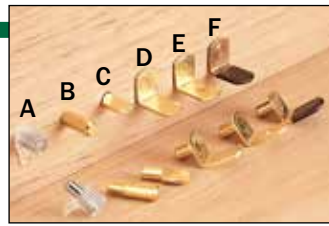

Shelf Pins And Supports

We offer a variety of styles and finishes to fit every shelving need. Bags of 25 each.

(A) **Clear Bracket Style**

27131 clear, 5mm.....\$3.99

(B) **5mm Round Shelf Supports.** Insert in 5mm hole, project 15mm (5/8") into case. Bag of 20 5+ Bags

130339 nickel.....\$5.79\$5.21

130340 brass.....\$5.29\$4.76

(C) **Flat Spoon Style** Bag of 25

27111 brass 1/4".....\$3.50

27132 brass 5mm.....\$3.50

27112 nickel 1/4".....\$3.50

27113 bronze 1/4".....\$3.50

(D) **Bracket Style**

Shank Dia. Bag of 25

27114 brass 1/4".....\$4.79

27133 brass 5mm.....\$4.79

27115 nickel 1/4".....\$5.29

27116 bronze 1/4".....\$5.29

(E) **Bracket Style With hole.** Bag of 25

27118 nickel 1/4".....\$6.29

27119 bronze 1/4".....\$6.29

(F) **Bracket Style Glass Shelf Support**

Brass with brown sleeve. Bag of 25

27120 brass 1/4".....\$4.99

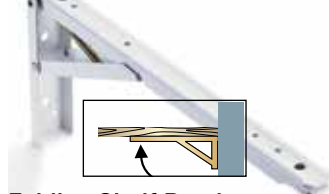

Folding Shelf Brackets

Securely lock themselves in position when raised! Attach to the wall or any vertical surface where a temporary shelf is needed. Rated for 130 lbs./pr. White enamel finish, sold in pairs.

Shelf Width Per Pair 10+ Pair

128943 8"\$13.69\$12.32

128944 12".....\$15.99\$14.39

Cable Management Grommets

If your building new or altering old furniture by cutting holes to run cables and cords through, we have the grommets to help you hide those ugly raw edges. Standard two piece plastic grommets are easy to install, simply drill the appropriate size hole and insert.

Round	white	black	brown	Each	4+
1 1/2"	149802	149803	149804	\$3.75	\$3.38
1 3/4"	149805	149806	149807	\$3.99	\$3.59
2"	149808	149809	149810	\$4.79	\$4.31
2 1/2"	149811	149812	149813	\$5.29	\$4.76
3"	149815			\$6.29	\$5.66



Keyhole Hangers

Used with flat-head screws to join two surfaces together. The tapered plate ensures a snug friction fit. Single hole is 5/8" x 1 5/8", double hole is 1/2" x 3". Two per pack.

Each Pack 10+
125505 single hole\$1.75\$1.57
125506 double hole.....\$2.25\$2.03

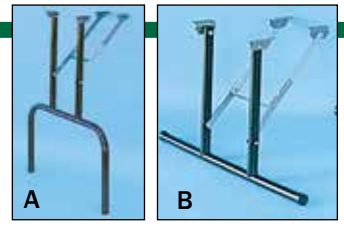

Banquet Folding Legs And Folding Bench Legs

What a great way to add more table space for that next family reunion. Legs are constructed of heavy-duty 1" tubular steel with welded joints. Banquet legs lock open or fold flat for easy storage. Folding Bench Legs feature a wide base for secure mounting and fold flat. Sold in pairs, black.

(A) **Banquet Legs** Pair 3+ Pair
813802\$33.50\$30.15

(B) **Bench Legs**

813803\$35.99\$32.39

Self-Balancing Lid Supports

Spring-loaded and easy to mount on the inside of the lid and box. Touch-control cam action keeps lid open and steady; no fear of it banging down unexpectedly on small hands. Great for toy chests and other drop lid pieces like hope chests, window seats, storage chests, and stereo cabinets. Available in 3 sizes for different lid weights, listed here in inch-pounds. (*Note: to find inch-pound (IP) for a lid, multiply 1/2 the distance of the lid front to back by the lid weight.) Designed for mounting on the left or right of the case, either may also be center mounted. Sturdy bronze finish, screws included.



Left Mount
04X21 35-45 IP* lids.....\$6.50
04X61 45-55 IP* lids.....\$6.50
04Y31 95-125 IP* lids.....\$6.50
Right Mount
04X12 35-45 IP* lids.....\$6.50
04X13 45-55 IP* lids.....\$6.50
04X15 95-125 IP* lids.....\$6.50



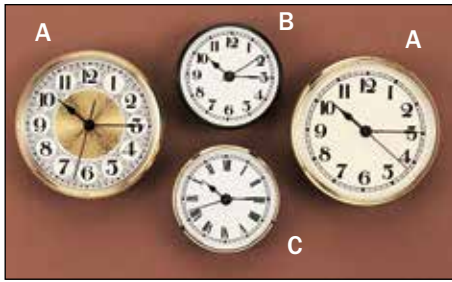

Quartz Clock Fit-Ups

These fit-ups are made in America but feature a diamond cut brass or black finished metal bezel manufactured in the Black Forest of Germany. Selection includes 2³/₈" and 3⁷/₈" diameter fit-ups in both Arabic (A) and Roman (R) numerals featuring dial backgrounds of Classic White (CW), Classic Ivory (CI), and Fancy White (FW). The 2³/₈" diameter fit-ups are also available in a Classic White dial with a black (B) bezel. The 2³/₈" fit-ups require a 1³/₁₆" deep by 2³/₈" diameter hole and use one AAA battery (not included). The 3⁷/₈" fit-ups require a 5⁵/₈" deep by 3⁷/₈" diameter hole and use one AA battery (not included).

See A More Complete Selection Of Clock Fittings at your Woodcraft Store, or visit woodcraft.com

(A) 3⁷/₈" Diameter Brass Bezel

Style	Face	Each	5+
142321	A.....CW.....	\$15.99	\$14.39
142322	R.....CW.....	\$15.99	\$14.39
142323	A.....CI.....	\$17.99	\$16.19
142324	R.....CI.....	\$15.99	\$14.39
152927	A.....FW.....	\$17.50	\$15.75

(B) 2³/₈" Diameter Black Bezel

Style	Face	Each	5+
142316	A.....CW.....	\$14.50	\$13.05
142317	R.....CW.....	\$14.50	\$13.05

(C) 2³/₈" Diameter Brass Bezel

Style	Face	Each	5+
142314	A.....CW.....	\$13.50	\$12.15
142315	R.....CW.....	\$14.99	\$13.49
142318	A.....CI.....	\$13.50	\$12.15
142319	R.....CI.....	\$14.99	\$13.49
152926	A.....FW.....	\$13.50	\$12.15

125946	2 ³ / ₈ " Forstner bit	\$19.99
125952	3 ¹ / ₈ " Forstner bit	\$30.75

Bracket Clock Plan And Hardware Kit

This classic cabinet was designed in England during the 17th century. The bail handle was used to carry the clock from room to room. Drawn full size so you can layout the parts directly from the plan! Hardware pack includes a Westminster chime quartz movement, embossed metal dial, black serpentine clock hands, bail handle, mock key with plate, hinges, magnetic catch and turn buttons. Wood, wood finish, miscellaneous fasteners, battery and glass not included. Finished clock measures 14"H x 11"W x 6¹/₂"D.

145795	plan	\$18.99
145796	hardware kit	\$92.50

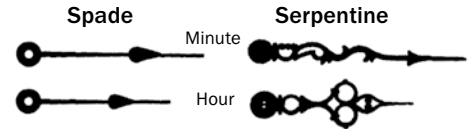

Mini-Quartz Movements

Precision built Mini-Quartz Movements, accurate to within 10 seconds per month, are the ideal choice where minimum depth is required. Runs over 1 year on a single "AA" battery (not included). Includes removable hanger, rear time set and on/off switch and all necessary mounting hardware. Unit is 2¹/₈" x 2¹/₈" x 5⁵/₈" deep, and will fit neatly into a 3" diameter hole.

3" Clock Fit-Up Bit. Economical bit is perfect for drilling holes for the Mini-Quartz Movements.

125951\$24.75

Part #	Dial	Each	5-9	10-24	25+
3609X14	0-1/4" thick	\$6.99	\$6.29	\$6.29	\$6.29
3609X38	1/4"-3/8" thick	\$6.99	\$6.29	\$6.29	\$6.29
3609X58	3/8"-5/8" thick	\$6.99	\$6.29	\$6.29	\$6.29
3609X34	5/8"-3/4" thick	\$6.99	\$6.29	\$6.29	\$6.29



Time Ring	Black	Price
Spade		
3 ⁵ / ₈ " - 3 ³ / ₄ "	4800X	\$2.99
4 ³ / ₈ " - 4 ¹ / ₂ "	4802X	\$2.99
4 ⁷ / ₈ " - 5"	4804X	\$2.99
5 ¹ / ₂ " - 5 ³ / ₄ "	4806X	\$2.99
7" - 3 ¹ / ₄ "	4808X	\$2.99
7 ³ / ₄ " - 8"	4810X	\$2.99
9" - 9 ¹ / ₄ "	4812X	\$2.99
Serpentine		
3 ⁵ / ₈ " - 3 ³ / ₄ "	4820X	\$2.50
4 ³ / ₈ " - 4 ¹ / ₂ "	4822X	\$2.50
4 ⁷ / ₈ " - 5"	4824X	\$2.50
6" - 6 ¹ / ₄ "	4826X	\$2.50
9 ¹ / ₂ " - 10 ¹ / ₄ "	4830X	\$2.99
5 ³ / ₈ " - 5 ¹ / ₂ "	4838X	\$2.99



Rare Earth Magnets, Washers, & Cups

Rare earth magnets are recognized for their superior magnetic force and sheer holding power, and these magnets are true to their word. Use for small lidded boxes, cabinet doors, or applications where normal lid or door closing hardware is aesthetically unappealing. Our washers and cups are all countersunk for use with flat head screws, the 3³/₈", 1¹/₂", and 5⁵/₈" are packaged with ten #4 x 1¹/₂" screws and the 7⁷/₈" and 1¹/₈" are with six #10 x 5⁵/₈" screws. The exterior of the 3³/₈" cups have a ribbed outer surface designed to be press fit or glued into a 3³/₈" x 1¹/₄" deep hole. All measurements given are outside diameter (O.D.) and represent the counter bore to fit the magnets, washers, or cups.

(A) Magnets Width x Height

150949	1/4" x 1/10" (10-pc.)	\$4.25
150950	3/8" x 1/10" (10-pc.)	\$8.39
150951	1/2" x 1/8" (10-pc.)	\$13.69
151008	3/4" x 1/8" (6-pc.)	\$15.79
150952	1" x 1/8" (6-pc.)	\$31.50

(B) Washers

150953	3/8" x 1/8" (10-pc.)	\$5.29
150954	1/2" x 1/8" (10-pc.)	\$6.29
150955	5/8" x 1/8" (10-pc.)	\$7.39
150956	7/8" x 5/32" (6-pc.)	\$7.99
150957	1 1/8" x 5/32" (6-pc.)	\$9.50

(C) Cups

150958	3/8" x 1/4" (10-pc.)	\$5.29
150959	1/2" x 1/4" (10-pc.)	\$6.29
150960	5/8" x 1/4" (10-pc.)	\$6.29
150961	7/8" x 9/32" (6-pc.)	\$9.50
150962	1 1/8" x 9/32" (6-pc.)	\$10.50

Second Hands For Quartz Movements

When selecting a Second Hand, be sure size is less than 1/2 time ring dimension. Not shown actual size.

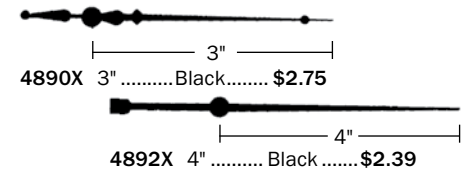

Shaker Knobs

Can be installed in the traditional fashion with their tenon (slightly oversized), or secured with a wood screw if the tenon is cut off. Unfinished. 2 per bag.



Maple Shaker Knobs - 1¹/₄" dia., 1/2" tenon

161867	1 bag	5 bags	10+ bags
	\$2.99	\$2.59	\$2.54

Maple Shaker Knobs - 2" dia., 3/4" tenon

161868	\$4.99	\$4.49	\$4.29
--------	--------	--------	--------



Cloth Backed Felt Sheets

This is the perfect lining felt for all your fine projects. This high quality felt has virtually no lint, and the cloth back helps prevent "fuzzing" along cut edges. The cloth back ensures the felt doesn't tear, stretch, or crease. Coated with pressure sensitive adhesive for simple peel and stick application. Sheets are 35³/₄" long x 23" wide.

142215	green	\$31.99
142216	maroon	\$31.99
142218	royal blue	\$31.99

Technical Questions?

Call 1-800-535-4486
For FREE help, and advice!



Project Supplies

158626

Pizza Cutter Turning Kit, Chrome

No more flimsy pizza cutters or knives to cut that piping hot pizza! From deep dish to thin crust, this well-balanced, heavy-duty chrome plated pizza cutter will handle any style pizza that is tossed in front of it. Turn a personalized handle from your stock for the pre-sharpened, 4"-diameter stainless steel blade to create a one-of-a-kind pizza cutter. Includes pizza cutter and 5/16" x 18 TPI internal threaded insert for easy handle removal when cleaning the cutter.

Each 4+
154265 4" diameter wheel.....\$17.99...\$16.19
158626 2 1/2" dia. mini wheel...\$12.99...\$11.69

154265

Shown as a finished kit, blanks sold separately



WoodRiver® Camp Axe Kit With Sheath

At only a little over 1 lb., this compact Camp Axe Kit is light enough to carry on an extended adventure trip, yet durable enough to handle outdoor chores. Constructed from 420 stainless steel (HRC51-53), it is easy to sharpen but will hold an edge extremely well. Kit includes one camp axe, one black ballistic nylon sheath, two stainless steel rivets, and one wrench. Camp axe measures 11" overall length with a blade length of 2 5/16". Visit your Woodcraft Store, or woodcraft.com for full instructions.

160767 \$27.99

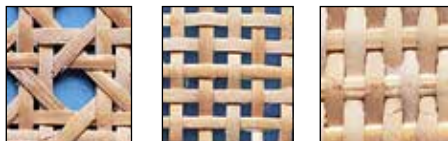

1/2" Conventional Modern Open Modern Closed

Caning Supplies

Woven Natural Cane. For chairs that use a groove and spline around their edge to secure cane. We offer 3 styles of woven cane, all are sold by the running foot. Illustrations are actual size.

1/2" Conventional Weave
50B41 14" width per ft. \$5.25
50B51 18" width per ft. \$7.25
50B61 24" width per ft. \$10.50

Modern Open Weave
50C11 18" width per ft. \$7.99
50C12 24" width per ft. \$12.99

Modern Closed Weave
50C21 18" width per ft. \$6.50
50C22 24" width per ft. \$9.50

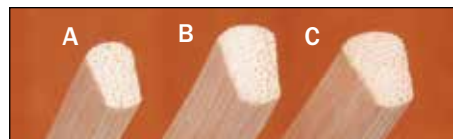

Reed Spline. Secures woven cane into seat and panel grooves. Size is determined by groove width. Sold in 10 ft. lengths, illustrations are actual size.

	Groove Width	Spline Width	Price
(A) 50C31	1 1/64"	9/64"	\$2.99
(B) 50C41	1 3/64"	11/64"	\$3.25
(C) 50C51	7/32"	3/16"	\$3.25

Chair Caning Kit

contains all the material and instructions needed to hand cane a chair. Includes fine chair-cane, binder cane, awl, pegs and illustrated instruction book.

50B20 \$24.99

The Caner's Handbook By Miller & Widess. A descriptive guide with step-by-step photos on restoring cane, rush, splint, Danish cord, rawhide, and wicker. 143 pgs, softcover.

10B75 \$18.95

Visit your Woodcraft Store, or woodcraft.com for full instructions.

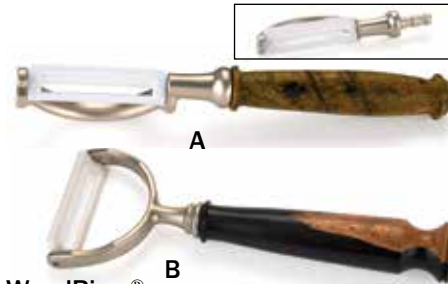

WoodRiver® Ceramic In-Line Vegetable Peeler Turning Kit

The WoodRiver® Ceramic In-line Vegetable Peeler Turning Kit features a heavy-duty casting that holds the ultra-sharp peeler blade made of zirconium oxide ceramic, which is second only to diamonds in hardness and remains sharper longer than any steel. Turning kit requires a 3/4" x 3/4" x 5" wooden or man-made blank, 1/4"-diameter bit, and turning mandrel, all sold separately. This is a great kit for beginners and professional, alike. Visit your Woodcraft Store, or woodcraft.com for full instructions.

160768 (A) \$7.99

WoodRiver® Ceramic Vegetable Peeler Turning Kit

158543 (B) \$7.99

Shown as a finished kits, wood sold separately



WoodRiver® Alaskan ULU Knife Kit

The Alaskan ULU knife was first crafted by Native Alaskan residents over 5,000 years ago and was primarily used by Eskimo women for hide skinning and cleaning fish. Today people everywhere have discovered the versatility of this knife for slicing meats, dicing vegetables and a lot more. The knife's rocking motion makes it extremely easy to use. Since the center of force is concentrated over the middle of the blade, it creates twice the downward force compared to conventional cutlery. Cleaning is a breeze; simply wash your ULU by hand with soapy water in a downward motion from the handle, to avoid the sharp cutting edge, rinse thoroughly and towel dry. Constructed from 440C stainless steel. **DO NOT SOAK IN WATER.** Visit your local Woodcraft Store, or woodcraft.com for full instructions.

161198 \$11.99

Shown as a finished kit, blanks sold separately



SARGE 3-in-1 Bottle Opener Kit

With this kit, you can make your own 3-in-1 bottle opener to remove bottle caps, chip ice, and even shuck oysters. Kit is constructed from 440 Stainless and features an ice breaker tip that also doubles as a tool to shuck oysters. Simply add knife scales of your choice (sold separately), shape, sand, and apply a finish of your choice, and you will have a one-of-a-kind personalized bottle opener. Attach the included black paracord lanyard to keep your opener always at the ready. Overall length is 5 1/4".

159919 \$13.99

Aluminum Finial Turning Kit

This fabulous aluminum turning kit can be used to create one-of-a-kind heirloom Christmas ornaments or add accents to your hollow forms or lidded box turnings by incorporating just the 3/4" finial. Constructed from lightweight, 6061-T6 aluminum, this kit measures 5 3/4" overall length and can be adjusted to a maximum length of 6 3/4" by simply adjusting the 2 1/2" long 10-32 threaded rod. Turning an ornament has never been easier!

159498 \$19.99

Ornament Stands

Display your ornaments and other works of turned art from any one of these decorative display stands. With two sizes and three color/plating options we've got you covered. Three-legged stand measures 12 1/2" tall x 8 1/4" hanging height. Small spiral stand measures 10" tall x 7 1/2" hanging height.

159633 (A) 3-legged chrome plated \$5.99
159634 (A) 3-legged brass plated..... \$5.99
159635 (B) black small spiral \$3.99
159636 brass plated small spiral \$3.99

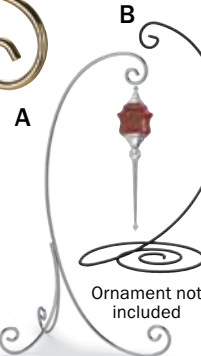

Miniature Hanging Ornament Kits

Create stunning decorative and functional hanging ornaments with these Woodcraft exclusive turning kits. Choose from the three 24k gold plated "end cap" styles and add your wood and turning creativity for amazing results. Overall length of the completed hanging ornaments is approximately 2 7/16" and the "turned" body is approximately 1 3/8" in length. Requires a 7mm brad point or pen makers drill bit, mandrel and pen/pencil bushings 06R03.

Style	Each	10+	20+
126199 A	\$5.29	\$4.76	\$4.49
126206 B	\$5.29	\$4.76	\$4.49
126213 C	\$5.29	\$4.76	\$4.49





Pre-Drilled Travel Mug Blanks

Use our pre-drilled blanks to make a travel mug for yourself or as a gift. By pre-drilling the blanks, we have solved the biggest obstacle to making a larger turning project: the size of the drilling for the initial cleanout. Each blank is 3³/₄" x 3³/₄" x 8"; pre-drilled whole is approximately 2¹/₄" x 6". The laminated blank consists of three pieces of wood – two Maple and one exotic wood of contrasting color that will vary from blank to blank. Finish your mug with our Travel Mug Kit 154508 sold separately.

159372 cherry.....\$30.99

16 oz. Stainless Steel Travel Mug Kit With Screw Top Lid

Create a custom travel mug using your favorite wood or mixed media to produce a one-of-a-kind dramatic effect. You can either turn the outer liner using a stove configuration or simply use solid wood blocks. Although this kit is for an experienced turner, you will find that the hollowing techniques are easy to execute, and the results are nothing short of amazing. Kit contains 16 oz. stainless steel travel mug liner with screw cap lid. Requires a 4" x 4" x 8" blank.

Turning blanks sold separately



Each 4+

154508 mug liner with lid\$9.99....\$8.49

154329



Turning blanks sold separately

Seam Ripper Kits

People have been sewing since the beginning of time, but unfortunately sometimes things sewn must be taken apart. To make those "take apart" tasks easier, turn your own custom seam ripper with this kit that includes a sharp reversible blade, which stores in the handle when not in use, and a pocket clip.

154328 Woodcraft gold\$6.99
 154329 chrome\$6.50
 154330 bushings.....\$4.75
 154331 repl. tubes.....\$2.99
 161509 repl. "O" rings.....\$2.99



WHITESIDE Professional

3/8" Bottle Stopper Mandrel, Triple-Flute
 The beefy 3/8" shaft of this mandrel will easily fit into any collet, keyed or keyless chuck and features triple tapping flutes that assist in cutting threads easily into your turning stock. Removal of the turning stock will become much easier than ever before, and the installation of the stopper will be a snap. Requires a 9mm hole for harder denser material, or an 11/32" hole for softer material.

161630\$14.99



WHITESIDE Professional 1/4" Bottle Stopper Mandrel Double-Flute

Fits easily into any collet, keyed or keyless chuck. Simply drill a 7/32" hole in your wooden blank, thread onto the mandrel, and turn your favorite shape.

161629\$9.99

Chrome Bottle Stopper Kit

Turning blanks sold separately



Solid chrome stoppers with silicon rubber "O" rings seal the bottle and, unlike traditional cork stoppers, do not transfer taste and smell to other bottles. Requires 6mm bit and mandrel listed below. The Starter Set is a great value – it includes 4 kits, mandrel and bit.

144631 starter set\$36.99
 822942 bottle stopper kit (1).....\$6.89

Turning blanks sold separately



Stainless Steel Bottle Stoppers

Designed to last a lifetime! Our 300 series stainless steel bottle stopper may be a little more expensive than the traditional chrome, but are well worth the extra expense. These stoppers are not plated, but are 100% solid stainless steel so in addition to being corrosion resistant they will not flake or pit. **Stainless Steel Stopper** measures 3¹/₈" length.

150868 (A) stainless steel stopper.....\$14.29
 149124 6mm pen maker's bit.....\$2.99
 149766 repl. bottle stopper O-rings (10) \$8.49

Stainless Steel Cone Stopper measures 2⁵/₈" length x 59/64" top diameter with a 3/8" – 16 tpi threaded stud.
 150767 (B) cone bottle stopper.....\$14.29

Stainless Steel Mini Cone Stopper comes in 2" length x 47/64" top diameter with a 3/8" – 16 tpi threaded stud.
 150968 (C) mini cone stopper\$7.99
 153584 adj. bottle stopper mandrel.....\$9.99

Black Titanium Stopper Kit

Turning blanks sold separately



Black Titanium enhances the appearance of your stoppers and increases durability since it is less susceptible to pitting or flaking.

Each 5+
 148874\$10.59.....\$9.53
 149766 repl. bottle stopper O-rings (10) ..\$8.49



Turning blanks sold separately

WoodRiver® Stainless Steel Bottle Stopper Turning Kits

Designed to last a lifetime, these 300 series stainless steel bottle stoppers are 100% solid stainless steel, so they are corrosion resistant and will not flake or pit like some others on the market. Materials used are food- and pharmaceutical industry-safe, so cross contamination will not be an issue. In addition, these kits include a solid food grade silicone insert that will fit securely in any bottle. Turning kit requires a 1¹/₂" x 1¹/₂" x 2¹/₂" wooden or man-made blank, 1¹/₃₂" bit, and mandrel, all sold separately.

159490 (A) red\$9.99
 159491 (B) black.....\$9.99

Tear Drop Bottle Stopper Kit

Turning blanks sold separately



This new tear drop shape sits lower in the bottle's mouth and features a fluted black silicone seal. Heavy chrome plating resists corrosion.
 Each 10+ 20+
 149242\$5.29.....\$4.76.....\$4.49



Turning blanks sold separately

WoodRiver® Stainless Steel Paddle Ice Cream Scoop Turning Kit

Serious lovers of ice cream deserve a serious ice cream delivery system. Constructed from solid 304 Stainless, this WoodRiver® heavy-duty scoop features a wide paddle shape designed to cut through the hardest of ice creams, a 3/8" x 1 13/8" 16 TPI threaded post and a beefy ferrule to cap it all off. Our scoop is designed to seal off the end of your turned handle so that no grain is exposed to the elements. This project is easy and fun to make and will last a lifetime. In addition to the kit, you will need a minimum 1 3/4" x 1 3/4" x 6" piece of turning stock, turning tools, 3/8" or 9mm brad-point drill bit, five-minute epoxy, and finish.

159072\$16.99

Turning blanks sold separately



WoodRiver® Stainless Steel Ice Cream Scoop

Sweet treats deserve a sweet scoop! Constructed from 304 Stainless this heavy-duty scoop features a hawk bill point designed to cut through the hardest of ice creams, a 3/8" x 1 13/8" 16 TPI threaded post and a beefy ferrule to cap it all off. Our scoop is designed to seal off the end of your turned handle so that no grain is exposed to the elements. This is an easy and fun project to make that will last for a lifetime. Requires 1 3/4" x 1 3/4" x 6" turning stock, 3/8" or 9mm brad point, five-minute epoxy, and a finish of your choice.

153928\$14.99

Turning blanks sold separately



WoodRiver® Bottle Opener Kit

Create a bottle opener that will make a great accessory in any kitchen or bar. Simply mark center, drill a 3/8"-diameter hole by 1 5/16" deep, mount the blank between centers, and let your imagination do the rest. We have found that a 4 1/2" – 5" handle works the best. Once the handle is completed, epoxy the opener into the previously drilled hole. Opener measures approximately 1 7/8" wide by 3 1/4" tall and has a 3/8" x 16 TPI x 1 5/16" long threaded post.

Each 4+
 154264\$7.99.....\$7.19

Turning blanks sold separately



WoodRiver® Coffee Scoop Turning Kits

WoodRiver® offers the perfect kit for the coffee fanatic in your life. This easy-to-make kit will bring smiles for years to those loved ones in your life every morning as they use this scoop to make the perfect cup of java. Each scoop is equal to one tablespoon. Choose from our large selection of wood and manmade blanks to create your one-of-a-kind scoop. Blank material not included.

157778 gold.....\$7.99
 157779 chrome.....\$7.99

Project Supplies

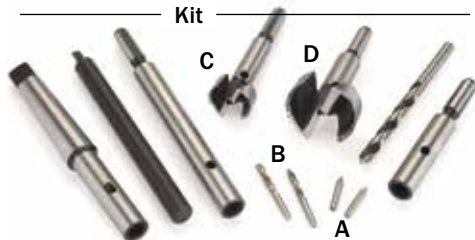

FISCH Pepper Mill Boring Kit

The FISCH Pepper Mill Boring Kit is the ultimate package for boring pepper mill blanks. Featuring the multi-function Wave Cutter forstner bits, this set contains all of the necessary bits to bore up to a 12" blank. The bits' scalloped edge, called the

"Wave Cutter," allows for a clean, quick cut while reducing the tendency for the bit to catch in the wood or "walk" across the work surface. The FISCH Pepper Mill Boring Kit also features exchangeable center point and center drill bits, which allows the user to choose the proper tip for the wood species being used. Kit contains the following: (1) 1 1/16" Wave forstner bit, (1) 1 5/8" Wave forstner bit, (1) 93mm extension, (1) 150mm extension, (1) 7mm brad-point twist bit, (1) #2 MKII Morse taper adaptor, (1) dismantling tool, (2) 4mm center twist drill bits, and (2) cone tips.

- 160218 pepper mill boring kit\$149.99
- 160381 (A) repl. centering cone tips, 5-pc. \$6.99
- 160382 (B) repl. 4mm twist centering bits,
3-pc.\$7.99
- 160383 (C) 1 1/16" wave cutter forstner bit \$39.99
- 160384 (B) 1 5/8" wave cutter forstner bit \$49.99

Turning Blanks
Sold Separately

Lighted Electric Pepper Mill Turning Kit

Everyone can always use an extra hand in the kitchen, and now you can have one. The fully adjustable ceramic grinding mechanism in this kit will allow you to dispense coarse to fine peppercorns with just a push of the button, leaving one hand free for other tasks. A single light has been built into the base of the unit allowing you to see where your seasoning is being dispensed. Kit requires 4AA alkaline batteries and a 3" x 3" x 6" blank for the turned body (all sold separately).

- 158541\$19.99

Shown as a finished kit, turning blanks sold separately

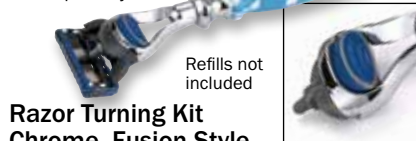

Refills not included

Razor Turning Kit Chrome, Fusion-Style

Everyone deserves to be pampered, and our Fusion-style Chrome Razor Kit will do just that. Not only is our durable chrome accented razor kit a pleasure to turn, but you will appreciate the way it functions even more. Use any Gillette Fusion® refill with this kit. Choose from our extensive selection of wooden and man-made pen blank materials, and head to your lathe to create a one-of-a-kind razor today. Refills not included.

- 161461\$12.99

Turning Blanks
Sold Separately



Razor Kits

A pleasure to turn for a great shave. This durable chrome accented razor kit accepts any standard Gillette MACH3®@refill.

- 151092 chrome\$13.50
- 151093 bushings for razor kit\$5.69
- 151094 repl. tubes for razor kit (5-pc.)....\$4.29
- 151091 (A) shaving brush kit.....\$10.25



Pre-Drilled Pepper Mill Blanks **NEW!**

Making a pepper mill is an enjoyable project that produces a useful kitchen tool or a great "anytime" gift! The biggest obstacle to making a pepper mill of any size is drilling the stepped through hole. We've solved the problem by pre-drilling our most popular pepper mill blanks. 12" blank is 3" x 3" x 11 3/4" overall and a 3" x 3" x 9" shaft. 9" blank is 3" x 3" x 9" overall and a 3" x 3" x 6" shaft.

- 158266 cherry, 12", (shown).....\$20.39
- 159367 cherry, 9".....\$18.39
- 158269 African mahogany, 12".....\$25.79
- 159400 African mahogany, 9".....\$21.69
- 158267 maple, 12".....\$23.49
- 159368 maple, 9".....\$19.99
- 159369 maple, curly, 12".....\$29.99
- 159370 maple, curly, 9".....\$25.79
- 159374 padauk, 12".....\$31.19
- 159375 padauk, 9".....\$25.49
- 158268 sycamore, 12".....\$20.69
- 159366 sycamore, 9".....\$17.99
- 158902 walnut, 12".....\$30.59
- 159371 walnut, 9".....\$25.79

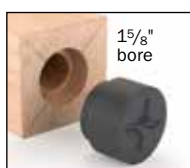

Salt & Pepper Mill Jamb Chucks, 2-piece

Would you like to save time and make it easier to turn a salt or pepper mill? Woodcraft has designed a pair of premade poly jamb chucks to fit the 1 1/16" and 1 5/8" standard bores of a mill. The jamb chucks will not mar or damage your turning material or tools. The larger 1 5/8" can be driven by either a 4-jaw chuck or a 4-prong drive spur. Eliminate the guess work and increase your productivity and accuracy of turning with our jamb chucks.

- 158353\$18.50



Turning Blanks
Sold Separately

WoodRiver® Garlic Press Turning Kit

The elegant garlic press features 1 5/64"-diameter x 1"-long threaded arms to attach your handle design. Constructed from durable cast material and chrome plated to a mirror finish. Turning stock for handles sold separately.

- 158919\$12.99

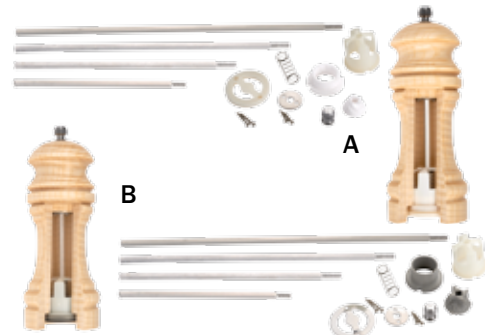

WoodRiver® Salt and Pepper Mill Grinder Mechanism Turning Kits

WoodRiver® Salt and Pepper Mill Grinder Kits offer quality and flexibility. Our Salt Mill kit features a quality ceramic grinding mechanism that ensures an exceptional grind, while our Pepper Mill kit features a quality tempered stainless steel mechanism that provides a lifetime of grinding. WoodRiver kits come with four different shaft lengths that offer flexibility. No need to struggle with what length to make your mill - with 6", 8", 10", and 12" shaft lengths included, you have ultimate control over the length of your mill. Most grinder kits require a precisely bored-through hole, but the unique mounting hardware of our kits allows slight inaccuracies in your turning. Easy to assemble and install, the mechanism can be adjusted from extra coarse to an extra fine grind by turning the knurled knob on top of the mill. Kits come complete with instructions and all hardware to make one Salt or one Pepper Mill. Wood or man-made blank for the body sold separately.

- 161463 (A) pepper\$12.99
- 161464 (B) salt.....\$12.99

Antique-Style Hand Crank Pepper Grinder Kit Mechanism

Our Antique-Style Hand Crank Pepper Grinder is a simple and straightforward turning kit using any 3" x 3" wood blank by whatever length you desire. Just mark the center and drill a 1"-diameter hole through the center of the blank. Mount the blank between centers with a jamb chuck. Next turn to your desired profile, sand, finish, and attach the grinder to the top of your turned piece. Now you have a one-of-a-kind antique looking pepper grinder. Grinder mechanism measures 2" in diameter x 4 3/8" tall and features a bronze finish, cast metal parts, and a finial that adjusts for coarse to fine granules.

- 154182\$12.99

Wood & Acrylic Blanks
Sold Separately



Stubby Soft Touch Stylus Kits

Create your own custom Capacitive Soft Touch Stylus kit for your touch screen devices. Kit features a non-marring (marking) Capacitive Soft Touch Silicone Stylus Tip that will work on popular touch screen devices such as the iPad®, iPhone®, Android™, and other capacitive touch screens. Non-conductive plug-in secures stylus in standard earphone jack socket.

- 153726 gold\$4.99
- 153727 chrome\$4.75

Turning blanks sold separately



Ceramic Pepper Mill Mechanisms

Wood Mechanism - create traditional as well as up-side-down mills. The simplest design is 4 to 8 inches high, but you can build a mill as tall as you desire.

Shaft Mechanism-create new and innovative stopper designs. This mechanism can be mounted using the built-in "catchers" or glued in place. The top is fixed into the stopper, which can be removed to re-fill the mill. Mill height can range from 5 to 12 inches.

146927 wood mechanism\$14.99



ZHEN Carving Knife And Fork Kit

Add a touch of beauty and elegance to the holidays or any special occasion! This stunning carving knife and fork kit has been hand forged from high quality 440 High Carbon Japanese Steel (HRC 56-58) and then sharpened and polished to a razor-sharp edge. Designed for the professional, the weight and balance combination allows for ease and comfort of use for prolonged periods of time. Choose from our wide variety of knife scale material to create your treasured heirloom.

154324\$69.99



PEN BLANKS & KNIFE SCALES
PAGE 154



WoodRiver® Knife Kits

It's easy to build beautiful custom knives that everyone will admire. Kits come with screw together scale (handle) rivets and either stainless steel or the striking looking Japanese laminated steel blades. Blades are pre-shaped and ground, just pick your favorite wood for the scales and create a truly one of a kind knife. Kits include the blade, rivets and instructions. Scales (handles) and 30 minute epoxy not included. Countersinks listed below make a perfectly centered countersink for the head over the rivet shaft hole. Models A and B use counter sink B; Model C, E and F uses countersink A; Model D uses countersinks A and B, below.

(A) Skinner Knife Kit. 6" overall length, 2 1/4" stainless steel blade. Knife scales not included.

148357\$19.99.....\$17.99



Samples Shown As Finished Kits

Knife Scales Sold Separately

ZHEN Premium Damascus Knife Kits

ZHEN Premium Damascus Knife Kits are forged in Japan utilizing years of knowledge and skill in knife making and technology and then shipped to Taiwan for grinding, sharpening and application of the tang. Each high quality blade is crafted by forge welding 66 layers of steel around a core layer of VG - 10 steel (HRC 60 - 62) so each blank has its own unique surface pattern and razor-sharp edge. Designed with the professional chef in mind, these knife kits are a perfect gift for anyone who enjoys cooking. The bread knife is constructed from Japanese high carbon stainless steel (HRC 54 - 56) and features a granton edge (non-stick scallops) to help release thin slices and sticky food. Handle material sold separately. blade length overall length

- 153651 (A) cleaver 6 9/16" 11 5/8"\$79.99
- 153652 (B) nakiri 6 1/4" 11 1/2" \$65.99
- 153653 (C) chef's kn. 7 9/16" ... 12 3/4" \$70.99
- 153654 (D) santoku 4 3/4" 9 5/16" \$39.99
- 153655 (E) parer 3 5/16" 7 11/16" \$22.99
- 153656 (F) bread kn. 9 1/2" 14 5/8" \$17.99
- 159483 (B-F) 5-pc. kit **Save!** \$184.99
- 153929 (A-F) 6-pc. kit **Save!** \$253.99
- 153927 pilot & counterbore \$17.99

WHITESIDE Pilot Drill & Counterbore

Whiteside Machinery created the perfect tool for boring and countersinking the rivets included with the ZHEN Premium Damascus Knife Kits. The depth of bore will depend on the thickness of your knife scale.

153927 \$17.99

(B) Drop Point Hunter Knife Kit. 7 1/4" overall length, 3" stainless steel blade with finger grip relief make this a great general purpose hunting, fishing or camping knife. Knife scales not included.

148358\$19.99.....\$17.99

(C) Spear Point Knife Kit. 8 1/2" overall length, 4 1/4" blade length. Single edged. Knife scales not included.

148362\$25.99....\$23.39

(D) Tanto Style Knife Kit. 11 1/2" overall length, 6 1/8" blade length. Specialized blade shaped for penetration. Knife scales not included.

148359\$36.50....\$32.85

Laminated Steel Knife Kits. The pattern of the steel laminations on these blades makes each blade truly unique. The swirling, waving lines of the laminations combined with your custom handle will make knives which stand out from the ordinary. Use countersink B, below.

Knife Rivet Countersinks make perfect centered rivet head countersinks in your knife handles.

148553 countersink size A \$11.99
148554 countersink size B \$11.99



Shown as finished kits, Knife Scales sold separately

Tom Kreger Carolina Field Knife Kit

The unique design of the Kreger Carolina Field Knife makes it a great addition to any hunting enthusiast's or knife collector's arsenal. The 1 1/8" wide by 3 1/2"-long blade is substantial enough to tackle any game animal out there. Crafted from 440C stainless steel, this kit features a fixed blade design with polished finger guard. This razor-sharp hunting knife is perfect for skinning any size game animal. Just shape, mount and finish your custom handle to complete this one-of-a-kind, high quality knife. Overall length is 7 1/2". Kit includes pre-sharpened blade, scale pins, and detailed instructions. Knife scales sold separately.

159182 \$35.99

Knife Scales Sold Separately

SARGE Mini Hunter Fixed Blade Knife Kit

Do not be fooled by the size of the Mini Hunter. This compact drop point blade is tough enough for any game animal. The polished 2 5/8" 440C stainless steel blade features a fixed blade design with polished finger guard. This razor-sharp hunting knife is perfect for skinning any size game animal. Just shape, mount and finish your custom handle to complete this one-of-a-kind high quality knife. Overall length is 6 1/8". Kit includes pre-sharpened blade, scale pins, and detailed instructions. Knife scales sold separately.

159181\$24.99

Finished example in synthetic bone. Handle Material Sold Separately



SARGE Desk Knife/Letter Opener Kit

Build your very own custom desk knife/letter with classic elegance! The 440C polished stainless steel Desk Knife Kit is 6 1/8" overall length with a 2 3/4" flat-ground blade. Kit also includes brass pins and a fitted leather sheath for safe storage. You will want to leave this one on the desktop for all to see.

157858\$19.99

Knife Scales Sold Separately



SARGE Liner Lock Folder-Blade Kits

With these kits, you can make a high-quality knife without the metalworking tools or expertise required to make the blade. The large knife has a 3 1/4" overall length blade (4 5/8" closed length) and is made from 440C stainless steel that has been hollow ground and polished to a beautiful satin finish. The small knife has a 2" overall length blade (2 3/4" closed length) and is made from 440 stainless steel with black TiN coating for blade protection. Complete instructions are included. Knife scales sold separately.

153377 (A) large \$17.99
153378 (B) small \$14.99

Pen Kits

Woodcraft Pen & Pencil Kits are available in a wide variety of finishes and plating options. Here at Woodcraft we only offer the best in Fit, Finish, and Function from the highest quality plating to smooth operating mechanism for our discerning customer.

Standard Gold Plating While Gold plating is the most common pen finish it is ultimately not the most durable. No matter how it is done, all gold plating will wear off over time when abraded. Gold plating can be made more durable depending on the method, additives and the techniques used to plate.

Cobalt Gold Plating All of the gold plating we use on our kits is "upgrade Gold", meaning our parts are plated utilizing the "rack method" where small amounts of either cobalt or palladium are added to the plating chemicals. This process enhances the durability and longevity of the gold plating. Others may employ a tumbled method that produces an inferior gold plating.

Woodcraft Gold (WCG)/Titanium Gold (TG) Plating This process, called PVD (particle vapor deposition), produces our most

durable gold plating. Titanium nitride is matched to the color of the gold and is molecularly bonded to the parts, 24K gold is then bonded (sputtered) on to the parts to achieve the color match. These parts are then re-plated, so that they will virtually never wear, and to achieve a Rockwell hardness of approximately 85 providing an extremely durable finish.

Chrome Plating Chrome plating is extremely durable and beautiful and will remain vibrant for many years.

Platinum Plating Other kit manufacturers may use rhodium, but we plate with real platinum because of its luster, wear and corrosion resistance.

Black Titanium Utilizing the same process as the Woodcraft gold, titanium oxide is molecularly bonded using the PVD process. This plating is extremely hard and durable while giving the appearance of changing colors - from a Smokey gray to silver when moved under light.

Satin This beautiful matte finish provides a unique and different look. This long wearing finish is available in gold, nickel, and pearl.



Same-Kit Quantity Discounts Save!

Buy 10 any one kit - Save 10%!

Buy 20 any one kit - Save 15%!

Buy 50 any one kit - Save 20%!

Buy 100 any one kit - Save 25%!

Shown as finished kits,
Wood sold separately

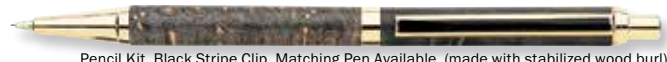

Pencil Kit, Black Stripe Clip. Matching Pen Available. (made with stabilized wood burl)



Pen Kit, Solid Clip. Matching Pencil Available. (made with stabilized wood burl)



Pen Kit, Satin Finish, Deco Spring Clip. (made with cocote)



Pen Kit, Satin Finish, Straight Clip. (made with cocote)

Slim Style Pen & Pencil Kits

Pen Kits utilize a premium locking "S-groove" twist action. Pencil Kits feature newly engineered tips that are free acting and smooth, eliminating the troublesome mechanism "hang-ups". This fool proof, non-jamming tip is specially designed to feed the correct amount of .5mm lead with each click of the plunger top.

Cobalt Gold	Each	10+	20+
123052 solid clip pen kit.....	\$3.50	\$3.15	\$2.97
123080 solid clip pencil kit.....	\$5.09	\$4.58	\$4.32
123059 black stripe clip pen kit.....	\$3.99	\$3.59	\$3.39
123087 black stripe clip pencil kit.....	\$5.29	\$4.76	\$4.49



Black Titanium	Each	10+	20+
822947 solid clip pen kit.....	\$8.99	\$8.09	\$7.64



Copper	Each	10+	20+
148778 solid clip pen kit.....	\$5.29	\$4.76	\$4.49

Satin Finish	Each	10+	20+
142506 nickel deco spring clip pen kit...	\$5.99	\$5.39	\$5.09
142505 gold deco spring clip pen kit.....	\$7.50	\$6.75	\$6.37
142507 pearl deco spring clip pen kit.....	\$5.99	\$5.39	\$5.09
141656 nickel straight clip pen kit.....	\$4.50	\$4.05	\$3.82
142415 nickel straight clip pencil kit.....	\$6.75	\$6.08	\$5.74
141655 gold straight clip pen kit.....	\$4.50	\$4.05	\$3.82
142416 gold straight clip pencil kit.....	\$6.99	\$6.29	\$5.94
141657 pearl straight clip pen kit.....	\$4.50	\$4.05	\$3.82
142414 pearl straight clip pencil kit.....	\$6.75	\$6.08	\$5.74



Pen Kit, Platinum Finish, Straight Clip. (made with cocobolo)

Platinum Finish	Each	10+	20+
147074 platinum straight clip pen kit.....	\$5.29	\$4.76	\$4.49
147075 platinum straight clip pencil kit..	\$6.39	\$5.75	\$5.43



American Slim Style Solid Clip Pen. Matching Pencil Available. (made with redheart)



American Slim Style Black Stripe Clip Pencil. Matching Pen Available. (made with redheart)

American Slim Style Solid Clip & Black Stripe Pens And Pencils

Feature a classic ball tip clip and unique stylized center rings. Black Stripe clip kits have a black filled center ring, Solid Clip kits have a gold "engraved" look center ring. These kits have the same specifications and utilize the same high quality mechanisms as our regular pen and pencil kits. Cobalt Gold finish.

	Each	10+	20+
124644 solid clip pen kit.....	\$5.99	\$5.39	\$5.09
124637 black stripe clip pen kit.....	\$5.99	\$5.39	\$5.09
124658 solid clip pencil kit.....	\$6.89	\$6.20	\$5.86
124651 black stripe pencil kit.....	\$7.39	\$6.65	\$6.28



WoodRiver® Slim Style Cobalt Gold Ballpoint Pen Kits, 10-Packs

A classic straight barrel design with a premium locking "S-groove" twist action. Our pen clips do not require notching of the barrel like other, more difficult-to-make kits. Requires a 1/2"x 1/2" x 5" blank, 7mm pen maker's or Brad point bit, mandrel and pen/pencil bushings, all sold separately. Durable plated finish.

Solid Cobalt Gold Clip	2-4 kits	Black Insert\Gold Clip	2-4 kits
123053	\$31.50	\$28.35	123060 (A).....\$35.90.....\$32.31

European Style Pen, Pencil Kits

Choose between standard Gold Cap or Black Cap style. Black Cap kits feature a double ringed center ring and stylized ball tip clip.



European Style Gold Cap Pen. (made with charcoal Dymondwood)

European Style Pen Kit

Utilizes the same single twist mechanism and 7mm boring process as our regular pen kits.

Standard Gold	Each	10+	20+
06S45 gold cap pen kit (shown)	\$8.50	\$7.65	\$7.23
124962 black cap pen kit	\$6.89	\$6.20	\$5.85

Woodcraft Gold	Each	10+	20+
128260 gold cap pen kit	\$12.29	\$11.06	\$10.44
128262 black cap pen kit	\$12.29	\$11.06	\$10.44

Other Finishes	Each	10+	20+
141659 satin nickel pen kit	\$7.50	\$6.75	\$6.38
141658 satin gold pen kit	\$7.19	\$6.79	\$6.39
141660 satin pearl pen kit.....	\$7.50	\$6.75	\$6.38
145652 black titanium pen kit	\$13.79	\$12.41	\$11.72
147072 platinum pen kit.....	\$7.49	\$6.74	\$6.36
839366 copper.....	\$6.09	\$5.48	\$5.17

European Style Pencil Kit

Fashioned after our European style pen and letter opener kits, to create your own customized executive desk sets. Features a premium German pencil mechanism. Uses .5mm lead.

Standard Gold	Each	10+	20+
123480 gold cap pencil kit.....	\$13.79	\$12.41	\$11.72

Shown as finished kits, turning blanks sold separately



Wall Street II Grip Ballpoint Pen Kits

The sleek, smooth and refined lines of this pen and the distinct feel of the ergonomic tri-grip in your hand are sure to make it a winner. Featuring single-tube construction, this pen is the easiest to assemble of any kit we offer. Nib/nib holder, center ring and the top finial/clip are both preassembled. Simply turn the body, press in the top finial/clip assembly, screw the ink refill mechanism on the nib assembly, push the two halves together, and you are finished. Visit woodcraft.com for full instructions.

160803 (A) gunmetal & chrome.....	\$14.99
160804 (B) chrome & gunmetal	\$12.99
160805 (C) chrome & Woodcraft gold.....	\$12.99
161243 brass repl. tubes, 5-piece.....	\$2.50
146597 bushings.....	\$4.99

Wall Street Pen And Pencil Kits

If you appreciate the sleek, smooth lines and ease of turning and assembly the Wall St. Pen or Pencil Kits are the answer. Simply turn the body, press in the top finial/clip assembly, screw the ink refill mechanism on the nib assembly, push the two halves together and the pen is finished.

Wall Street II Pen Kits

		Each	10+	20+
A		\$7.69	\$6.92	\$6.54
B		\$15.99	\$14.39	\$13.59
C		\$18.99	\$17.09	\$16.14
147460 (C) black titanium w/plat.....		\$17.99	\$16.19	\$15.29
148777 copper.....		\$9.39	\$8.45	\$7.98
148764 chrome two tone.....		\$11.50	\$10.35	\$9.77
834131 chrome.....		\$6.99	\$6.29	\$5.94
149244 black titanium		\$16.99	\$15.29	\$14.44
150547 black chrome		\$12.39	\$11.15	\$10.53

		Each	10+	20+
A		\$11.39	\$10.25	\$9.68
B		\$10.69	\$9.62	\$9.09
153121 satin black w/black chrome		\$12.99	\$11.69	\$11.04

Wall Street II Ballpoint Pen Kits With Soft Touch Stylus

This kit features a non-marking Capacitive Soft Touch Silicone Stylus Tip in the end cap finial that will work on popular touch screen devices such as the iPad®, iPhone®, Android™, and others. This new generation features the easiest assembly of any pen kit we offer.

153686 gold	\$10.49
153687 chrome.....	\$9.49

Wall Street II Letter Opener Kit

If you appreciate the sleek, smooth lines and ease of turning and assembly of the Wall St. II Pen and Pencil kits now you can turn a pen and a letter opener all from one 5 1/2" blank.

150549 Woodcraft gold	\$11.69
150550 chrome.....	\$11.69

A
Wall Street II "Click" Pen
 Features a new non-rotating click mechanism for smooth and consistent operation. The nib/nib holder, center ring and the click mechanism/clip are pre-assembled. Simply turn the one tube body, press in the threaded ring for the nib assembly, press in the click mechanism/clip assembly, screw on the nib assembly and the pen is finished! Available in HRD-2000g wearing gold and true Platinum finishes. Requires Wall Street II bushings (146597).

	Each	10+	20+
148461 (A) gold	\$9.59	\$8.63	\$8.15
148462 platinum	\$15.99	\$14.39	\$13.59
149178 black titanium	\$17.99	\$16.19	\$15.29
149243 copper.....	\$11.69	\$10.52	\$9.93
150546 black chrome	\$9.99	\$8.99	\$8.49
146597 Wall St.II bushings.....	\$4.99		

Elegant Wall Street II Click Pen Kits

	Each	10+	20+
150865 black titanium/platinum.....	\$19.99	\$17.99	\$16.99



Wall St. II Pencil Kits

Match the finish with your favorite Wall St. II pen and make stunning pen and pencil sets that everyone will admire.

	Each	10+	20+
149354 (A) gold	\$10.59	\$9.53	\$9.00
149356 (B) copper	\$9.39	\$8.45	\$7.98

Wall St. III Pen Kit

With a finished body diameter of just over 1/2", the Wall St. III is designed to fit larger hands perfectly.

	Each	10+	20+
148106 gold	\$8.99	\$8.09	\$7.64
153082 satin black/black chrome	\$13.99	\$12.59	\$11.89
153084 chrome.....	\$8.99	\$8.09	\$7.64



Lever Action Ballpoint Pen Kit

Old meets new - the authentic lever action mechanism that extends and retracts this ink pen refill brings to mind the look and feel of the lever action rifle made famous by the cowboys of the American West. The intricate filigree details and beautiful deer image on the cap are extremely crisp and clean. This irresistible kit looks amazing and is extremely fun to make. Visit your Woodcraft Store, or woodcraft.com for full instructions.

160832 lever action pen kit, antique brass.....	\$19.99
161460 lever action pen kit, antique nickel	\$19.99
149127 WoodRiver® 10mm drill bit.....	\$8.50
153198 Whiteside 3/8" pilot shaft	\$9.99
160833 replacement tubes, 5-piece	\$2.99
160834 bushings.....	\$4.99

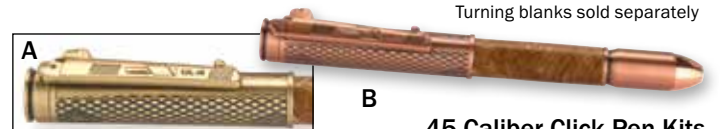

.45 Caliber Click Pen Kits

One of the most recognizable caliber handguns is the .45 ACP. The details that have been incorporated into this kit feature checkered grips, primer cap end, the .45 caliber style bullet nib, and the gun slide clip make this the perfect pen kit for any target shooter or gun enthusiast. Kit features a smooth operating click mechanism and is complemented by the Parker style ballpoint ink refill. Kit requires a 10mm pen maker's bit, sold separately. Pen blank sold separately.

159929 (A) antique brass	\$14.99
159930 (B) antique copper	\$14.99
159931 replacement tube, 5-pc.	\$3.99
150488 bushings.....	\$6.99

Visit your Woodcraft Store, or woodcraft.com for full instructions.

Pen Kits

Princeton Pen Kits

The sleek, smooth lines and ease of turning will make the Princeton Pen Kits one of your favorites. Features include a classic style roller clip, similar to those developed by the Boston Pen Company around the turn of the century, a smooth operating single twist transmission, and a Parker-style ball-point pen refill.

153188	titanium gold	\$14.99
153189	chrome	\$8.50
153190	black titanium (shown)	\$14.99
153191	platinum	\$10.50
153192	Princeton bushings	\$3.99



Roller Clip European Style Pen Kit

This classic style clip is similar to those developed by the Boston Pen Company around the turn of the century. Kits feature the same high quality components of our regular European style pens, but with a roller clip.

Standard Gold	Each	10+	20+				
126454	roller clip pen kit	\$7.89	\$7.10	\$6.70

Turning blanks sold separately



Atlas Ball Point Pen Kit

Atlas Ball Point Pen with Standard Gold finish.

Unique and stylish, this easy to make pen kit uses a single tube design that really shows off your best blanks. The knurled top twists to extend and retract the premium "Parker-style" refill. Length is approximately 5½".

	Each	10+	20+				
149246	copper	\$7.49	\$6.74	\$6.36
147203	standard gold	\$5.89	\$5.30	\$5.00
147204	black enamel	\$5.89	\$5.30	\$5.00
147205	platinum	\$8.49	\$7.19	\$6.79
149180	black titanium	\$10.59	\$9.53	\$9.00



Click Ball Point Pen Matching Pencil Available. (made with brown stabilized wood burl)

Click Ball Point Pen And Pencil

The time tested push button ballpoint pen is probably in more pockets than any other style pen. Now you can turn your own beautiful wooden ballpoint pens and matching pencils to replace those ugly plastic ones. Easily turned with straight sides, or can be profiled to create custom looks. Standard Gold finish.

	Each	10+	20+				
127671	click pen kit	\$4.79	\$4.31	\$4.07
128960	click pencil kit	\$5.49	\$4.94	\$4.66

Turning blanks sold separately



Sedona Screw-Cap Rollerball Pen Kits

The rounded ends, gracefully flared clip and unique center band combine for a striking appearance. The six-faceted nib gives the look of changing shades as light reflects from the angled surfaces. Overall closed length approx. 5⅝".

	Each	10+	20+				
148852	gold	\$12.79	\$11.51	\$10.87
148853	chrome	\$13.50	\$12.15	\$11.47

Turning blanks sold separately



Navigator Screw-Cap Pen Kits

Light reflecting from the six-faceted nib holder gives the look of changing shades of gold tones. Featuring a custom spring pocket clip, tapered finial with black inlay, and single thin black line center ring.

	Each	10+	20+				
148851	chrome	\$12.25	\$11.03	\$10.41
146018	cobalt gold	\$12.50	\$11.25	\$10.62
149177	black titanium	\$20.19	\$18.17	\$17.16
149909	satin nickel	\$14.50	\$13.05	\$12.33
149910	sterling silver fountain	\$21.29	\$19.16	\$18.10
149911	black titanium fountain	\$31.89	\$28.70	\$27.11

Teacher's Pen Kit

The "blue" end for writing, the "red" end is for grading, using 7/8" lead (148262) and blue (148285) acrylic blanks, with a 2¼" wood main body finished to 6" long. Uses 7mm bushing and drill bits.

	Each	10+	20+				
149474		\$5.99	\$5.39	\$5.09
149850	refills (10)	\$8.50				



B



Cartridge Bullet Pen Kits

This is the perfect pen for the outdoorsman or hunting enthusiast. The kit looks like a real 30 caliber shell right down to the copper plated nib. This unique kit features a double twist mechanism for ease of use, and is complemented by the Parker style ball point pen refill.

150486	chrome	\$11.50
150487	(A) Woodcraft gold	\$10.99
150488	bushings	\$6.99
150489	repl. brass tubes (5)	\$3.50

Cartridge Bullet Button Click Pen Kit

This is the perfect pen for the outdoorsman or hunting enthusiast. The kit looks like a real 30 caliber shell right down to the copper plated nib. This unique kit features a smooth operating click mechanism for ease of use, and is complemented by the Parker style ball-point pen refill.

151303	Woodcraft gold	\$12.50
151304	(B) chrome	\$11.99

Wood & Acrylic blanks sold separately



Turbin Stylus Ballpoint Click Pen Kits

Easily switch from writing a note to surfing the Web with just the click of a button. That's right, the Turbin Stylus Pens from these kits write like a traditional style ballpoint pen but also allow you to surf the Web with the durable non-marring rubber tip. Simply click the mechanism to retract the ink refill inside, and the stylus is ready to help you navigate the Web on your favorite device. Visit your Woodcraft Store, or woodcraft.com for full instructions.

160806	chrome	\$5.99
160807	Woodcraft gold	\$7.99
160808	gunmetal	\$6.99
160809	replacement tubes, 5 pair	\$3.99
160810	bushings	\$4.99

Hart Double-Twist Pen Kit

This pen is a perfect "in between" size. Smaller than the Classic American Style pens, but larger than the Slim Style pens. This easy-to-turn kit does not require any parting or tenons for the center ring. Double-twist mechanism turns left or right to extend the ball point, turn to center to retract.

	Each	10+	20+				
145229	gold	\$6.39	\$5.75	\$5.43
828438	chrome	\$6.39	\$5.75	\$5.43



Woodworker's Artist's Pencil Kit

Equally at home in the shop or an artist's sketch kit. The extra thick (5.66mm, about 29/64" D x 3 1/8" L) HB round lead resists breaking and is held firmly in place by a four jaw collet at the bottom of the pencil mechanism. Just push on the spring loaded top of the pencil and the collet opens to advance or retract the lead. The top, when unscrewed from the pencil, features an internal sharpener to renew the point. Standard gold finish.

	Each	10+	20+				
146767	pencil kit	\$13.99	\$12.59	\$11.89
146769	4B soft lead (2)	\$1.50				
146770	HB hard lead (2)	\$1.50				
147263	colored lead assortment	\$5.29				

Wood & Acrylic blanks sold separately



WoodRiver® Magnifying Glass Kit

Offered in a 2½" diameter glass with a 3½" handle. This kit is extremely well made and have the heaviest glass retaining rings we've seen, not the lightweight pot metal you'll find in other kits. Standard Gold finish. Kits require a 7mm pen maker's or Brad point bit, mandrel, and pen/pencil bushings. The kit uses a 5/8" x 5/8" x 3 3/4" blank.

	Each	10+			
09P37		\$12.25	\$11.03
149762	repl. tubes, 5-piece	\$2.19		





Cigar Pen. Matching Pencil Available.
(made with claro walnut)

Cigar Letter Opener Kit.
(made with cocobolo)

Premier Cigar Pen, Pencil & Letter Opener

Unique black and gold accent banding, combined with the heavy "flat" clip, form a pen which is truly like no other. The **Cigar Pen** uses single twist mechanism, overall length is 5½", top diameter ⅜". Standard Gold finish. **Cigar Pencil** has all the features of the Cigar pen, uses a premium German pencil mechanism. **Cigar Letter Opener** utilizes a different bushing than the pen and pencil kits.

	Each	10+	20+
147155 cigar pen kit, std. gold	\$6.99	\$6.29	\$5.94
148749 cigar pen kit, blk. titanium	\$11.59	\$10.43	\$9.85
828439 cigar pen kit, chrome	\$7.25	\$6.52	\$6.16
147156 cigar pen kit, platinum	\$11.50	\$10.35	\$9.77
147157 cigar pen kit, bright black	\$7.99	\$7.19	\$6.79
148779 cigar pen kit, copper	\$8.99	\$8.09	\$7.64
153085 cigar pen kit, satin black	\$8.99	\$8.09	\$7.64
150867 cigar pen kit, satin nickel	\$6.99	\$6.29	\$5.94
150866 cigar pen kit, satin silver	\$6.99	\$6.29	\$5.94
147158 cigar pencil kit, std. gold	\$12.50	\$11.25	\$10.62
144870 cigar letter opener, gold	\$8.50	\$7.65	\$7.23

Hybrid Cigar Pen

This classic but elegant design features exquisite high-end plating's that are sure to please the most demanding of pen turners. The Hybrid pen utilizes a double twist mechanism for ease of use, and is complemented by the Parker style ball point pen refill.

	Each	10+	20+
149767 titanium w/platinum	\$16.99	\$15.29	\$14.44
152607 black titanium w/gold	\$16.99	\$15.29	\$14.44



Samples Shown
As Finished Kits

Ultra Cigar Pens

Ultra pens have distinctive, elegant designs in the nib, center, and finial rings that carry over onto the robust clip and finial top. Available with gold contrasted by chrome or the opposite.

	Each	10+	20+
148460 gold w/chrome	\$15.50	\$13.95	\$13.17
148459 chrome w/gold	\$15.50	\$13.95	\$13.17
149248 satin chrome	\$15.50	\$13.95	\$13.17
147161 cigar pen bushings	\$5.25		
149127 10mm pen makers bit	\$8.50		

Soft Grip Stylus Kits

Non-marring (marking)
Capacitive Soft Touch

Silicone Stylus Tip. Soft rubber grip provides hours of fatigue free surfing.

158289 chrome	\$5.99
158290 gold (shown)	\$5.99
158291 gunmetal	\$6.99
158292 bushings	\$5.25



Breast Cancer Awareness Soft Grip Pen Kits

Almost everyone knows someone who has been directly impacted by breast cancer. Now you can stand up and show your support for those who have been affected by breast cancer with a Soft Grip Breast Cancer Awareness Pen Kit. This easy-to-turn, twist style pen uses the same 7mm tubes and twist mechanism as the slim style pens, but features a fuller shape, unique pink ribbon clip and pink soft grip. Kit requires a ¾" x ¾" x 5" blank, a 7mm pen maker's bit, bushings and mandrel, all sold separately.

158716 Woodcraft gold	\$8.50
158717 chrome	\$7.99
145228 bushings	\$5.50
06R68 replacement tubes	\$4.59
Solid pink acrylic balnk, ¾" x ¾" x 5"	
158718	\$4.99

Breast Cancer Awareness 7mm Slim Style Pen Kits

This kit utilizes a classic straight barrel design with a premium locking "S-groove" twist action. Requires a ½" x ½" x 5" blank, 7mm pen maker's bit and pen/pencil bushings, all sold separately.

158714 chrome	\$6.50
158715 gold	\$6.99



Turning blanks
sold separately

WoodRiver® Revolver Action Pen Kits

Wild Bill Hickok, Annie Oakley, and Kit Carson are all names that come to mind when we think of the Wild West as well as the six-shot pistol – still used today. All pen kit components are precision machined and constructed from aluminum allowing details in this kit like no other. The fluted cylinder, authentic looking pistol clip, durable plating, and the silky smooth operating click mechanism will make this one of your favorite pens. This kit is perfect for the history buff and shooting enthusiast alike.

160149 Bright Aluminum	\$19.99
160150 Matte Black	\$19.99
160151 Gunmetal	\$19.99
160152 Satin Nickel	\$19.99
160153 Replacement Tubes	\$4.99
160161 Revolver Bushings	\$5.99
160154 Brown Leather Pen Sleeve	\$4.99



El Grande Rollerball & Fountain Pen Kits

These large rollerball and fountain kits have a beautiful yet simple bold new look. Their size and styling shows off fancy woods much better than smaller pens. Because they use larger tubes than other big-bodied pens they are much lighter and better balanced. Easy to make straight tubes with no parting.

	Each	10+	20+
144632 roller ball kit, std. gold	\$10.59	\$9.53	\$9.00
144633 fountain pen kit, std. gold	\$11.69	\$10.52	\$9.94

Metro Pen Kits

Metro Pen Kits produce pens with elegant contours and sophisticated lines, which set this kit apart from any other. The design of the nib gives this pen a soft feel for precise control and hours of writing enjoyment. Metro kits feature a unique roller clip that allows for easy insertion into a shirt pocket while matching the contour of the kit.

154679 rollerball Woodcraft gold	\$14.99
154680 rollerball chrome	\$12.99
154681 fountain pen Woodcraft gold	\$15.99
154682 fountain pen chrome	\$13.99
154683 replacement tubes	\$4.99
154684 bushings	\$7.99



A Slim Style B Ballpoint Stylus Pen Kits

Enjoy the classic straight barrel design and premium locking "S-groove" twist action that enables a smooth twisting action for extending or retracting the ink refill. This kit features a replaceable Capacitive Soft Touch Stylus Tip in the end cap finial that will work on popular touch screen devices such as the iPad®, iPhone®, Android™ and other capacitive touch screens.

154326 (A) Cobalt Gold w/Black Stripe	\$5.99
154327 (B) Chrome w/Black Stripe	\$5.99

Stylus Replacement Tips

154645 (A) Chrome/Black	\$3.49
154650 Gold/Black	\$3.99

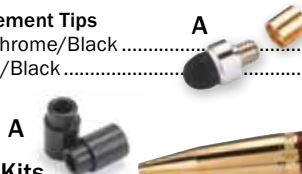

Pluma Pen Kits

The sleek, smooth, refined lines of this pen and its distinct feel in your hand are sure to make this one of your favorite pen kits. The elegant crosshatch pattern on the accent bands and cap enhances the beauty of the kit and aids operation of the twist mechanism. Kit requires a pen blank, bushing set (146597) and 27/64" pen maker's bit, all sold separately.

158627 chrome	\$10.99
158628 gunmetal	\$12.99
158629 Woodcraft gold (shown)	\$12.99
158630 replacement tubes	\$2.99
146597 (A) bushings	\$4.99



Pen Kits

Shown as finished kits, turning blanks sold separately



Dugas Tri Function Pen Kit

How are you at multitasking? The Dugas Tri Function Pen Kit makes multitasking easy. You could be signing important documents one minute and navigating the Web the next with the rubber, non-marring stylus, and if you need a little light to see in the dark, remove the body and rotate 180° to expose a powerful LED light to illuminate your path. The Dugas Tri Function Pen Kit is named for the late Gary Dugas, a member of the Woodcraft family for 20 plus years. Gary's attention to detail and pleasant personality are missed by all who knew him. Visit your Woodcraft Store, or woodcraft.com for full instructions.

160811	chrome	\$10.99
160812	Woodcraft gold	\$12.99
160813	replacement tubes (5)	\$2.99
160814	bushings	\$4.99
160815	replacement stylus tip	\$1.99



Turning blanks sold separately



Kojent Pen Kits

Wow, elegant, and impressive are just a few words that describe the Kojent Pen Kits. These well-balanced, two-piece pen kits provide a myriad of pen style and plating options. The simplistic but elegant kit design features high quality platings, ink refills, and double twist mechanisms. You are sure to find several fountain, rollerball, or ballpoint pen kits you want to turn into pens for your family and friends – and yourself. Kit requires a 10.5mm and 12.5mm pen maker's bits, sold separately.

159743	(A) fp, cobalt gold & chrome	\$21.99
159744	fp, cobalt gold & gunmetal	\$22.99
159745	(B) rb, chrome & gunmetal	\$17.99
159746	(C) rb, cobalt gold & chrome	\$17.99
159747	(D) rb, cobalt gold & gunmetal	\$19.99
159748	(E) rb, gunmetal & cobalt gold	\$19.99
159749	bp, cobalt gold & chrome	\$12.99
159750	bp, chrome & gunmetal	\$12.99
159751	bp, cobalt gold & gunmetal	\$13.99
159752	bp, gunmetal & cobalt gold	\$14.99
151264	bushings rb/fp	\$8.99
152728	bushings	\$5.99
151527	10.5mm pen maker's bit	\$10.00
151528	12.5mm pen maker's bit	\$10.00



Shown as a finished kit - opener, template & wood sold separately

STARR

Stationary Bottle Openers & Cap Catcher

STARR bottle openers and cap catchers are second to none in quality, materials, castings, and finishes. Designed to be permanently mounted on your bar, wall, or plaque. Mounting screws included.

160385	(A) Starr "X" bottle opener	\$7.99
160386	(B) Starr standard bottle opener	\$7.99
160387	(C) Starr bottle cap catcher	\$8.99

MDF router template for bottle opener project

160708		\$6.99
--------	--	--------



inertia

INERTIA Pen Kit *Just A Flick Of The Wrist!*

With just the flick of the wrist you are ready to write. That's right, no push buttons or twist mechanisms. Just flick your wrist, and the force exerted extends the ink refill of the innovative pen in this kit. Packed with the WOW factor, this pen is the perfect size for pocket or purse – and when you need to surf the web, flip it to use the non-marring soft tip stylus for navigating your touch screen devices. Select a kit in a color that suits your personality.

159226	(A) black	\$19.99
159322	(B) silver	\$19.99
159323	(C) gray	\$19.99
159324	(D) red	\$19.99
159325	(E) blue	\$19.99
159228	replacement tubes, 5 pcs.	\$3.99
159326	replacement ink refills, 3 pcs.	\$1.99
159227	bushings	\$6.50
159327	WoodRiver® pen bit letter "V"	\$5.99

Visit your Woodcraft Store, or woodcraft.com for full instructions

Shown as finished kits, turning blanks sold separately



EMPEROR Twist Pen Kits

Give yourself a "royal experience" with an Emperor Twist Pen Kit that features a silky smooth single twist mechanism, durable platings, and a Schmidt® ink cartridge. The sleek, refined lines and wonderful weight balance in your hand will make this one of your favorite pens. Kit requires an 11/32" pen maker's bit and 3/4" x 3/4" x 5" pen blank (both sold separately).

159321	(A) chrome/black	\$19.99
159322	(B) gunmetal	\$22.99
159234	replacement tubes, 5 pcs.	\$3.99
159233	bushings	\$6.50
149132	11/32" pen maker's bit	\$5.99



ACCORD Pen Kits

Show off the beauty of your blanks! The 3 1/2"-long body in this kit allows you to showcase a beautiful natural or man-made pen blank. The Accord kit features a silky smooth single twist mechanism, premium Schmidt® ink cartridges, and durable platings. The weight and feel of this pen will surely make it one of your favorites. Kit requires a 3/8" pen maker's bit and a 3/4" x 3/4" x 5" pen blank (both sold separately).

159229	(A) chrome	\$19.99
159320	(B) gunmetal	\$22.99
159231	replacement tubes, 5 pcs.	\$4.99
159230	bushings	\$6.50
149133	3/8" pen maker's bit	\$6.50



Fiji Pen Blanks

No two will ever be alike! The intense grain patterns are the result of hand selected figured burl wood caps painstakingly cast in colored resins for stability. When ready for finish, several dense coats of thin CA can be used to seal the wood and create a uniform sheen over the entire blank. Blanks measure 3/4" x 3/4" x 5 1/4".

151150	(A) burgundy	\$19.99
151152	(B) lavender	\$19.99
151153	(C) Pacific blue	\$19.99
158888	strawberry parfait	\$19.99

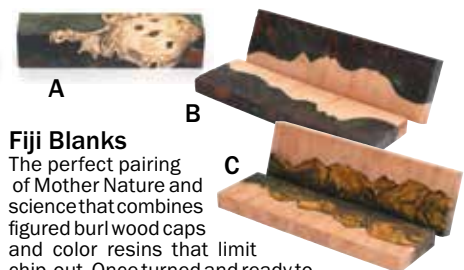

Fiji Blanks

The perfect pairing of Mother Nature and science that combines figured burl wood caps and color resins that limit chip-out. Once turned and ready to finish, multiple coats of a thin CA should be used to seal the wood. Selection includes pen and bottle stopper blanks and knife scales.

160093	(A) 3/4" x 3/4" x 3 1/2" PB, camo	\$10.99
160094	3/4" x 3/4" x 5" PB, camo	\$19.99
160095	1" x 1" x 6"	\$24.50
160096	(B) 3/8" x 1 1/2" x 5" KS, camo, 2-pc.	\$30.89
160097	3/8" x 1 1/2" x 5" KS, onyx, 2-pc.	\$30.89
160098	(C) 3/8" x 1 1/2" x 5" KS, jasper, 2-pc.	\$30.89
160099	(D) 1 1/2" x 1 1/2" x 2" BS, blue ice	\$17.99
160100	(E) 1 1/2" x 1 1/2" x 2" BS, lavender	\$17.99
160101	(F) 1 1/2" x 1 1/2" x 2" BS, burgundy	\$17.99





OVER 130 Acrylic Pen Blanks to choose from.
 Visit woodcraft.com or your local Woodcraft store to
 see the selection! *Quantity Discounts Available!*

Our wide range of acrylic pen blanks offer the pen maker an unmatched selection of vibrant colors and patterns. Acrylic blanks take a beautiful polish that gives the appearance of a liquid tube, no top coat finish is necessary. 3/4" x 3/4" x 5" blanks turn and drill easily. We recommend using Micro-Mesh sanding kit #145982 for the ultimate polished finish.

Each **5+ Save 10%** **10+ Save 20%**

Acrylic Blanks \$4.99 \$4.49 \$3.99



148209 Purple Rain



159564 Pink Quartz



148241 Purple Haze



159563 Pretty In Pink

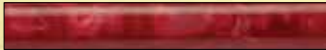

148227 Rage Red



148570 Black



148197 Copper Haze



148257 Water



150825 Grasshopper



148225 Egg Plant



152766 Scarlet & Gray

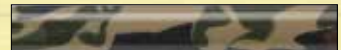

150829 Jungle Camo

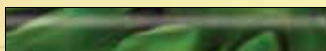

148218 Kelly Green



149154 Caramel Popcorn



148194 Scarlet Mesh



148170 Blue Agate

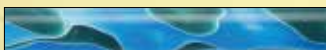

148253 Sea Foam



154039 Uncle Glam

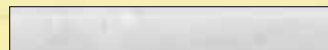

148172 Opal

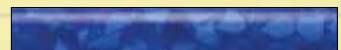

148285 Royal Blue

Fan Favorite Acrylic Pen Blanks

Show your team spirit and pride with Woodcraft Fan Favorite Acrylic Pen Blanks.

160849	160850	160851	160852
160853	160854	160855	160856
160857	160858	160859	160860
160861	160865	160866	160867

Support Your *Favorite* Team With 16 Color Combinations! Visit woodcraft.com or your local Woodcraft store to see the selections!

Acrylic Turning Stock – 1 1/2" x 1 1/2" x 6"

These larger sized acrylic turning blanks come in eye-popping colors and are easy to turn and finish for an amazing look. Together with our turning kits, these blanks offer endless possibilities for creating larger turned items.

Acrylic Turning Stock Is Great For:

- Ice Cream Scoops
- Duck Calls
- Bottle Stoppers
- Pizza Cutters

159085 (A) Sapphire Water	159089 (E) Green Goblin
159086 (B) Blue Bayou	159090 (F) Ghost Trails
159087 (C) Rose Water	159091 (G) Ruby Waters
159088 (D) All Hallows	159092 (H) Purple Neon

1 1/2" x 1 1/2" x 6" Acrylic Turning Stock \$15.99 each

Featuring Green Goblin Turning Stock, 159089. Paddle Scoop Turning Kit Sold Separately, 159072.

Pen Kits

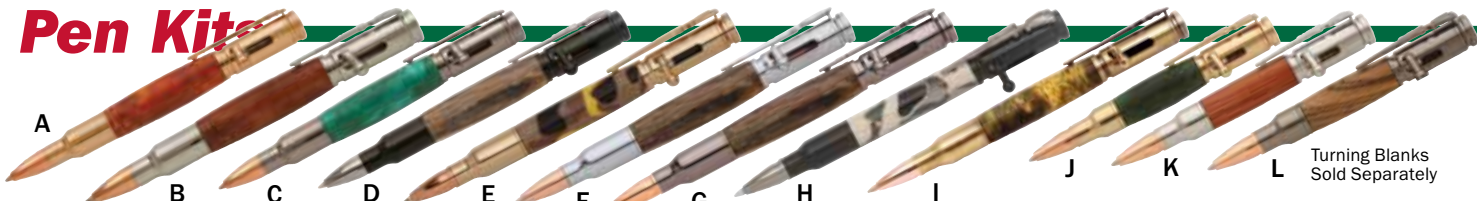

Bolt Action Pen Kits

This Bolt Action Pen Kit is sure to be a hit among hunters and target shooters alike. The kit's realistic look, function and innovative bolt action design used to extend and retract the ink refill will make it your most used writing instrument. No matter how big or small you may be, with three sizes to choose from you will have no problem finding the right one to fit your hand.

Visit woodcraft.com for full instructions.

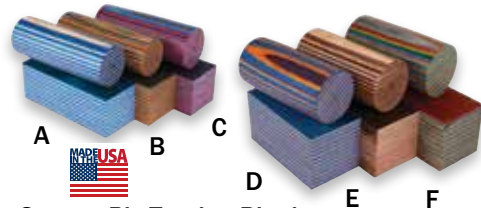

SpectraPly Turning Blanks

SpectraPly uses a process that laminates premium yellow birch veneer into some of the most vibrant and beautiful colored wood material found. SpectraPly, commonly found and used throughout the firearms industry as gunstock material, is also used in crafts, specialty sports, outdoor and woodturning markets when making game calls, bow handles, pistol grips, sling shots and much more. Experience the absolute best in color depth, consistency and overall stability with SpectraPly. Made in the USA.

	2" x 2" x 6"	3" x 3" x 11 1/2"	
	\$12.99	\$29.99	
Caribbean Waves.....	154090 (A)	154084	
Gem Wood.....	154091 (D)	154085	
Patriot.....	154092 (C)	154086	
Ember Glow.....	154093 (B)	154087	
Royal Camo.....	154094 (E)	154088	
Confetti.....	154095 (F)	154089	

Visit your Woodcraft Store, or woodcraft.com for full instructions.

159235	(A) magnum 24-kt. gold.....	\$17.95
159236	(B) magnum chrome.....	\$15.95
159237	(C) magnum gunmetal.....	\$15.95
159238	(D) magnum black enamel.....	\$16.95
857037	magnum bushing set.....	\$6.99
159239	magnum repl. tubes, 5-piece.....	\$2.65
853677	(E) bolt act. 30 cal. 24-kt. gold..	\$14.95
853675	(F) bolt act. 30 caliber chrome..	\$12.95

853676	(G) 30 caliber gunmetal.....	\$12.95
856753	(H) 30 caliber black enamel.....	\$13.95
860993	(I) 30 caliber antique brass.....	\$14.95
850047	bolt & mini bolt action bush. set	\$6.99
857409	bolt action repl. tubes, 5-pc.....	\$4.99
859227	(J) mini blt. act. 30 cal. 24-kt. gld.	\$12.95
859228	(K) mini blt. act. 30 cal. chrome	\$10.95
859229	(L) mini bolt act. 30 cal. gunmtl.	\$10.95
859230	mini bolt act. repl. Tubes, 5-pc..	\$2.65



WOODPECKERS® Pen Blank Center Finder With Scale

The American made Woodpeckers® Pen Blank Center Finder has been designed to make a turner's first critical layout task easier and more accurate. The Woodpeckers Pen Blank Center Finder will work on round or rectangular blanks up to 1 1/4" in thickness or diameter. Machined to exacting tolerances, this little tool will make a big difference in your pen and pencil production. The rigid, right-angled registration surfaces enable you to grip the jig and the workpiece firmly together with one hand. The diagonal marking edge is perfectly machined to provide a beefy surface to guide a sharp pencil or pointed scribe.

158248\$29.99

WoodRiver® Pen Blank Center Finder Key Chain

A must have for any turner! Locate the center of your small turning quickly and accurately on blanks up to 1 1/8", either round or rectangular.

158247\$4.99



Brown Leather Single Pen Sleeve

Pen kits sold separately Display, sell, or present your handcrafted pens or pencils in this split leather sleeve. Sleeve is 5 3/4" long x 1 1/4" wide and will hold one of most double-barreled pens. Pen not included.

159568\$1.99

Black Leather Single Pen Sleeve

Add the "WOW" factor to your handcrafted pens and pencils in this beautifully crafted black grained leather sleeve. Sleeve is 5" long x 1 7/16" wide and will hold one of most single-barreled pen styles. Perfect fit for the Inertia pen kits. Pen not included.

159567\$2.99

Black Velvet Single Pen Sleeve

Add value and show off the beauty of your handcrafted pens or pencils in this Velvet Pen Sleeve. Sleeve measures 5 1/2" long x 1 5/16" wide and holds one of most single- or double-barreled pens.

159569\$0.99



STAT™ Premium Game Call Turning Kits

Turn your very own double reed STAT Premium Duck Call today with this two-piece kit. Proudly made in the USA, this durable polycarbonate kit will provide improved sound quality to make this your favorite go-to duck call. Combine kit with a beautiful accent band to add strength and value to your game call.

Kits: includes (1) polycarbonate call, (1) short Mylar reed, (1) long Mylar reed, and (1) wedge*

159350	(A) Clear, Polished.....	\$11.99	159358	(E) Brass Accent Band, Plain.....	\$3.30
159352	(B) Green, Polished.....	\$11.99	159361	(F) Brass Accent Band, Knurled.....	\$6.50
159354	(C) Black, Polished.....	\$11.99	159359	(G) Chrome Accent Band, Plain.....	\$3.90
159356	(D) Amber, Polished.....	\$11.99	159362	(H) Chrome Accent Band, Knurled.....	\$7.40
			159360	(I) Gunmetal Accent Band, Plain.....	\$3.50
			159363	(J) Gunmetal Accent Band, Knurled.....	\$7.50
			159364	(K) Tooling/Turning Kit.....	\$7.99
			159365	(L) Lanyard (Single).....	\$4.25

Accessories

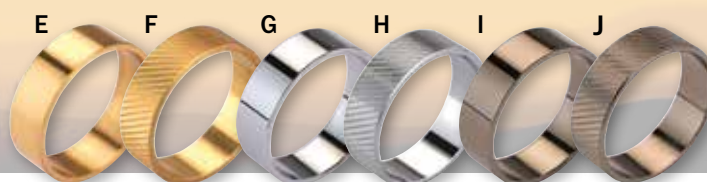

Woodcraft Duck Call Turning Video Link





Pen kits sold separately

WoodRiver® Pen And Pencil Premium Carry/Display Case

This new WoodRiver® Premium Pen and Pencil Carry/Display Case features durable, rugged aluminum construction so your pens and pencils will arrive safe and unharmed. Feet have been added to the outside of the two halves, allowing them to lie completely flat or be separated to form two individual display trays. Tray inserts pull up so a leg can be unfolded to create an easel for better display of your creations. The felt covered insert trays allow for 36 pens or pencils (18 per tray) to be held securely in place by a dual row of elastic cord. Case measures 15 3/8" L x 7 7/8" W x 2 1/2" T.

160928\$39.99

Pen kits sold separately



WoodRiver® Zippered Pen Portfolio

Protect those one of a kind pen creations with the heavy-duty zippered portfolio that will hold up to 24 pens and pencils. A protective interior flap keeps pens from rubbing against one another when closed and large elastic loops hold your pens in place and ready for display. Display Case Holds 24 Pens.

149851\$16.99

Pens Not Included



WoodRiver® Black Faux Leather Pen Case With Dual Sided Insert

Display, sell, or present one or two pens or pencils in this handsome case. Beautiful black faux leather with ivory exterior accent stitching. The interior features an ivory felt upper and lower interior liner with retainer sash over two slotted trays. Dimensions: 6 7/8" long x 2 3/4" wide x 1 9/16" tall. Pens not included.

161796\$5.99

Leatherette Pen Cases

Add value and show off the beauty of your work. Display, sell, or present your handcrafted pens or pencils in this handsome durable Leatherette, soft-sided protective case. Single pouch with a tuck-in flap. 6" x 1 1/4".

Pen kits sold separately



Each 10+
147269 single pouch\$4.75... \$4.27

Pen Display Case With Lid

Display case holds up to 32 larger diameter pens. Black simulated leather outer shell, with grey felt interior and brass latches. Measures 14" L x 7 1/2" W x 2" H. Pens not included.

149898\$37.99

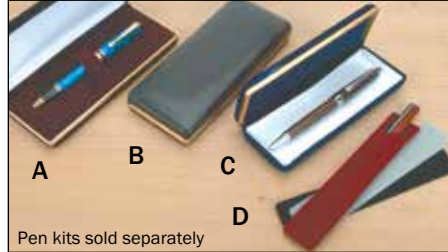

Pen kits sold separately

Pen And Pencil Cases

Add value and show off the beauty of your work. Display, sell, or present your hand-crafted pens and pencils in these handsome cases.

Velvet and Leatherette Presentation Cases. All models feature interiors with a retainer sash to keep your pen or pencil securely in place. Holds up to 2 pens and/or pencils. Each 10+

(A) **Black velvet**, gold trim w/red velvet interior.

125833\$3.25\$2.92

(B) **Black leatherette**, gold trim w/black velvet interior.

124804\$4.25\$3.82

(C) **Blue velvet**, gold trim w/blue velvet interior.

124806\$3.25\$2.92

(D) **Pen Sleeves.** Imitation velvet pen sleeves. Sleeves are 5 3/4" long x 1" wide and hold one pen or pencil of any style. Sold in packages of 10.

123949 red\$5.25\$4.72

123951 black\$5.25\$4.72

123953 gray\$4.99\$4.50

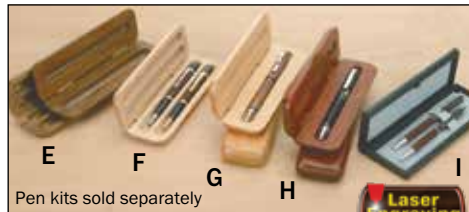

Pen kits sold separately

Lacquered Hardwood Cases

Walnut (E) Each 10+
06R24 single\$5.99\$5.39

Oak (F)
06R26 single\$6.50\$5.85

06R27 double\$6.99\$6.29

Maple (G)
06R95 single\$4.99\$4.50

06R96 double\$5.99\$5.39

Rosewood (H)
06R93 single\$6.50\$5.85

06R94 double\$6.99\$6.29

(I) **Black Plastic Case.** Velvet upper and lower liners with an interior retainer sash.

06R98\$2.15\$1.80

HUT Ultra Gloss Plastic Polish

Simply sand your turnings to 800 grit and polish to give plastic a glass-like polish in seconds. 8 oz. bottle.

129302\$10.99



Woodturner's Pen Finishing Kit

The Woodturner's Pen Finishing Kit includes everything you need to perfectly finish a small turning project. Kit includes: WoodRiver® Turner's Sanding Pack (148558), Micro-Mesh Pen Sanding Kit (145982), HUT Crystal Coat (141049), and HUT Ultra Gloss Plastic Polish (129302).

153666 Complete Kit - SAVE!\$57.50

141049 (A) Crystal Coat, 6 oz., only\$16.99

145982 (B) Micro-Mesh Pad set, only.....\$14.99

Acrylic Pen Stand

Put your pens on a pedestal! This clear acrylic stand lets in plenty of light for maximum shimmer. The pens are visible from all angles, and the clear stand keeps the focus on your pens. Great for displaying at craft shows. Holds up to 7 pens in a variety of sizes.



123944\$15.99

Waterfall Pen Display Stand

Uniquely display up to 10 small or large body pens in minimal space with this Waterfall Stand. The clear plastic makes an attractive rack that doesn't detract from the beauty and craftsmanship of your pens. It stands 9 1/2" high while the footprint is only 3 1/2" x 6 3/4". Pens not included.

147486\$13.50

Pen kits sold separately



Round Pen Tube

Pen Not Included

This 7/8" diameter clear plastic round case will showcase your handcrafted pens in a manner that provides excellent visibility but affords total protection. Packed 10 cases per package.

147485\$10.99



Trapezoid Pen Case

Pen Not Included

The unique shape and flip top opening of this new pen box will complement any pen you place in it. Constructed of maple with naturally contrasting darker hardwood ends, this wooden pen box really stands! For pens 1/2" or smaller in diameter and a maximum of 6 7/8" in length.

127951\$4.99

**MORE WOOD & KITS
PAGES 151-157**



Pen Kits

WoodRiver® Deluxe Pen Press



The unique design of this press allows for quick, easy adjustments at the press of a button. Simply press the release button to move the threaded rod to the desired position, adjust to the final position by rotating the adjustment knob, and press parts into place. Unlike conventional presses, the WoodRiver® Deluxe Pen Press allows two ways of pressing the parts together: by using the lever arm to press the parts into place or by leaving the lever arm in the closed position and using the screw arm for the pressing of parts. The steel base provides a solid stable platform from which to work.

154308\$79.99

Pen kits sold separately



Pen Kit Disassembly Tools

Easily repair pen kits, just match the millimeter size of the pen boring you need to disassemble. Includes detailed instructions for use. Not for pencil kits.

125755 for 7mm boring.....\$16.99
125756 for 10mm boring.....\$14.99



WoodRiver® Universal Pen Tube Insertion Tool

Keep the glue where it belongs and not on your fingers with this versatile tube insertion tool that works with pen tubes from 7mm to $37/64$ inch in diameter. After you've applied glue to your blank, slip the pen tube onto the chrome plated shaft and insert the tube into the blank.

151050\$12.99



Novelty Clips For Slim Style Pens

Let you personalize gift pens or create pens for sale to target groups. Each 10+ 25+

149313 football clip, chrome.....
.....\$2.19...\$1.97...\$1.86
149314 football clip, gold
(A).....\$2.19...\$1.97...\$1.86

Pen Blank 5-lb. Grab Bag

Overstock of pen blank seconds (small defects) and pieces that are less than 5" long. Now's your chance to make our "trash" your "treasure"! Filled with over 5-lb. of blanks and blank pieces in a variety of species, (species are not identified).

126048 5-lb. grab bag.....\$38.99



WoodRiver® DV2 Self-Centering Drilling Vise

The unique design of this WoodRiver® DV2 Self-Centering Drilling Vise allows anyone to drill straight, accurate holes for everything from pen blanks to bottle stoppers utilizing any corded or cordless drill. Vertical "V" slots in the vise's jaws secure round or square blanks under your bit, while the jaws clamp firmly and quickly and remain both parallel to each other and square to your drill bit for consistently accurate and repeatable drilling. This jaw design eliminates off-center holes in your pen blanks and increases your production while making a critical pen making process easy. Features include a comfortable T-handled grip, fully adjustable heavy-duty toggle clamp, and a sturdy angled steel base. Just clamp



a pen or bottle stopper blank in the vise, center under your drill bit, and drill away. The vise will remain centered on every subsequent pen blank and bottle stopper up to $1\frac{1}{2}$ " square ($2\frac{3}{16}$ " diagonal). The WoodRiver® DV2 Self-Centering Drilling Vise comes with a set of 7mm, 10mm, $25/64$ ", and $27/64$ " Drilling Guides and Stop Collars. Other sized drilling guides and stop collars sold separately.

158385 WoodRiver® DV2.....\$119.99

Drilling Guide & Stop Collars

158386 7mm\$10.99
158387 10mm\$10.99
158388 10.5mm\$10.99
158389 12.5mm\$10.99
158390 $3/8$ "\$10.99
158391 $25/64$ "\$10.99
158392 $27/64$ "\$10.99
158393 $15/32$ "\$10.99
158394 letter "O"\$10.99

WoodRiver® Deluxe Self-Centering Pen & Bottle Stopper Drilling Vise

The unique design of this vise assures the jaws clamp firmly and quickly, while remaining parallel to each other and square to your drill press table. No more off center holes in your pen blanks! A comfortable T-handled grip handle and a fully adjustable heavy duty toggle clamp ensure easy, secure clamping. The vise jaws have vertical "V" slots so both round and square blanks are held firmly under the drill bit for perfect, repeatable drilling. Just clamp a pen or bottle stopper blank in the vise, center under the drill bit and clamp the vise base to the drill press table. The vise will remain centered on every subsequent pen blank up to $1\frac{1}{2}$ " square, ($2\frac{3}{16}$ " diagonal).

151256\$89.99



Shown with blank mounted



Pen And Pencil Maker's Mandrel

Our economical mandrel system provides is simple to use - simply place the proper bushings and your blanks on the shaft and secure with the knurled brass mandrel nut. When turning projects do not require the full length of the mandrel shaft, just slide the provided stop onto the mandrel at the needed length, and tighten the stop! Includes Morse Taper, shaft, knurled brass shaft nut and compression stop nut.

141468 #1 MT mandrel\$15.50
141469 #2 MT mandrel\$15.29
141502 repl. mandrel shaft.....\$3.99
141503 repl. compression stop nut.....\$1.99
141063 repl. knurled brass nut.....\$2.25

Bushing Sets

150488 .45 caliber pen.....\$7.25
159230 Accord pen\$6.50
147206 Atlas ball point pen.....\$5.99
850047 Bolt action, & mini action pen....\$6.99
857037 Bolt act.ion magnum pen\$6.99
127767 click ball point pen\$9.50
152728 Continental/Kojent ballpt. pen ...\$5.99
160814 Dugas tri-pen\$4.99
144635 El Grande/Cambridge/Churchill...\$7.99
159233 Emperor pen\$6.99
128452 European pen\$9.25
06S62 European style pen\$6.69
123485 European style pencil.....\$9.75
145233 Hart double twist.....\$5.99



WHITESIDE Pro Pen Mandrel #2 MT

Gone are the days of off-centered turnings and the need for spacers for those shorter projects. The Whiteside Pro Pen Mandrel system incorporates similar technology used on today's most modern CNC machines. This technology allows for a superior hold on the mandrel, while providing quick, easy adjustments for the varying lengths of different kits. Simply loosen the collet nut, slide the mandrel to the desired length and retighten; it's that simple! The Whiteside Pro Pen Mandrel also features a precision machined fitting #2 Morse Taper, which promotes a better fit to the taper on the headstock of the lathe. Chuck incorporates a #2 MT and is $5\frac{5}{16}$ " long. Mandrel is .246" in diameter and $7\frac{1}{2}$ " long.

157776\$39.99
159183 replacement shaft.....\$6.99



Professional Pen Turning Mandrel

A totally new concept, our mandrels feature a collet that ensures that the shaft is always exactly centered on your lathe. Because the collet body is hollow, the amount of mandrel shaft extending from the collet can be varied for turning everything from key chains to larger pens. The locking nut and collet work like the collet in your router, just loosen the nut and slide the shaft in or out to the length you need, then tighten. The small end of the collet body features a $5/16$ " thread that allows you to pass a bolt through your headstock and, with the mandrel shaft removed, the collet assembly can be used as a $1/4$ " collet chuck! Includes $1/4$ " collet, collet nut, and mandrel shaft with brass knurled nut.

145998 (A) #1 Morse taper.....\$22.99
145997 (B) #2 Morse taper\$25.99
06R0A replacement shaft/nut.....\$5.99

Sets vary by application see chart, p. 149 - your Woodcraft Store or woodcraft.com for more kits, accessories and full instructions.

159227 Inertia pen.....\$6.50
160834 Lever Action click pen\$4.99
154684 Metro RB/Fnt. pens.....\$8.25
146019 Navigator/Rinehart.....\$7.50
147161 Premier cigar pen, pencil, ultra...\$5.25
153192 Princeton pen.....\$3.99
160161 Revolver click pen.....\$6.25
06R03 slim style pen\$5.99
158494 Tetra pen\$6.99
160810 Turbin BP click pen.....\$4.99
146597 Wall Street II/Puma/Grip\$4.99
147478 Wall St. III/Tropical Island.....\$6.99
161998 Franklin twist pen.....\$4.99
161789 Script click pen\$6.99

WALL STREET II



WoodRiver® Pen Maker's Drill Bits

These HSS precision ground bits start cleanly and limit exit hole chip out. Featuring deep smooth flutes for superior chip extraction and extra sharp lands and flutes that provide precision sized holes with fewer lost blanks. Bits with shanks $\frac{31}{64}$ " and 11mm or larger have shanks reduced to $\frac{7}{16}$ ".

149131 $\frac{5}{16}$ ".....	\$4.50	149137 $\frac{27}{64}$ "...\$10.25
149124 6mm.....	\$3.25	151258 12.5mm \$10.99
149132 $\frac{11}{32}$ ".....	\$6.25	149129 14mm \$11.50
149125 7mm.....	\$5.79	149130 15mm \$11.50
149133 $\frac{3}{8}$ ".....	\$6.79	149135 $\frac{15}{32}$ "...\$11.50
149126 9mm.....	\$7.89	149138 $\frac{31}{64}$ "...\$11.50
149136 $\frac{25}{64}$ ".....	\$8.39	149139 $\frac{33}{64}$ "...\$11.50
149127 10mm...\$8.99		160740 $\frac{11}{16}$ "...\$16.79
149134 $\frac{13}{32}$ ".....	\$8.99	158788 21mm \$15.79
151257 10.5mm \$8.39		149140 ltr. "O"....\$7.89
149128 11mm...\$8.99		

Pen Maker's Bit Set contains the bits required to make the most popular kits. Contains one each 7mm, 10mm, 11mm, $\frac{27}{64}$ ", $\frac{3}{8}$ ", and letter "O" bits.
149141 **Save!**..... \$38.50



WHITESIDE Pen Mills

The Whiteside Pen Mills, feature a sharp, $\frac{3}{4}$ "-diameter carbon steel trimmer head for squaring blanks, and pilot shafts that clean excess glue from inside the brass tubes. Pilot shafts and trimmer heads are sold separately.

The six-piece set includes— $\frac{3}{4}$ " trimmer head and allen wrench with 7mm, 10mm, $\frac{25}{64}$ " and $\frac{27}{64}$ " pilot shafts.

Pilot Shaft	each \$9.99
153193 7mm	161547 .338"
153194* 9mm	153199 $\frac{25}{64}$ "
153195 10mm	153200 $\frac{27}{64}$ "
153196 10.5mm	153201 $\frac{15}{32}$ "
153197 12.5mm	153202 $\frac{31}{64}$ "
161548 $\frac{11}{32}$ "	153203 $\frac{33}{64}$ "
153198 $\frac{3}{8}$ "	153204 letter "O"
161549 letter "V"	
153205 $\frac{3}{4}$ " trimmer head.....	\$12.99
154510 $\frac{3}{4}$ " carbide trimmer head.....	\$19.99
153236 6-piece set Save!	\$39.99

Pen Kits Starter Sets

Getting started turning pen kits has never been simpler. Make your selection from our four styles of pen packages, choose from our wide selection of pen blanks (sold separately), and start turning. Kits are packaged with two pen kits – one gold and one chrome, the proper drill bit, bushings and replacement tubes. Once you have turned both kits, the organizer tray makes a great pen parts storage container. Keep your pen kits, bushings or any small parts organized and secure. Directions included.

- 158356 Wall Street II (shown) \$34.99
- 158357 Cigar..... \$32.99
- 158358 7mm Slimline.....\$26.99
- 158359 European..... \$34.99

Pen Kit Reference Chart

Pen Drill Bits

Kit	Page	Instruction	Hole Size	WoodRiver®	Bushing	Repl. Tubes	Ink Refill
Accord Twist Pen	143	77D65	$\frac{3}{8}$ "	149133	159230	159231	149892/150644/150869
American Pencil	140	77B46	"O"	149140	06R07	123866	N/A
American Slim Pen	140	77A36	7mm	149125	06R03	06R68	06S75, 06S76, 06S77
American Slim Pencil	140	77A36	7mm	149125	06R03	06R78	N/A
Atlas Ball Point Pen	142	77C23	$\frac{3}{8}$ "	149133	147206	147743	149892, 150644, 150869
Bolt Action Pen Magnum	146	N/A	10mm	149127	857037	159239	149892/150644/150869
Bolt Action Pen	146	N/A	$\frac{3}{8}$ "	149133	850047	857409	149892/150644/150869
Bolt Action Pen Mini	146	N/A	$\frac{3}{8}$ "	149133	850047	859230	159326
.45 Caliber Click Pen	141	77D70	10mm	149127	150488	150489	149892/150644/150869
Cartridge Bullet Pen	142	77C73	$\frac{25}{64}$ "	149136	150488	150489	149892, 150644, 150860
Chopper Ballpoint Pen NEW!	142	77E02	10mm	149127	162276	162277	149892,150644,150869
Cigar/Ultra Cigar Pen/Hybrid	143	77C21	10mm	149127	147161	147568	149892, 150644, 150869
Cigar Pencil	143	77C22	10mm	149127	147161	147568	N/A
Click Ball Point Pen	142	77B33	"O"	149140	127767	06S28	149892, 150644, 150869
Continental /Kojent Ballpoint Pen	144	77D22, 77D72	10.5 & 12.5mm	151257, 151258	152728	154333	149892, 150644, 150869
Dugas Tri-Funktion Pen	143	77D87	12.5mm	151258	160814	160813	159326
El Grande Fountain/Rollerball Pen	woodcraft.com	77B91	$\frac{31}{64}$ ", $\frac{33}{64}$ "	149138, 149139	144635	145047	N/A
Emperor Twist Pen	142	77D64	$\frac{11}{32}$ "	149132	159233	159234	149892/150644/150869
European Pen	140	77B04	7mm	149125	06S62	06S53	06S75, 06S77
European Pencil	140	77A78	$\frac{11}{32}$ "	149132	123485	123917	N/A
European Roller Clip Pen	142	77B04	7mm	149125	06S62	06S53	149892, 150644, 150869
Franklin Twist Pen	144	77B48	$\frac{25}{64}$ "	149135	161998	161997	149892, 150644, 150869
Hart Double Twist Pen	142	77B98	"O"	149140	145233	149160	149892
Inertia Pen W/Stylus	144	77D63	"V"	159327	159227	159228	159326
Kaleidoscope Twist Blpnt. NEW!	144	77E01	"O"	149140	162307	162308	159326
Lever Action Pen	141	77D84	10mm	149127	160834	160833	149892, 150644, 150869
Navigator Screw Cap Pen	142	77C05	$\frac{25}{64}$ ", $\frac{15}{32}$ "	149136, 149135	146019	147952	149893
Princeton Pen	142	77D18	$\frac{27}{64}$ "	149136	153192	147120	149892, 150644, 150869
Pluma Twist Pen	143	77D49	$\frac{27}{64}$ "	149137	146597	158630	149892/150644/150869
Revolver Pen	143	77D74	10mm	149127	160161	160153	159326
Script Click Ballpoint Pen	143	77D94	10mm	149127	161789	161788	149892, 150644, 150869
The Rinehart Ballpoint Pen	woodcraft.com	77C81	$\frac{25}{64}$ ", $\frac{15}{32}$ "	149136, 149135	146019	147952	149893
The Rinehart Fountain Pen	woodcraft.com	77D73	$\frac{25}{64}$ ", $\frac{15}{32}$ "	149136, 149135	146019	147952	N/A
The Rinehart Rollerball Pen	woodcraft.com	77C81	$\frac{25}{64}$ ", $\frac{15}{32}$ "	149136, 149135	146019	147952	149893
Sedona Screw Cap Rollerball Pen	142	77C56	$\frac{25}{64}$ ", $\frac{15}{32}$ "	149136, 149135	146019	147952	149893
Slim Style Pen/Stylus Pen	140, 143	77A36	7mm	149125	06R03	06R68	06S75, 06S77
Slim Style Pencil	140	77A36	7mm	149125	06R03	06R78	N/A
Soft Grip Stylus Pen	woodcraft.com	77D47	7mm	149125	158292	06R68	N/A
Stubby Stylus Pen	woodcraft.com	77D21	7mm	149125	06R03	06R68	N/A
Teacher's Pen	142	77C59	7mm	149125	06R03	149925	149850
Tetra Nano Silver Stylus Pen	woodcraft.com	77D48	"O"	149140	158494	158495	149892/150644/150869
Turbin Stylus Pen	142	77D86	"O"	149140	160810	160809	149892/150644/150869
Wall Street II Click & Elegant Pen	141	77C52	$\frac{27}{64}$ "	149137	146597	149280	149892, 150644, 150869
Wall Street II Grip Pen	141	77D85	$\frac{27}{64}$ "	149137	146597	161243	149892, 150644, 150869
Wall Street II Pen	141	77C09	$\frac{27}{64}$ "	149137	146597	147120	149892, 150644, 150869
Wall Street II Pencil	141	77C61	$\frac{27}{64}$ "	149137	146597	150290	N/A
Wall Street II Pen w/Stylus	141	77D20	$\frac{27}{64}$ "	149137	146597	147120	149892, 150644, 150869
Wall Street III Pen	141	77C67	$\frac{27}{64}$ "	149137	147478	147120	149892, 150644, 150869
Wrench Click Ballpoint Pen NEW!	144	77D99	$\frac{3}{8}$"	149133	162267	162303	149892,150644,150869
Woodworker's/Artist's Pencil	142	77C13	$\frac{15}{32}$ "	149135	146768	149725	146769, 146770, 147263





FastCap Quad Edgeband Trimmer

Features a unique pneumatic system for super smooth action. Extra sharp carbon steel blades trims both sides at once, and in either direction. Colors may vary.

836877\$29.25
836876 repl. carbon steel blades.. \$12.99

SAUERS Veneer Sheets And Edging Banding Real wood veneers are ideal for any project including repairing furniture, facing kitchen cabinets, or finishing shelves. Made of the finest select woods, Veneer Sheets are 1/42" thick and backed with 10 mil paper. They should be applied to surfaces using any quality contact cement. Edge Banding is precoated with a heat activated glue for a permanent bond. Just iron it on! Veneers come presanded and ready for finishing. Includes instructions. 3M PSA backed is real wood veneer permanently bonded to 3M pressure sensitive adhesive. These 1/64" thick veneers are bonded to a 2mil backing.

	7/8" x 25'	7/8" x 50'	7/8" x 250'	2" x 25'	2" x 50'	1' x 8'	1' x 8' PSA	2' x 8'	2' x 8' PSA	4' x 8'		
Species	\$10.29	\$10.89	\$16.49	\$39.39	\$19.59	\$29.39	\$33.99	\$48.99	\$51.99	\$81.50	\$77.50	\$89.50
birch, white	147423	147423	835186	147425	835187							
cherry	147426	147427	835199	147428		153270		131530	153282		404162	
maple	147432	147433	835195	147434		153273	153279	131532	153285		404182	
oak, red	147435	147436	835196	147437		153274	153280	131533	153286	404192		
oak, white	147438	147439	836678	\$20.59	147440			\$52.50	\$83.50		\$89.99	
mahogany	147441	147442		\$19.59	147443	153272	153278	131531	153284		404177	
				\$18.59	\$21.89							\$117.99
walnut	147447	147448	835500	147449		153275	153281	131534				404201
melamine				\$15.49	\$33.49	\$18.59						
white	147450	147451	836679	859363								
				\$20.59	\$20.59							
black	147452	147453		859362								
						Flat Cut						
						3M PSA		10 mil			10 mil	
teak	147444	147445		\$24.09	\$24.09			\$89.99			\$164.99	
				147446				404138			404199	



Thin Stock Hardwood Packs

Offered in convenient packs of 2 sq. ft. with random widths (3" to 9"), all with a 24" nominal length. Rough sanded and ready for use.

- 827943 bubinga, 1/8" thick.....\$23.99
- 827932 bubinga, 1/4" thick.....\$27.29
- 827921 bubinga, 1/2" thick.....\$38.59
- 827948 cherry, 1/8" thick.....\$23.99
- 827937 cherry, 1/4" thick.....\$27.29
- 827926 cherry, 1/2" thick.....\$39.79
- 827941 mahogany, African, 1/8" thick....\$25.29
- 827930 mahogany, African, 1/4" thick....\$28.59
- 827949 maple, hard 1/8" thick.....\$23.99
- 827938 maple, hard, 1/4" thick.....\$27.29
- 827927 maple, hard, 1/2" thick.....\$39.79
- 827942 padauk, 1/8" thick.....\$24.99
- 827931 padauk, 1/4" thick.....\$28.39
- 827920 padauk, 1/2" thick.....\$35.19
- 827947 purpleheart, 1/8" thick.....\$25.29
- 827936 purpleheart, 1/4" thick.....\$28.39
- 827925 purpleheart, 1/2" thick.....\$39.79
- 827950 walnut, 1/8" thick.....\$24.99
- 827939 walnut, 1/4" thick.....\$28.39
- 827928 walnut, 1/2" thick.....\$39.79
- 828197 yellowheart, 1/8" thick.....\$24.99
- 828198 yellowheart, 1/4" thick.....\$27.29
- 828199 yellowheart, 1/2" thick.....\$37.79



SAUERS Craftsman Veneer Packs

High quality real wood veneers from around the world. Each pack contains 3 square feet of unbacked veneer that ranges from 4 1/2" to 6 1/2" in width by 12" in length. All packs are sequence matched (cut in sequence from the same piece of wood). You may have more than one sequence in a pack, but rarely more than two.

- 131379 anegre\$11.50
- 131377 ash, burl.....\$19.99
- 131389 beech.....\$11.75
- 853017 blue.....\$26.50
- 131392 bubinga.....\$11.75
- 153152 bubinga, waterfall.....\$24.50
- 147930 cedar, spanish.....\$11.99
- 158809 cherry.....\$9.99
- 131381 ebony.....\$31.50
- 131380 lacewood.....\$13.25
- 131536 mahogany.....\$10.99
- 131376 mahogany, crotch.....\$36.99

SAUERS Large Veneer Packs

Twelve square foot packs of solid wood veneer for larger projects. Packs are comprised of sequence matched veneers 48" in length and 4 1/2" to 6 1/2" in width. All pieces of veneer in a pack will be the same width. Grain runs lengthwise.

- 131450 birch.....\$22.50
- 147932 cedar, spanish.....\$28.99
- 131440 cherry.....\$21.50
- 131444 lacewood.....\$41.99
- 131443 mahogany.....\$24.99
- 131446 maple.....\$20.99
- 147931 maple, birdseye.....\$86.50
- 131447 maple, figured.....\$44.99
- 131445 oak, flaky.....\$21.50

- 158814 maple.....\$10.19
- 131375 maple, birdseye.....\$23.50
- 131378 maple, burl.....\$34.99
- 131384 maple, figured.....\$13.99
- 131512 maple, quilted.....\$34.99
- 131438 oak, flaky.....\$9.75
- 158808 oak, red.....\$9.99
- 832568 padauk.....\$14.50
- 131390 purpleheart.....\$14.50
- 131510 redwood, burl.....\$34.99
- 131386 rosewood.....\$29.99
- 131383 sapele.....\$10.25
- 131535 walnut.....\$11.50
- 131387 walnut, burl.....\$35.99
- 131391 wenge.....\$14.99
- 131382 zebrawood.....\$15.50
- 131537 domestic assortment pack.....\$13.50

Dyed Veneers Each pack contains 3 square feet of unbacked veneer that ranges in size from 4 1/2" to 6 1/2" in width by 12" in length. The *Base Color Assortment* contains red, green, blue, white, black and yellow, the *Wild Color Assortment* varies based by package, but generally includes colors like pink, purple, orange, grey, etc.

- 131394 black dyed.....\$23.50
- 131395 white dyed.....\$23.50
- 832569 red dyed.....\$22.99
- 131396 base color asst.....\$28.25
- 131397 wild color asst.....\$28.25
- 131437 dyed mixed greens asst.....\$27.99



- 131442 oak, red.....\$21.50
- 131448 oak, white.....\$20.99
- 131449 pine.....\$22.75
- 131441 walnut.....\$23.99
- 158881 dom. assort. pk., 12 sq. ft.\$30.25

WoodRiver® Veneer

Edge Banding Iron

The perfect tool for applying heat-activated, pre-glued edge banding with thermostatic heat control (100°-350°F), non-stick coating, 5 1/2' power cord, 110V.

144952\$41.99

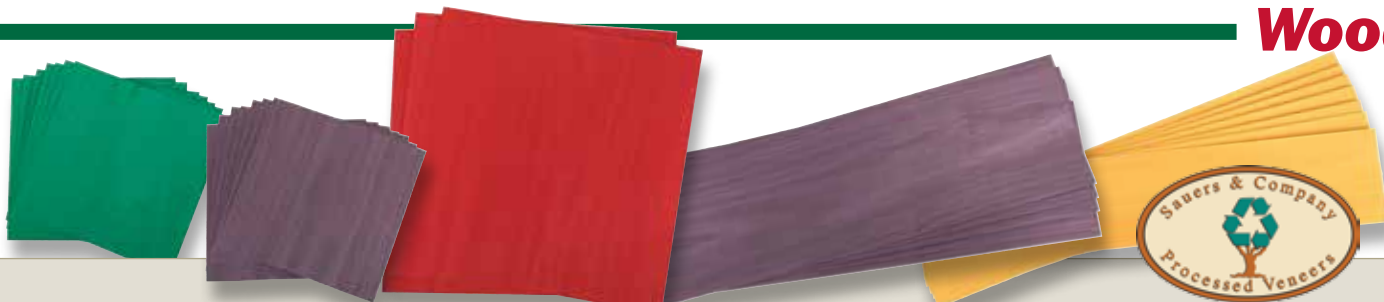

SAUERS Dyed Wood Veneer Packs

Dyed Wood Veneer by Sauers & Co. packaged in a convenient size that won't break your budget!

All of the dyed veneers that we work with have been bleached first and then pressure cooked with dye to saturate completely through every wood fiber. This is done to reduce fading and any possibility of sanding through the color. This dying process is done in Italy. These dyed veneers could include Maple, Birch, Poplar, Tay, Koto or any American white wood.

These vibrant colors add quite a bit to your project without extensive finishing experience. No matter what you use them for, you'll be delighted with the result you get with this all Natural Wood Veneer by Sauers & Co.

Each pack contains 7 pieces of 8" x 8" unbacked, high-quality real wood veneer.

Dyed Veneer 8" x 8", 7 pieces

Black Dyed Veneer	161062\$23.99
Lime Green Dyed Veneer	161063\$23.99

Navy Blue Dyed Veneer	161064\$23.99
Orange Dyed Veneer	161065\$23.99
Purple Dyed Veneer	161066\$23.99
Red Dyed Veneer	161067\$23.99
White Dyed Veneer	161068\$23.99
Yellow Dyed Veneer	161069\$23.99

Each pack contains 3 pieces of 12" x 12" unbacked veneer.

Dyed Veneer 12" x 12", 3 pieces

Black Dyed Veneer	161075\$26.99
Lime Green Dyed Veneer	161076\$26.99
Navy Blue Dyed Veneer	161077\$26.99

Orange Dyed Veneer	161078\$26.99
Purple Dyed Veneer	161079\$26.99
Red Dyed Veneer	161080\$26.99
White Dyed Veneer	161081\$26.99
Yellow Dyed Veneer	161082\$26.99

Each pack contains 4 square feet, 8" to 12" in width 24" in length. All pieces in the pack will be the same size, unbacked high-quality real wood veneer.

Lime Green Dyed Veneer, 4 sq. ft.	161087\$39.99
Orange Dyed Veneer	161088\$39.99
Purple Dyed Veneer	161089\$39.99

Each pack contains 6 square feet Sequenced Matched - 4 1/2" to 7 1/2" wide x 25" long. All pieces in the pack will be the same size unbacked, high-quality real wood dyed veneer.

Black Dyed Veneer, 6 sq. ft.	161090\$46.99
Lime Green Dyed Veneer	161091\$46.99
Navy Blue Dyed Veneer	161092\$46.99
Orange Dyed Veneer	161093\$46.99
Purple Dyed Veneer	161094\$46.99
Red Dyed Veneer	161095\$46.99
White Dyed Veneer	161096\$46.99
Yellow Dyed Veneer	161097\$46.99
Dyed Veneer assortment	162241\$49.99

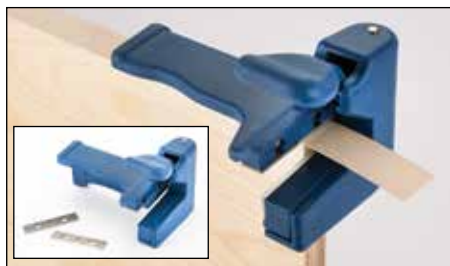

WoodRiver® Edge Banding End Trimmer

Cut perfectly clean veneer, melamine and PVC with this WoodRiver® Edge Band Trimmer. It features razor-sharp steel blades that will cut strips up to 0.5mm thick and 2" wide. Comes with a set of replacement blades.

159651\$29.99

WoodRiver® Double-Edge Laminate Trimmer

Our Double-Edge Trimmer easily and smoothly trims veneer and laminate on both sides of your work in one operation. It is capable of handling boards from 1/2" to 1" thick. A second cutter behind the first can be adjusted to give a beveled edge. The body is plastic, and the blades are high-carbon tool steel and can be easily re-honed or replaced when dull.

157450 trimmer\$17.00
157401 repl. blades\$7.50



20 Mil Vinyl Replacement Vacuum Bag With Zip Closure

Vacuum bags in 20 mil vinyl. Generally speaking, vinyl is fine for flat or modestly curved work and for infrequent use. Vinyl is economical.

828928 24" x 36" D/S \$74.99
826879 36" x 54" D/S \$105.99



MILESCRAFT® 8403 Laminate Trimmer™

LaminateTrimmer™ has a sleek design, allowing you close control when trimming away laminate, edge banding and veneer. In addition to straight edges, the LaminateTrimmer also works well on round surfaces, and the tool's versatile design allows you to use it from both sides. No matter the size of your hands, the trimmer has a great fit, giving you full control while cutting. The LaminateTrimmer uses a standard razor blade, which makes replacement easy – no specialty blades required!

158930\$5.99



WoodRiver® Vacuum Pump Kit

Vacuum clamping ensures that even pressure is exerted over the entire surface area of the work. Ideal for use when forming too, this kit comes with 2' x 2' vacuum bag. The 1/8 HP pump runs quietly and will draw all the air out of the largest bag very quickly. Mounted on four anti-vibration rubber feet, the pump is small enough to sit on the bench, and a carry handle makes it easy to transport. The supplied polyurethane hose is sturdy and hardwearing and simply clips on to the pump. An in-line filter ensures that dust and debris are not drawn into the pump from the bags. The thick vinyl bags feature full width airtight closures for easy access in and out of the bag. The heavy-duty single-track zipper closure ensures that, once sealed, air cannot enter the bag. For ease of use, five spring clamps are included to help when folding the bag to a smaller size. This high pressure vacuum clamping system is ideal for anyone who does a lot of veneering or wood forming.

159773\$299.99

D/S = Item drop ships direct from manufacturer.



4-Way Match Veneer Packs

These sequence cut, 4-way matched veneers are perfect for many common projects. The 4-way match allows them to be used end to end for projects such as drawer fronts, side by side for panels, and end to end or side by side for larger projects. Premium figured woods are 0.025" (1/40") thick. Each pack contains 4 sq. ft. of veneer in (4) 8" x 18" sheets.

- 151076 (A) birds eye maple \$40.50
- 151077 (B) maple burl..... \$54.25
- 846959 mappa burl..... \$37.99
- 846960 redwood burl..... \$49.99
- 151080 (C) walnut burl \$51.99
- 151081 (D) mahogany crotch \$51.99

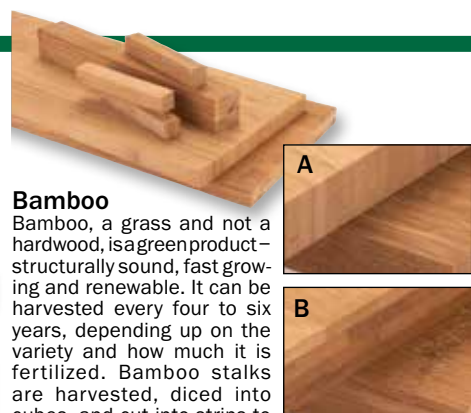

Bamboo

Bamboo, a grass and not a hardwood, is a green product—structurally sound, fast growing and renewable. It can be harvested every four to six years, depending up on the variety and how much it is fertilized. Bamboo stalks are harvested, diced into cubes, and cut into strips to the length needed. These strips are processed by boiling and bug proofing and then laid up into boards, flooring and plywood. The bamboo types you will see on the market are: vertical and horizontal (sometimes called flat). Vertical Bamboo has sides in a vertical fashion, and the nodes (growth rings) tend to show up as little eyes similar to the spots in birds-eye maple. Horizontal has all the strips lying flat so that you see the nodes, and it has a more striking Bamboo appearance. Bamboo blanks are carbonized (sometimes called caramelized) by heating them. Most carbonized Bamboo will be a medium brown, while other Bamboo on the market is natural, a blondish, honey color.

- 158366 3/4" x 3/4" x 5' (5-pc.)..... \$9.19
- 158363 (A) 3/4" x 8" x 30" Vert. grain..... \$31.19
- 158364 (B) 3/4" x 8" x 30" Horiz. grain..... \$31.19
- 158365 1 1/2" x 1 1/2" x 12"..... \$7.39

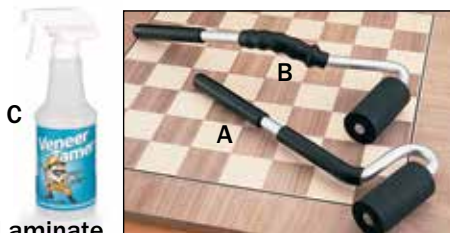

Laminate and Veneer Rollers

Evenly adheres even the most obstinate laminates and veneers. The Standard "J" Roller features a 1 1/2" dia. x 3" wide non-marring rubber roller with a 10" long handle and vinyl grip. The Heavy Pressure Roller features a slight bend in the steel handle to provide extra leverage and pressure. 14 3/4" long with two vinyl grips.

- 129841 (A) standard "J" roller \$15.99
- 129842 (B) heavy pressure roller \$22.99

Veneer Scraper

- 153634 \$14.99

Veneer Tamer

- 153633 (C) \$12.99

Veneer Tape

- 153092 2-hole, 3/4" x 650' \$11.99
- 153093 no-hole, 3/4" x 650' \$11.99



Red Wine Barrel Staves, 3-piece

These Oak Barrel Staves come from a used red wine barrel, which was stained by the red wine. Wine is stored for one to two years and leaves a very subtle aroma in the staves. Barrel staves are 36"-37" long, and this pack contains three staves: one small (1 1/2"-2 1/2" wide), one medium (2 1/2"-3 1/2" wide) and one large (3 1/2" and wider). Staves have been dried and brushed to remove excess residue. They are, of course, bent from barrel making, but they can be flattened by simply soaking them in warm water and then clamping to your workbench for several hours. Staves are perfect for projects ranging from Adirondack chairs and benches to small boxes and accent pieces.

- 160197 \$26.59

Wood Identification & Use Compact Edition

By Terry Porter. Every feature of more than 200 wood species, illustrated and described with working properties, seasoning requirements, durability, decorative figuring, information on defects, potential health hazards, and an enlarged glossary. 288 pgs., soft cover.

- 853966 \$24.95

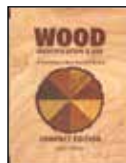

Domestic Handle Stock 4-piece Combo Pack 2" x 2" x 6"



We have gone to the well one more time and asked our wood sources to find us a first-rate deal. This is the time of year that turners are making gifts, and this low-cost collection of Cherry, Walnut, Maple and Ash is perfect for making pizza cutters, ice cream scoops, and other handled items. At this price the pack also provides great practice stock.

- 159504 \$11.99

Veneer Sample Pack

Includes fifty 4" x 9" veneer samples, everything from ash to zebrawood. An excellent resource for choosing woods for future projects, testing finishes, or teaching. Includes a listing of species, botanical names and country of origin.

- 15W12 \$44.99



Hardwood Dowels

Select from the finest quality, 36" long, straight-grained dowels that are smooth sanded. Buy any 10 dowels and you can deduct 10% of their total cost! Buy any 50 and deduct 15%!
Note: Minimum order for dowels is \$5.00. Choose round or square dowels.

Birch		Cherry		Maple		Mahogany		Oak		Walnut	
848487	1/8" rnd. \$0.89	50B01	1/4" rnd. \$3.69	158592	1/4" rnd. \$2.50	158608	1/4" rnd. \$4.79	50A01	1/4" rnd. \$1.79	50C01	1/4" rnd. \$3.75
848488	3/16" rnd. \$0.99	50B02	3/8" rnd. \$4.99	158593	3/8" rnd. \$2.50	158609	3/8" rnd. \$6.25	50A02	3/8" rnd. \$3.99	50C02	3/8" rnd. \$4.99
50D01	1/4" rnd. \$1.25	50B03	1/2" rnd. \$6.19	158594	1/2" rnd. \$3.69	158610	1/2" rnd. \$7.19	50A03	1/2" rnd. \$3.25	50C03	1/2" rnd. \$5.75
848489	5/16" rnd. \$1.19	852475	5/8" rnd. \$7.50	158595	5/8" rnd. \$4.19	158611	5/8" rnd. \$9.75	852473	5/8" rnd. \$4.69	852474	5/8" rnd. \$8.15
50D02	3/8" rnd. \$1.29	50B04	3/4" rnd. \$7.99	158596	3/4" rnd. \$6.50	158612	3/4" rnd. \$12.39	50A04	3/4" rnd. \$6.29	50C04	3/4" rnd. \$9.59
852470	7/16" rnd. \$1.69	158605	7/8" rnd. \$11.25	158617	7/8" rnd. \$7.80	158613	7/8" rnd. \$15.09	158589	7/8" rnd. \$6.79	158602	7/8" rnd. \$12.50
50D03	1/2" rnd. \$1.89	50B05	1" rnd. \$11.39	158597	1" rnd. \$9.10	158614	1" rnd. \$21.50	50A05	1" rnd. \$6.99	50C05	1" rnd. \$12.99
848490	5/8" rnd. \$2.69	158606	1 1/8" rnd. \$15.50	158598	1 1/8" rnd. \$10.65	158616	1 1/4" rnd. \$25.79	158590	1 1/8" rnd. \$10.70	158603	1 1/8" rnd. \$19.25
50D04	3/4" rnd. \$3.59	158607	1 1/4" rnd. \$19.99	158599	1 1/4" rnd. \$11.85			158591	1 1/4" rnd. \$13.99	158604	1 1/4" rnd. \$21.50
852471	7/8" rnd. \$4.69	851132	1/4" sq. \$4.99	50D07	1 1/2" rnd. \$13.99			851128	1/4" sq. \$1.79	851137	1/4" sq. \$4.99
50D05	1" rnd. \$6.19	851133	3/8" sq. \$5.99	158600	1 3/4" rnd. \$18.99			851129	3/8" sq. \$2.59	851138	3/8" sq. \$6.79
852472	1 1/8" rnd. \$7.29	851134	1/2" sq. \$7.19	158601	2" rnd. \$19.75			851130	1/2" sq. \$3.49	851139	1/2" sq. \$8.60
50D06	1 1/4" rnd. \$9.10	851135	3/4" sq. \$12.39	851141	1/4" sq. \$1.99			851131	3/4" sq. \$6.50	851140	3/4" sq. \$13.99
				851142	3/8" sq. \$3.19						
				851143	1/2" sq. \$3.69						
				851144	3/4" sq. \$6.89						



A	B	C	D	E	F	G	H	I	J	K	L	M	N	O	P	Q	R	S	T	U	V	W	X	Y	Z																																																		
Premium Inlay Bandings ACTUAL SIZE																																																																											
These premium inlay bandings are chosen by the demanding professionals to add a distinctive touch to furniture, boxes, and restoration pieces. Quality construction aids installation and reduces time in the finish room. Installation is easy: Simply rout a groove to the proper width and depth with a straight cut router bit and glue the banding in place. Made in the USA from domestic and exotic woods, in your choice of widths from 1/8" to 1/2" wide, 36" long, approximately 1/28" (0.035)" thickness.																																																																											
149601	#001, 2 pcs., 1/8"	A	\$6.69	149609	#009, 2 pcs., 3/16"	Ⓞ	\$23.69	149610	#010, 2 pcs., 3/16"	Ⓟ	\$11.79	149611	#011, 2 pcs., 1/4"	K	\$22.59	149612	#012, 2 pcs., 1/4"	L	\$23.19	149613	#013, 2 pcs., 1/4"	M	\$23.19	149614	#014, 2 pcs., 1/4"	N	\$27.29	149615	#015, 2 pcs., 1/4"	O	\$30.39	149616	#016, 2 pcs., 1/4"	Ⓠ	\$23.19	149617	#017, 2 pcs., 1/4"	Q	\$28.79	149618	#018, 2 pcs., 1/4"	R	\$23.19	149619	#019, 2 pcs., 5/16"	S	\$16.69	149620	#020, 2 pcs., 5/16"	T	\$27.29	149621	#021, 2 pcs., 5/16"	U	\$29.39	149622	#022, 2 pcs., 5/16"	V	\$25.19	149623	#023, 2 pcs., 5/16"	W	\$29.39	149624	#024, 2 pcs., 3/8"	X	\$24.69	149625	#025, 2 pcs., 3/8"	Y	\$26.29	149626	#026, 2 pcs., 3/8"	Z	\$32.89



149627	#027, 2 pcs., 1/2"	AA	\$26.79
149628	#028, 2 pcs., 1/2"	BB	\$32.89
149629	#029, 2 pcs., 1/2"	CC	\$24.49



Finnish Birch Plywood

This 100% Finnish Birch multi-ply plywood is lightweight, yet has superior strength and durability characteristics which make it useful for a variety of woodworking applications. The "front" face is classified as paint grade, slight variation in color is acceptable, but no patches are allowed. The "rear" face and inner plies may contain patches. Both faces are sanded smooth. Exterior glue is used so this plywood can even be used for outdoor projects (with an appropriate outdoor finish). 5/32" has 3 plies, 1/4" has 5 plies, 3/8" has 7, the 1/2" has 9 and the 3/4" has 14 plies. All sizes are nominal - grain runs with largest dimension, overall size may vary ±1/4".

	T x W x L	Per Sheet	6+ Sheets
124878	5/32" x 12" x 30"	\$19.99	\$17.99
124879	5/32" x 24" x 30"	\$24.99	\$22.49
50Y01	1/4" x 12" x 30"	\$25.99	\$23.39
50Y02	1/4" x 24" x 30"	\$30.99	\$27.89
50Y05	1/2" x 12" x 30"	\$21.50	\$19.35
50Y06	1/2" x 24" x 30"	\$36.99	\$33.29

Micro-Thin Birch Plywood has cabinet grade faces on both sides (no patches or plugs). Made with water resistant glue for protected exterior use. Aircraft quality for the most demanding projects. GL2 rated but not certified and has the most accurate thickness tolerances of +/- .002".

	T x W x L	Per Sheet	6+ Sheets
50W18	1/16" x 6" x 12"	\$9.99	\$8.99
50W22	1/16" x 12" x 24"	\$21.50	\$19.35
50W23	1/8" x 12" x 24"	\$26.99	\$24.29
159908	.4mm - 1/64" x 30" x 30"	ea.	\$24.99
159910	1.0mm - 1/32" x 30" x 30"	ea.	\$34.99



Baltic Birch Plywood

Baltic Birch, aka 'Russian Birch', is a popular panel best known for its light color, strength, multi-ply construction, and affordable cost. Our sheets are graded as B/BB (or 3-B) and is the very best grade available. This means that one face, B, will be a whole natural wood surface, no splices, have no patches (plugs that are used to cover defects) but may contain knot pattern or mineral streaks. Suitable for staining or painting. The other face, BB, and the inner plies will contain patches and tight, and not so tight knots. The best grades of Baltic birch plywood offer the quality necessary for the construction of fine cabinetry. In addition, Baltic Birch Plywood is an excellent material for drawer sides and bottoms, skateboards, as well as jigs and fixtures, and scroll saw work. All sizes are nominal - grain runs with largest dimension, overall size may vary ±1/4".

131138	1/8" (3mm) x 12" x 12"	\$1.99
131405	1/8" (3mm) x 12" x 30"	\$6.50
131400	1/8" (3mm) x 24" x 30"	\$8.99
152980	3/8" (9mm) x 30" x 48"	\$18.50
131139	1/4" (6mm) x 12" x 12"	\$2.75
131406	1/4" (6mm) x 12" x 30"	\$6.99
131401	1/4" (6mm) x 24" x 30"	\$10.50
152979	1/4" (6mm) x 30" x 48"	\$21.25
131140	3/8" (9mm) x 12" x 12"	\$3.75
131407	3/8" (9mm) x 12" x 30"	\$8.99
131402	3/8" (9mm) x 24" x 30"	\$13.50
152978	3/8" (9mm) x 30" x 48"	\$26.99
131141	1/2" (12mm) x 12" x 12"	\$3.99
131408	1/2" (12mm) x 12" x 30"	\$9.99
131403	1/2" (12mm) x 24" x 30"	\$16.50
152977	1/2" (12mm) x 30" x 48"	\$39.99
131142	3/4" (18mm) x 12" x 12"	\$4.25
131409	3/4" (18mm) x 12" x 30"	\$14.99
131404	3/4" (18mm) x 24" x 30"	\$21.75
152976	3/4" (18mm) x 30" x 48"	\$49.99



Phenolic face color may vary

Phenolic Faced Multi-Ply

This manufactured material is fantastic for shop-built auxiliary tables, fences, jigs and fixtures. It is dimensionally stable and has protective surfaces that will stand up to the harsh wear and tear of your woodworking shop. Phenolic Faced Multi-Ply can be machined with standard woodworking tools and holds screws well. Sheets are 24" x 48", ±1/4", with face grain running with the longest dimension. Phenolic face color may vary.

153884	1/2" x 24" x 32"	\$41.99
131171	1/2" x 24" x 48"	\$54.99
153883	3/4" x 24" x 32"	\$51.50
131170	3/4" x 24" x 48"	\$69.99

TITEBOND Cold Press Glue For Veneer

Titebond Cold Press glue is a high-quality, economical alternative to contact cement for veneering flat surfaces. Specifically formulated for cold press laminating of wood to solid woods, particleboard, MDF, plywood and other porous materials, it offers a translucent glue line and no harmful or corrosive fumes. It also prevents bleed-through on open-grained and non-backed wood veneers. Set time is usually 15 minutes at room temperature, allow 24 hours for full cure.



145718	quart	\$10.99
825575	gallon	\$25.99

159908



Pentacryl Wood Stabilizer

Pentacryl combats the negative effects of drying by displacing water and moisture in wood fibers. This non-toxic solution doesn't stain the wood or affect finishing in any manner. The recommended method of application is total immersion, but the product can also be brushed or sprayed.



- 129318 quart (shown).....\$20.99
129319 gallon.....\$62.99

Wood Knife Scales

Woodcraft has brought together the most exceptional stock of domestic and exotic hardwood knife scale blanks, either 1" thick solid stock or matching 3/8" pieces. Each piece is selected for its striking figure, and blanks are milled to sizes that make the knife making process easy and efficient with minimal waste.



Finished Kit
161198 using
Beeswing Narra
for handle

- 3/8" x 1 1/2" x 5", 2 pieces
- 153750 amazakoue.....\$8.25
159049 amboyna burl.....\$41.19
131584 bocote.....\$9.29
154606 bubinga.....\$4.50
154607 cherry.....\$4.25
160088 ebony, Gaboon.....\$12.99
148865 ebony, Macassar.....\$20.50
159718 ironwood, Suriname.....\$9.29
159376 kiaat.....\$8.25
154608 maple.....\$4.25
153746 olivewood.....\$13.09
159482 padauk.....\$7.25
160090 palm, red.....\$9.79
160091 palm, black.....\$7.25
159382 pink ivory.....\$15.39
154605 purpleheart.....\$4.25
160086 purpleheart, figured.....\$8.25
131582 rosewood, Bolivian.....\$5.75
160089 rosewood, Burmese.....\$8.99
153752 rosewood, Honduran.....\$14.89
160087 satinwood, figured.....\$11.25
159386 walnut, Peruvian.....\$7.50
153742 wenge.....\$8.25
153740 zebrawood.....\$8.25

- 1" x 1 1/2" x 5", 1 piece
- 153762 blackwood African.....\$11.29
153760 blackwood Burmese.....\$7.50
131583 cocobolo.....\$15.99
153758 ebony, black & white.....\$17.50
159380 maple, curly.....\$8.99
154604 marblewood.....\$6.19
152891 snakewood.....\$32.19



Banksia Pod

These pods feature hard and solid seed pod cavities that run from the outside toward the center core and are useful for making ornamental objects.

- Medium size pods average 7" L x 3" D.
148745..... each \$13.50

Hardwood Pen Blank

Woodcraft has brought together the most exceptional variety of domestic and exotic hardwood pen blank stock, milled to sizes that make the pen turning process easy and efficient with minimal waste. These striking examples of the world's most beautiful woods lend themselves perfectly to pen making. Don't be afraid to try something new!

Black &
White
Ebony



- 3/4" x 3/4" x 5", 5-pieces
- 160173 angelique.....\$3.09
152937 ash.....\$4.09
153338 blackwood, Burmese, diag. cut \$13.29
838476 blackwood, African.....\$17.39
152952 bloodwood.....\$11.49
152938 bocote.....\$12.29
152940 bubinga.....\$8.19
154394 camelthorn.....\$11.29
152953 cherry.....\$6.19
152939 cherry, Brazilian.....\$7.39
152941 cocobolo.....\$10.19
146529 ebony, black and white (shown) \$20.39
838480 ebony, gaboon.....\$25.49
152943 ebony, Macassar.....\$13.29
152879 holly, American.....\$11.49
152944 kingwood.....\$17.39
158743 lignum vitae.....\$17.39
149695 maple, birds-eye.....\$10.19
152942 maple, curly.....\$7.69
838487 olivewood.....\$12.29
160079 olivewood, Roman.....\$13.29
152947 padauk.....\$9.49
153011 palm, black.....\$16.39
154400 pau rosa.....\$12.99
838488 pink ivory.....\$13.29
152948 purpleheart.....\$14.29



Stopper or Pen Kit
sold separately



Briar Wood Blanks

Briar root, the burlwood of the Heath Tree, is also known as French bruyère. It is an extremely hard and heat-resistant wood traditionally used for making smoking pipes. The football-sized burls are harvested at the age of 30 to 60 years and then cooked for several hours, after which they are dried for several months before they are further processed. The wood is light brown to reddish brown, often beautifully textured, very hard, and heat-resistant, which does not affect the aroma of pipe tobacco smoke. The wood is also used for making jewelry and knife handles. Blanks are a nominal 1 1/2" x 2 1/8" x 3" in size.

- 159418 (A) straight.....\$20.99
159419 (B) bent.....\$20.99

- 846376 redheart.....\$8.19
161518 rosewood, African.....\$7.19
838477 rosewood, Bolivian.....\$9.19
153022 rosewood, Burmese.....\$8.19
153337 rosewood, Burmese, diag. cut \$14.59
838479 rosewood, East Indian.....\$11.50
154398 tamboti.....\$10.19
152949 walnut.....\$9.19
152950 wenge.....\$10.19
153013 zebrawood.....\$9.19
153335 zebrawood, diagonal cut.....\$15.99

- 3/4" x 3/4" x 5", 4 pieces
- 153334 diagonal cut, assort. 4-pc.\$17.89
159308 ebony, black & white, diag. cut \$23.99

- 3/4" x 3/4" x 5", 3 pieces
- 159305 mahogany, Honduras.....\$10.19

- 3/4" x 3/4" x 5", 2 pieces
- 162054 oak, antique French.....\$20.39
162060 bourbon stave.....\$9.19
162061 rum stave.....\$9.19
162062 tequila stave.....\$9.19
162063 red wine stave.....\$9.19
162064 red wine infused stave.....\$12.29

- 3/4" x 3/4" x 5", 1-piece
- 130654 amboyna.....\$10.19

- Buckeye Burl**, double dyed & stabilized
- 157771 gold/black.....\$10.19
157770 orange/black.....\$10.19
157766 pink/blue.....\$10.19
157769 red/black.....\$10.19
157768 red/yellow.....\$10.19

- Maple Burl**, double dyed & stabilized
- 157764 orange/black.....\$10.19
157760 pink/blue.....\$10.19
157762 red/yellow.....\$10.19

Hardwood Leg Stock Blanks

We have assembled a wide range of domestic and exotic hardwoods sized for furniture leg stock. Minimum 2" square with lengths ranging from 30" to 36". Kiln-dried and surfaced all four sides.

- 153324 ash 2" x 2" x 30".....\$11.99
153985 ash 2 1/2" x 2 1/2" x 36".....\$26.99
153315 ash 3" x 3" x 36".....\$34.50
50W59 cherry 2" x 2" x 30".....\$17.99
153316 cherry 3" x 3" x 36".....\$43.99
50W61 mahogany, African 2" x 2" x 30" \$23.79
153318 mahogany, African 3" x 3" x 36" \$52.50
153325 mahogany, Honduras.....\$29.99
153319 mahogany, Honduras.....\$63.79
50W62 maple, hard 2" x 2" x 30".....\$12.99
153317 maple, hard 3" x 3" x 36".....\$35.99
852108 maple, soft 2" x 2" x ".....\$11.99
840483 maple, soft 3" x 3" x 36".....\$33.50
131493 oak, red 2" x 2" x 30".....\$9.99
153987 oak, red 2 1/2" x 2 1/2" x 36".....\$23.99
153321 oak, red 3" x 3" x 36".....\$42.75
50W60 walnut 2" x 2" x 30".....\$35.99
153327 walnut 3" x 3" x 36".....\$91.99

PLEASE USE APPROPRIATE SAFETY MEASURES WHEN WORKING WITH THESE OR ANY OTHER WOODS -

Wood dust has been known to cause allergic reactions among some woodworkers. Always use proper respirators, dust extraction equipment and sufficient ventilation when cutting, sanding or finishing.

Pen Blanks. Stock listed at 3/4" x 3/4" x 5" is the ideal size for pen and pencil blanks.

Micro-Thin Lumber. This extra-thin stock (1/16" - 1/2") is cut to size from quality, kiln-dried stock, 100% clear and sanded on both sides.

Carving and Turning Blocks. Larger blocks are sawn to ± 1/4" of size listed, smaller blocks ± 1/8". Spindle stock (1 1/2" - 2") dimensions are ± 1/8". Grain runs with the longest dimension.

Note: Sapwood is not considered a defect by the National Hardwood Lumber Association and may be found in some boards. Sorry, we can't pick lumber for grain or color match.



SAVE \$10



**Ash
Baseball Bat
Billet**

Northern white ash sourced from Pennsylvania and upstate New York is recognized as the best material for making baseball bats. Ash makes a medium-weight bat. Vacuum-dried to a moisture content of 9-11%, graded for quality, and most importantly, straight grain, these billets offer superior strength and are suitable for college and all lower levels of play. Billets measure 27/8" in diameter and 37" in length.

152795 27/8" dia. x 37"
reg. \$25.49 **SALE: \$15.49**

Amazakoue

(*Guibourtia ehie*) Amazakoue is also called Shedua and Mozambique in west Africa. With a heartwood of yellow brown to dark brown with gray to almost black stripes, and straight grain, it polishes well and takes finish easily. Used in the back and sides of acoustic guitars. Native to Ghana.

- 161551** 2" x 2" x 6"**\$4.75**
- 154130** 2" x 6" x 6"**\$19.99**
- 154132** 3" x 3" x 12"**\$32.99**
- 154131** 3" x 6" x 6"**\$32.99**



Angelique

(*Dicorynia guianensis*) Imported from Surinam and Guyana, Angelique has reddish to brown heartwood that shows a wide purplish band. This very hard wood can be used as a Teak substitute.

- 160170** 3/4" x 3" x 5"**\$7.19**
- 160171** 3/4" x 4" x 48"**\$19.39**
- 160172** 3/4" x 6" x 36"**\$21.49**
- 160174** 1 1/2" x 1 1/2" x 24"**\$9.19**
- 160175** 2" x 2" x 24"**\$13.29**
- 160176** 3" x 3" x 12"**\$15.29**
- 160177** 4" x 4" x 8"**\$18.39**
- 160178** 4" x 6" x 6"**\$20.39**
- 160179** 3" x 8" x 8"**\$26.59**



Ash, White

(*Fraxinus americana*) Light brown heartwood with almost all white sapwood. Straight grain with coarse texture. Excellent bending properties and shock resistance. USA.

- 130707** 3/4" x 3" x 24"**\$8.19**
- 131599** 3/4" x 4" x 48"**\$13.29**
- 131544** 3/4" x 6" x 36"**\$12.79**
- 160863** 2 1/2" x 2 1/2" x 8"**\$3.09**
- 153322** 2 1/2" x 2 1/2" x 12"**\$6.50**
- 153323** 2 1/2" x 2 1/2" x 24"**\$14.99**
- 153985** 2 1/2" x 2 1/2" x 36"**\$26.99**
- 153324** 2" x 2" x 30"**\$11.99**
- 160118** 2" x 4" x 4"**\$5.09**
- 853832** 2" x 6" x 6"**\$10.19**
- 160119** 2" x 8" x 8"**\$20.39**
- 151286** 3" x 3" x 12"**\$16.50**
- 153315** 3" x 3" x 36"**\$34.50**



Basswood

(*Tilia americana*) Fine straight grain material with an even texture and little contrast between early and late wood. Creamy white in color and lighter in weight than the related European Lime. Fairly soft, preferred wood for carving. Canada and USA.

- 145131** 1/16" x 3" x 24"**\$2.99**
- 145128** 3/32" x 3" x 24"**\$3.29**
- 145132** 1/8" x 3" x 24"**\$3.59**
- 145129** 3/16" x 3" x 24"**\$3.79**
- 145133** 1/4" x 3" x 24"**\$4.29**
- 145134** 3/8" x 3" x 24"**\$4.89**
- 145130** 1/2" x 3" x 24"**\$7.29**
- 125369** 3/4" x 3" x 24"**\$9.19**
- 145118** 1/16" x 4" x 24"**\$3.99**
- 145117** 1/4" x 4" x 24"**\$6.69**
- 125370** 3/4" x 6" x 36"**\$12.79**
- 131606** 3/4" x 4" x 48"**\$17.39**
- 50W70** 2" x 2" x 12"**\$9.50**
- 125371** 2" x 4" x 12"**\$11.99**
- 125372** 2" x 6" x 18"**\$20.59**
- 50W71** 3" x 3" x 12"**\$11.50**
- 131143** 3" x 6" x 18"**\$27.99**
- 50W72** 4" x 4" x 12"**\$21.50**
- 50W73** 4" x 6" x 12"**\$31.99**
- 50W74** 4" x 6" x 18"**\$39.99**
- 50W77** 4" x 8" x 12"**\$35.99**
- 50W78** 4" x 8" x 18"**\$51.50**
- 149262** grab box**\$24.99**



Blackwood, African

(*Dalbergia melanoxylon*) Purplish black to dark brown with black streaks. Firm, heavy wood with exceptionally good working qualities. Cuts



Blackwood, Burmese

(*Dalbergia cultrata*)

This member of the rosewood family from South East Asia is dense and hard but carves, turns and polishes well. The heartwood is dark blackish brown with sections of dark red with black or purple streaks.

149792 2" @2" @12" @.....**\$12.49**



Bloodwood/Satine

(*Brosimum paraense*) Bloodwood, or "cardinal wood" as it is commonly referred to, is a medium to hard wood with red to crimson color and tight straight interlocking grain. Excellent for turning. South America.

- 131026** 1/8" x 3" x 24"**\$12.29**
- 131027** 1/4" x 3" x 24"**\$13.59**
- 131028** 3/8" x 3" x 24"**\$13.29**
- 131029** 1/2" x 3" x 24"**\$17.09**
- 06A58** 3/4" x 3" x 24"**\$21.69**
- 131607** 3/4" x 4" x 48"**\$37.49**
- 131547** 3/4" x 6" x 36"**\$34.49**
- 160113** 1 1/2" x 1 1/2" x 6"**\$4.09**
- 152603** 1 1/2" x 1 1/2" x 12"**\$7.99**
- 154271** 2" x 2" x 12"**\$14.25**
- 834940** 3" x 3" x 12"**\$24.79**
- 851553** 3" x 5" x 5"**\$17.39**
- 148516** 3" x 6" x 6"**\$27.50**



Bocote

(*Cordia* spp.) Spectacular background colors, dark brown to red with multi-colored strips that vary from yellow to orange and green to dark brown. Machines well, excellent turning stock. Somewhat hard to find wood from Mexico and Central America.

- 125362** 1/8" x 3" x 24"**\$13.29**
- 125363** 1/4" x 3" x 24"**\$13.79**

very smoothly and evenly, taking an excellent finish directly from the tool. Chiefly used for musical instruments, ornamental inlays and turned objects such as chess pieces and pool cues.

154319 1 1/2" x 1 1/2" x 3"**\$8.99**

African

Blackwood

Guitar Bridge Blanks

160249 5/8" x 17/8" x 7 1/2"**\$7.19**



- (Bocote)
- 125364** 3/8" x 3" x 24"**\$17.09**
- 130791** 1/2" x 3" x 24"**\$20.19**
- 124128** 3/4" x 3" x 24"**\$24.79**
- 148714** 1 1/2" x 1 1/2" x 3"**\$4.29**
- 840049** 1 1/2" x 1 1/2" x 6"**\$7.69**
- 124126** 1 1/2" x 1 1/2" x 12"**\$13.29**
- 834565** 1 1/2" x 1 1/2" x 18"**\$18.99**
- 841659** 1 1/2" x 1 1/2" x 24"**\$26.50**
- 834393** 2" x 2" x 12"**\$19.39**
- 125366** 2" x 2" x 18"**\$17.39**
- 125367** 2" x 2" x 24"**\$24.25**
- 848550** 2" x 2" x 36"**\$61.19**
- 125365** 2" x 6" x 6"**\$16.39**
- 830050** 3" x 3" x 12"**\$30.59**
- 840047** 3" x 6" x 6"**\$30.59**
- 841881** 3" x 3" x 8"**\$61.19**



Bubinga

(*Guibourtia* spp.) This African species, also known as African Rosewood, is a beautiful dense hardwood with a rose-colored background and darker purple striping. Turns well and takes a high polish. Machines well.

- 131202** 1/8" x 3" x 24"**\$12.50**
- 131203** 1/4" x 3" x 24"**\$12.99**
- 131204** 3/8" x 3" x 24"**\$11.99**
- 131205** 1/2" x 3" x 24"**\$18.99**
- 06A56** 3/4" x 3" x 24"**\$17.99**
- 131608** 3/4" x 4" x 48"**\$36.99**
- 131548** 3/4" x 6" x 36"**\$52.50**
- 848554** 1 1/2" x 1 1/2" x 3"**\$2.19**
- 131206** 2" x 2" x 24"**\$30.99**
- 125869** 2" x 6" x 6"**\$16.50**
- 125870** 2" x 8" x 8"**\$22.49**
- 841677** 3" x 3" x 12"**\$31.19**
- 158482** 4" x 4" x 8"**\$30.59**



Butternut

(*Juglans cinera*) Common names: Butternut, White Walnut, Oilnut. A straight-grained, coarse textured wood with medium brown to dark brown heartwood, Butternut sometimes has a reddish tint.

- 50W80** 2" x 2" x 12"**\$10.25**
- 159100** 2" x 4" x 12"**\$18.50**
- 50W81** 3" x 3" x 12"**\$20.59**

**MORE WOOD & KITS!
SEE YOUR LOCAL
WOODCRAFT STORE
OR VISIT**

www.woodcraft.com



African

Blackwood Tapped

Clarinet Bell Blanks

838037 appr. 3 1/4" sq. x 5" ..**\$10.19**



Canarywood

(*Centrolobium spp.*) Heartwood color can vary a fair amount, from a pale yellow-orange to a darker reddish-brown, usually with darker streaks throughout. Pale yellow sapwood is sharply demarcated from heartwood. Color tends to darken and homogenize with age.

06A79	1/8" x 3" x 24"	\$11.29
06A80	1/4" x 3" x 24"	\$13.29
06A81	3/8" x 3" x 24"	\$13.29
131234	1/2" x 3" x 24"	\$15.29
158376	3/4" x 3" x 24"	\$18.39
161713	3/4" x 3" x 24"	\$17.89
161714	3/4" x 3" x 36"	\$25.99
161715	3/4" x 4" x 24"	\$23.49
161716	3/4" x 4" x 36"	\$34.19
158377	3/4" x 4" x 48"	\$41.09
161717	3/4" x 5" x 24"	\$28.59
161718	3/4" x 5" x 36"	\$40.79
131549	3/4" x 6" x 36"	\$54.99
158372	1 1/2" x 1 1/2" x 6"	\$4.59
158373	1 1/2" x 1 1/2" x 12"	\$8.99
158374	2" x 2" x 6"	\$6.99
158375	2" x 2" x 12"	\$12.29
131210	2" x 2" x 24"	\$24.79
07A13	2" x 6" x 6"	\$19.39
826686	3" x 6" x 6"	\$27.59
826687	3" x 8" x 8"	\$48.99
827455	3" x 3" x 12"	\$27.59



Cedar, Aromatic Red

(*Juniperus virginiana*) Soft wood with aroma that is a natural repellent to moths and insects. Sapwood is white to cream intermixed and contrasts with the salmon to dark red of the heartwood. Expect tight closed knots throughout the material. USA.

124133	1/4" x 3" x 24"	\$9.19
130810	1/2" x 3" x 24"	\$10.49
131609	3/4" x 4" x 48"	\$24.99
131494	3/4" x 6" x 36"	\$16.09



Cedar, Spanish

(*Cedrela Odorata*) Light reddish brown to dark brown in color with grain texture similar to that of mahogany. Machines and carves well with hand and power tools. Strong yet lightweight. Traditionally used for cigar boxes and humidior linings.

124872	3/16" x 4" x 24"	\$7.69
127304	1/4" x 4" x 36"	\$11.29
127309	3/8" x 4" x 36"	\$11.79
131610	3/4" x 4" x 48"	\$24.29



Cherry

(*Prunus serotina*) USA.

50W11	1/16" x 3" x 24"	\$6.49
50W12	1/8" x 3" x 24"	\$7.19
50W13	1/4" x 3" x 24"	\$9.69
50W51	3/8" x 3" x 24"	\$14.09
130809	1/2" x 3" x 24"	\$13.79
131545	3/4" x 6" x 36"	\$23.79
131600	3/4" x 4" x 48"	\$24.29
153907	2" x 2" x 6"	\$3.09
50W59	2" x 2" x 30"	\$17.99
07A16	2" x 6" x 6"	\$12.29
07A28	2" x 8" x 8"	\$22.49
131555	3" x 3" x 12"	\$19.39
153316	3" x 3" x 36"	\$43.99
07A36	3" x 6" x 6"	\$27.29
123214	3" x 8" x 8"	\$30.89



Dalmata

(*Swartzia arborescens*) Also known as Dalmation. It is a warm reddish brown color with black or very dark brown streaks. This wood is very hard and can have twisted grain. Sharp tools are a requirement, but you will be rewarded with exceptional, stable work. Native to Peru.

851562	2" x 2" x 12"	\$14.25
--------	---------------	---------



Diamond Willow Walking Sticks

Diamond Willow is one of Mother Nature's true gems. It typically grows in northern climates, and ours comes from Minnesota. The diamond refers to willow which has been deformed while growing, at spots where branches begin to grow, the depression or diamond is formed. The wood is white with reddish-brown diamonds. Make a great walking stick by carving or just sanding and finishing. 4 1/2' to 5 1/2' long and 1" to 4" in diameter.

153534		\$13.99
--------	--	---------



Cebil

(*anadenanthera collubrina spp.*) or Patagonian Rosewood. is a very attractive wood. Similar to black cherry, but more figured and richer in color. Dark streaks or stripes throughout the wood. Much denser and harder than cherry. Widely used in South America for applications which require strength and durability. Native to Brazil.

148757	3" x 3" x 12"	\$26.50
839034	3" x 6" x 6"	\$25.50



Chakte Viga

(*Caesalpinia platyloba*) Also known as Mexican Pernambuco, is very easy to work. It has a nice orange color that darkens with time and often is strongly iridescent. A moderately hard wood, it is easy to work and has a slight odor when working. Central America.

841678	1 1/2" x 1 1/2" x 12"	\$12.29
841679	1 1/2" x 1 1/2" x 18"	\$13.50
841707	3" x 8" x 8"	\$45.39



Cherry, Brazilian

(*Hymenaea courbaril*) This reddish brown colored wood has a mahogany-like grain, superior hardness, yet machines and turns well. Color deepens with exposure to light. Central and South America.

130701	1/8" x 3" x 24"	\$7.39
130702	1/4" x 3" x 24"	\$7.69
130703	3/8" x 3" x 24"	\$8.69
124118	3/4" x 3" x 24"	\$9.19
131611	3/4" x 4" x 48"	\$22.99
131575	3/4" x 6" x 36"	\$29.59
124121	2" x 2" x 24"	\$17.59
124122	2" x 6" x 6"	\$14.29



Colonial Cypress®

In the 1600s and 1700s, American colonists harvest ed these timbers over 100 years ago when they were already 400 to 1,200 years old. Colors from these "sinker" logs range from cinnamon to honey to olive green. Buy Colonial Cypress to create your next

project, and reclaim a piece of history from these lost treasures!

160904	3/4" x 3" x 24"	\$19.39
160905	3/4" x 4" x 48"	\$50.99
160906	3/4" x 6" x 36"	\$61.19
160902	2" x 2" x 12"	\$13.79
160903	3" x 3" x 12"	\$30.59

Cocobolo (*Dalbergia sp.*)



Distinct Features:

- Kaleidoscope Of Colors
- Turns Deep Orange Red With Exposure
- Irregular Grain
- Hard, Heavy Wood
- Excellent Resistance To Decay

Cocobolo (*Dalbergia sp.*) can be seen in a kaleidoscope of different colors, ranging from yellow, orange, red, and shades of brown with streaks of black or purple. The color turns deep orange red with exposure. It is a hard and heavy wood with irregular grain with a medium fine texture. Like most rosewoods, it has natural oils that give it excellent resistance to decay. Cocobolo is used for fine furniture, musical instruments, knife scales, and small turnings such as pens and ornaments. Central America.

50X87	1/8" x 3" x 24"	\$40.39	838083	2" x 2" x 6"	\$19.39
50X89	3/8" x 3" x 24"	\$56.69	131585	2" x 2" x 12"	\$25.49
06A57	3/4" x 3" x 24"	\$60.50	130798	2" x 2" x 24"	\$53.09
838080	1" x 1" x 12"	\$10.19	838085	2" x 4" x 4"	\$18.69
845472	1 1/2" x 1 1/2" x 3"	\$6.19	838086	2" x 5" x 5"	\$28.09
160582	1 1/2" x 1 1/2" x 3", (4-pc.)	\$15.50	123745	2" x 6" x 6"	\$39.99
838081	1 1/2" x 1 1/2" x 6"	\$10.19	839051	2" x 8" x 8"	\$79.99
838082	1 1/2" x 1 1/2" x 12"	\$22.99	131213	3" x 6" x 6"	\$56.09



Ebiara
(Berlinia grandiflora) Also known as red zebrawood, Ebiara heartwood varies from pink-red to dark red-brown. Dark-purplish-brown irregular streaks or stripped veins are sometimes visible on quartered surfaces. Native to Africa.
159525 3/4" x 4" x 24".....\$20.25
159521 2" x 2" x 6".....\$7.19
159523 2" x 6" x 6".....\$21.69



Ebony, Black And White
(Diospyros embryopteris) Heartwood is creamy white with distinct black veins. The wood has a fine texture with mostly straight grain. A rare find. The wood takes a high finish and turns well. Southeast Asia and Laos.
146525 1" x 1" x 12".....\$12.29
149924 1 1/2" x 1 1/2" x 3".....\$12.50
158299 1 1/2" x 1 1/2" x 12".....\$25.49
146526 2" x 2" x 12".....\$47.99



Ebony, Macassar
(Diospyros celebica) Dark brown to black heartwood with bands of yellow to golden brown. Very hard, dense, and heavy, it can be very brittle at its heart. Southeast Asia.
158298 3/8" x 2 3/4" x 22".....\$20.99
131466 1" x 1" x 12".....\$12.89
131465 1 1/2" x 1 1/2" x 12".....\$20.39



PEN BLANKS & KNIFE SCALES
 PAGE 154



Granadillo
(Platymiscium ulei) Granadillo, also known as Coyote, Macacauba or Trebol is an extremely hard, satiny, reddish-brown wood with charming light cream colored highlights and swirling grain. Native to Honduras.
841752 1 1/2" x 1 1/2" x 12".....\$7.19
838723 3" x 3" x 12".....\$22.69

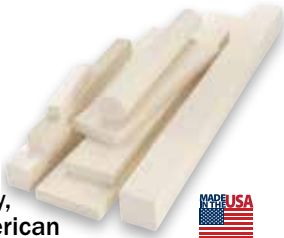

Holly, American
(Ilex opaca)
 A closed grained, moderately heavy, creamy white wood with almost indistinct growth rings. Quality holly "lumber" is rare. Supplies are limited. Eastern United States.
848849 2" x 2" x 6".....\$20.39
149071 2" x 2" x 12".....\$40.79



Hormigo Negro
(Platymiscium dimorphandrum)
 Hormigo Negro a dense, hard, reddish brown heartwood with dark stripes, machines well and polishes to a high gloss. Central America.
149643 1 1/2" x 1 1/2" x 12".....\$7.99
149648 3" x 6" x 6".....\$17.39



Ironwood, Suriname
(Swartzia spp.) Suriname Ironwood (Swartzia spp.) is native to Suriname and northern South America. The wood is a delicious chocolate brown with excellent figure and wild darker stripes. Although called Ironwood, it is not any harder than your typical exotic.
159725 3/4" x 3" x 24".....\$21.49
159719 1" x 1" x 12".....\$6.19
159720 1 1/2" x 1 1/2" x 3".....\$3.09
159721 1 1/2" x 1 1/2" x 12".....\$9.19
159722 2" x 2" x 12".....\$13.50
159723 3" x 3" x 12".....\$31.19



Jelutong
(Dyera costulata) is an important species in Malaysia. The wood is white or straw colored, and there is no differentiation between heartwood and sapwood. The texture is moderately fine and even, the grain is straight, and the luster is low. This wood is very easy to dry with little tendency to split or warp, but staining may cause trouble. It is easy to work, finishes well, and glues satisfactorily. Because of its low density and ease of working, it is great for carving.
159420 2" x 2" x 12".....\$9.25
159421 2" x 2" x 24".....\$16.79
159422 4" x 4" x 12".....\$31.50
159423 4" x 4" x 16".....\$38.50
159424 4" x 6" x 6".....\$25.99



Jobillo
(Astronium Graveolens)
 Jobillo (ho-BE-yo) from Central America has a light reddish brown heartwood streaked with sharply contrasting dark reddish to black bands that resemble burn marks. This wood is hard and heavy but turns well and will take a fine polish. This member of the cashew family produces stunning turned pieces because of the contrasting nature of its stripes.
843934 2" x 2" x 12".....\$18.69
840027 2" x 6" x 6".....\$25.99
843978 3" x 3" x 12".....\$29.09



Kingwood
(Dalbergia ceaserensis)
 A member of the rosewood family, the heartwood is a rich violet brown background shading to almost black. Streaks of black, violet black, and brown appear throughout the material. Sapwood is off-white. Brazil
838030 1" x 1" x 12".....\$15.29



Leopardwood
(Roupala montana)
 Leopardwood, is commonly light pink with a silvery sheen and exhibits a small flaky grain due to large rays. Fairly light weight, machines very well with both hand and power tools. Central and South America. Kiln dried.
161552 1/8" x 3" x 24".....\$15.25
161553 1/4" x 3" x 24".....\$16.50
161554 3/8" x 3" x 24".....\$16.50
161555 1/2" x 3" x 24".....\$17.50
161556 3/4" x 3" x 24".....\$19.99
161557 3/4" x 4" x 48".....\$50.59
161558 3/4" x 6" x 36".....\$62.50

Ebony, Gaboon (*Diospyros spp.*)



Distinct Features:

- Jet Black
- Finishes To A High Luster
- Straight Grain
- Very Durable
- High Density

The heartwood of Gaboon ebony (*Diospyros spp.*) is usually jet black, with little to no variation or visible grain. Occasionally dark brown or grayish-brown streaks may be present. Can be difficult to work due to its extremely high density. Has a dulling effect on cutters. Tear-out may occur on pieces that have interlocked or irregular grain. Takes finishes well, and finishes to a high luster. Ebony is commonly used for small ornamental purposes, such as piano keys, musical instrument parts, pool cues, carvings. Great for knobs, pulls, inlays and accents in cabinetry. An excellent turning wood, somewhat difficult to machine, but your efforts will be rewarded. Africa.

154686 1" x 1" x 6".....	\$10.25	847566 2" x 2" x 6".....	\$30.59
123741 1" x 1" x 12".....	\$14.29	123743 2" x 2" x 12".....	\$58.19
153512 1 1/2" x 1 1/2" x 3".....	\$10.19	154687 2" x 2" x 18".....	\$83.69
123742 1 1/2" x 1 1/2" x 12".....	\$40.79	844376 2" x 2" x 24".....	\$109.99
840216 1 1/2" x 1 1/2" x 18".....	\$50.99	838970 3" x 3" x 12".....	\$138.99
841747 1 1/2" x 1 1/2" x 24".....	\$83.69	154135 3/8" x 1 3/4" x 8".....	\$15.25
846343 2" x 2" x 3".....	\$17.89		

Wood



Lignum Vitae, Argentinean

(*Bulnesia sarmientoi*) A suitable substitute for the commonly known Lignum Vitae (genus Guaiacum). The heartwood from this small tree is fragrant and oily with a stable interlocked grain. It is extremely heavy, hard, dense and stable, yet turns well and polishes to a deep luster.

- 845473 1 1/2" x 1 1/2" x 3".... \$4.25
- 841652 1 1/2" x 1 1/2" x 18" \$20.39
- 838069 3" x 3" x 12".....\$56.50



Mahogany, Honduras

(*Swietenia macrophylla*) Perfect for carving, turning, and other wood-working. It cuts beautifully without chipping.

- 862821 3/4" x 3" x 24".....\$10.19
- 161106 3/4" x 8" x 48".....\$57.19
- 153325 2" x 2" x 30".....\$29.99
- 153319 3" x 3" x 36".....\$63.79
- 161107 4" x 4" x 8".....\$20.39



Maple

(*Acer saccharum*) USA

- 50W01 1/16" x 3" x 24".....\$7.69
- 50W02 1/8" x 3" x 24".....\$8.19
- 50W03 1/4" x 3" x 24".....\$8.99
- 50W50 3/8" x 3" x 24".....\$8.49
- 130808 1/2" x 3" x 24".....\$10.99
- 147605 3/4" x 6" x 36".....\$17.89
- 131602 3/4" x 4" x 48".....\$22.99
- 50W62 2" x 2" x 30".....\$12.99
- 131557 3" x 3" x 12".....\$14.79
- 153317 3" x 3" x 36".....\$35.99
- 158481 4" x 4" x 8".....\$21.49

Maple, Soft

(*Acer rubrum*) is about 25% softer than hard maples. It can be stained and polished to an excellent finish.

- 852108 2" x 2" x 30".....\$11.99
- 840479 3" x 3" x 12".....\$18.50
- 840483 3" x 3" x 36".....\$33.50



Maple, Burl, Big Leaf

(*Acer macrophyllum*) Unbelievable, swirly, unpredictable grain patterns with light to dark variations of cream brown to dark brown color. Natural edges, bark inclusions and internal voids may be present, but are not considered defects. Northwest USA.

- 153212 2 1/2" x 4" x 4".....\$10.69
- 153213 2 1/2" x 6" x 6".....\$21.69
- 153214 2 1/2" x 8" x 8".....\$37.99
- 153215 2 1/2" x 10" x 10".... \$64.79



Maple, Ambrosia

(*Acerrubrum*) Soft maple with defects from the Ambrosia Beetle. Includes pin holes, streaks of darker color on a white to cream background. Excellent turning stock. Air-dried, but green by lumber standards. Sealed to deter cracking.

- 131605 3/4" x 4" x 48".....\$14.29
- 131075 2" x 6" x 6".....\$8.59
- 131076 2" x 8" x 8".....\$10.69
- 131009 3" x 6" x 6".....\$13.99
- 131062 3" x 8" x 8".....\$21.69
- 131186 4" x 6" x 6".....\$14.99
- 131061 4" x 8" x 8".....\$24.99



Maple, Bird's Eye

(*Acer saccharum*) A natural occurrence found predominately in hard maple causes "eyes" to form that give a striking figure to the wood. Straight grain with intermittent eyes makes this a great accent wood. USA.

- 127342 1/8" x 5" x 24".....\$12.79
- 127343 1/4" x 5" x 24".....\$15.59
- 127344 3/8" x 5" x 24".....\$19.19
- 127345 3/4" x 5" x 24".....\$22.99
- 149760 1 1/2" x 1 1/2" x 5".....\$7.19
- 159457 1 1/2" x 1 1/2" x 18" ..\$20.39



Maple, Curly

(*Acer macrophyllum*) Unbelievable grain patterns that are curly or fiddle-backed. Color ranges from light cream to golden brown to reddish brown. USA and Canada.

- 847309 1/8" x 3" x 24".....\$14.29
- 131497 1/8" x 5" x 24".....\$14.09
- 847310 1/4" x 3" x 24".....\$14.99
- 131479 1/4" x 5" x 24".....\$14.79
- 847311 3/8" x 3" x 24".....\$17.39
- 131481 3/8" x 5" x 24".....\$17.39
- 847312 1/2" x 3" x 24".....\$20.39
- 847313 3/4" x 3" x 24".....\$24.25
- 131480 3/4" x 5" x 24".....\$23.79
- 131560 3/4" x 6" x 36".....\$32.89
- 151102 2.6" x 2.6" x 12".... \$20.69

Figured Maple Billets

The prized beauty of Figured Maple can be quilted, flame, tiger, curly or fiddleback. Our billets come from one of the leading suppliers of music-grade wood to luthiers around the globe. These billets, while excellent examples of figured maple, have a minor defect - either a discoloration or minor pin knot - that does not allow them to be graded as instrument quality.



Marblewood

(*Marmaroxylon racemosum*) Marblewood is smooth and straight-grained with a fine, even texture. The heartwood is yellow-beige with maroon to black wavy streaks. Used for cabinet work, inlay, carving and turnings. Brazil.

- 149231 3/4" x 3" x 24"..... \$25.79
- 148732 3/4" x 4" x 48".....\$30.59
- 159408 1 1/2" x 1 1/2" x 3"..... \$4.59
- 154602 1 1/2" x 1 1/2" x 12" ..\$11.99
- 149230 1 1/2" x 1 1/2" x 24" ..\$23.99
- 154603 2" x 2" x 6".....\$7.39
- 131565 2" x 2" x 12".....\$12.99
- 131566 2" x 6" x 6".....\$22.75
- 834930 3" x 3" x 12".....\$29.99
- 837403 3" x 6" x 6".....\$27.09
- 158509 4" x 4" x 8".....\$36.50
- 158510 4" x 6" x 6".....\$34.99



Mesquite, Black

(*Prosopis nigra*) Black Mesquite is a heavy hardwood that ranges from rich brown to chocolate with purple overtones in color with a grain structure resembling mahogany. Argentina, South America.

- 158986 1/8" x 3" x 24".....\$15.59
- 158987 1/4" x 3" x 24".....\$18.39
- 158989 1/2" x 3" x 24".....\$21.69
- 158990 3/4" x 3" x 24".....\$24.79
- 158991 3/4" x 4" x 48".....\$41.89
- 158992 3/4" x 6" x 36".....\$46.49
- 151143 2" x 2" x 6".....\$6.25



Oak, Red

(*Quercus rubra*) USA.

- 50Y32 1/8" x 3" x 24".....\$7.69
- 50Y33 1/4" x 3" x 24".....\$8.19
- 50Y34 3/8" x 3" x 24".....\$8.49
- 130807 1/2" x 3" x 24".....\$10.19
- 131603 3/4" x 4" x 48".....\$16.39
- 131579 3/4" x 6" x 36".....\$16.59
- 131493 2" x 2" x 30".....\$9.99
- 160862 2 1/2" x 2 1/2" x 8".....\$3.75
- 153987 2 1/2" x 2 1/2" x 36" ..\$23.99

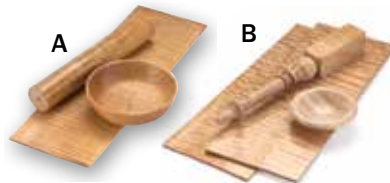

- 7"-11" wide, 22"-28" long, 2 1/4" thick
- 152788 (A) flame maple.....\$51.59
- 152789 (B) quilted maple..\$72.49

- 6"-10" wide, 22" long, 1 1/4" thick
- 158369 (A) flame maple.....\$30.59
- 158368 (B) quilted maple..\$40.79



Olivewood

NEW!

(*Olea capensis*) Light to medium brown with streaks of black and darker brown. Has a fine texture with a shallow interlocked grain. Glues and polishes well. Excellent for decorative turnings, inlay, and high end custom furniture. Central African Republic.

- 162646 7/8" x 3" x 30".....\$24.99
- 162645 7/8" x 3" x 42".....\$29.99
- 162644 7/8" x 4 1/4" x 55".....\$59.99
- 826213 1 1/2" x 1 1/2" x 3".....\$6.99
- 838041 1 1/2" x 1 1/2" x 6".....\$14.79
- 838042 1 1/2" x 1 1/2" x 12" ..\$23.99
- 827323 2" x 2" x 12".....\$45.89
- 826645 2" x 2" x 6".....\$17.39
- 830049 3" x 3" x 12".....\$79.59
- 842373 3" x 5" x 5".....\$57.99



Bethlehem Olivewood

(*Olea Europaea*) This dramatic and beautiful wood is milled from prunings and trees that no longer produce fruit. The wood comes from the Galilee region of Israel which was the home of Jesus for at least 30 years of his life. Each piece has a unique figure and history. The older the tree is the broader and more gnarled the trunk appears. This very hard and close grained wood is yellow or light greenish-brown and is often finely veined with a darker tint.

- 153845 1 1/2" x 1 1/2" x 6".....\$17.89
- 153846 1 1/2" x 1 1/2" x 12" ..\$30.59
- 153847 2" x 2" x 6".....\$21.99
- 153848 2" x 2" x 12".....\$40.79



Orange Agate

Orange Agate (*Platymiscium spp.*) is an orange/brown to dark brown colored wood. It can be mistaken for a variation of Cocobolo, but they are not related. This wood is hard, beautifully grained and works and finishes like a dream. Native to Peru.

- 854206 2" x 2" x 12".....\$13.50
- 851606 3" x 3" x 12".....\$28.99
- 851607 3" x 5" x 5".... D/S \$18.39

D/S = Item drop ships direct from manufacturer.

Tagua Nuts

A practical alternative to animal ivory used for jewelry, inlay work, buttons, miniatures, scrimshaw, etc. Tagua is very hard and can be lathe turned or easily carved, then stained, buffed or polished. 1 3/8" to 1 3/4" diameter. South America.

- 128175 5-piece.....\$10.99



Osage Orange, Argentine Orange

(*Maclura tinctoria*) Unlike the common domestic Osage (*Maclura pomifera*) which darkens considerably with age, this Argentinean species tends to keep its deep golden orange color. The heartwood is accentuated by bands of darker and lighter grain. This wood is heavy, hard, dense and stable, yet turns well and polishes to a deep luster.

- 159031 1/8" x 3" x 24".....\$15.59
- 159032 1/4" x 3" x 24".....\$18.39
- 159033 3/8" x 3" x 24".....\$18.39
- 131109 1/2" x 3" x 24".....\$21.49
- 124686 3/4" x 3" x 24".....\$24.49
- 159034 3/4" x 4" x 48".....\$41.89
- 159035 3/4" x 6" x 36".....\$46.49
- 838057 1 1/2" x 1 1/2" x 12".....\$7.99
- 841807 1 1/2" x 1 1/2" x 18".....\$14.99
- 838059 2" x 2" x 12".....\$12.49
- 841878 2" x 2" x 18".....\$19.69
- 842801 2" x 2" x 24".....\$24.79
- 838063 2" x 6" x 6".....\$16.09

Padauk

(*Pterocarpus soyauxii*) Medium to hard wood, heartwood is deep orange red that will age to a deeper orange brown. Moderately coarse grain texture with straight to interlocking grain patterns, turns well. W. Africa.

- 50X71 1/8" x 3" x 24".....\$14.75
- 50X72 1/4" x 3" x 24".....\$17.25
- 50X73 3/8" x 3" x 24".....\$21.50
- 06A55 3/4" x 3" x 24".....\$23.50
- 131550 3/4" x 6" x 36".....\$44.99
- 845476 1 1/2" x 1 1/2" x 3".....\$3.75
- 827343 2" x 2" x 12".....\$10.99
- 06A94 2" x 2" x 24".....\$16.99
- 07A21 2" x 6" x 6".....\$14.79
- 07A33 2" x 8" x 8".....\$25.75
- 841808 3" x 5" x 5".....\$19.99
- 130978 3" x 6" x 6".....\$20.39
- 828465 3" x 3" x 12".....\$32.19
- 130649 10" x 10" x 3".....\$61.19

Palm, Black

(*Borassus flabellifer*) From Asia, has a brown background streaked with elongated dark brown and black vascular bundles. This wood is hard and heavy and the bundles can be quite stringy, so extremely sharp tools are required.

- 847052 1/8" x 3" x 24".....\$18.99
- 847053 1/4" x 3" x 24".....\$20.50
- 847054 3/8" x 3" x 24".....\$23.99
- 847055 1/2" x 3" x 24".....\$23.75
- 847056 3/4" x 3" x 24".....\$24.50
- 152758 3/4" x 3" x 36".....\$35.69
- 845470 1 1/2" x 1 1/2" x 3".....\$3.99
- 842343 1 1/2" x 1 1/2" x 12".....\$9.25
- 843623 1 1/2" x 1 1/2" x 18".....\$14.75
- 150703 1 1/2" x 1 1/2" x 24".....\$17.99
- 834621 2" x 2" x 12".....\$12.99
- 834391 2" x 2" x 24".....\$25.49
- 150710 2" x 4" x 4".....\$9.99

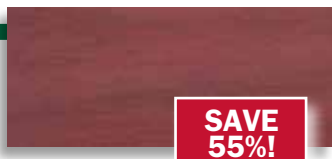

Purpleheart

(*Peltogyne*) Medium to hard wood with tight, fairly straight grain with moderate to coarse texture. Bright purple when cut, darkens to brownish purple with exposure. Machines well with sharp tools. Turns and finishes well. Central and South America.

- 50X75 1/8" x 3" x 24".....\$10.50
- 50X76 1/4" x 3" x 24".....\$13.50
- 50X77 3/8" x 3" x 24".....\$13.50
- 130806 1/2" x 3" x 24".....\$14.50
- 153701 3/4" x 3" x 24".....reg. \$12.99 SALE: \$5.84
- 06A18 3/4" x 3" x 24".....\$20.50
- 153702 3/4" x 3" x 36".....reg. \$14.99 SALE: \$6.74
- 839670 3/4" x 4" x 24".....reg. \$15.99 SALE: \$7.19
- 839671 3/4" x 4" x 36".....reg. \$18.99 SALE: \$8.54
- 131613 3/4" x 4" x 48".....\$35.25
- 153699 3/4" x 5" x 24".....reg. \$18.99 SALE: \$8.54
- 153700 3/4" x 5" x 36".....reg. \$25.99 SALE: \$11.69
- 131551 3/4" x 6" x 36".....\$44.99
- 848997 1 1/2" x 1 1/2" x 3".....\$2.50
- 843620 1 1/2" x 1 1/2" x 12".....\$6.99
- 854208 1 1/2" x 1 1/2" x 24".....\$11.99
- 834564 2" x 2" x 12".....\$9.99
- 06A92 2" x 2" x 24".....\$18.69
- 07A11 2" x 6" x 6".....\$14.75
- 07A23 2" x 8" x 8".....\$17.75
- 828466 3" x 3" x 12".....\$24.49
- 841814 3" x 5" x 5".....\$11.79
- 130977 3" x 6" x 6".....\$20.39



Pink Ivory

(*Berberia zeyheri*) Heartwood varies from light to dark pink, and red with lighter shades of cream. Sapwood is light cream to off-white. Turns well. Pink Ivory is one of the most unusual woods you'll find and we've obtained a high quality supply. Stock is air dried, green by lumber standards, with the ends waxed to deter checking. Africa.

- 826392 1 1/2" x 1 1/2" x 6".....\$15.89

freud

Our Selection Of FREUD Router Bits Will Help You Custom Craft Your Latest Project - see page 40

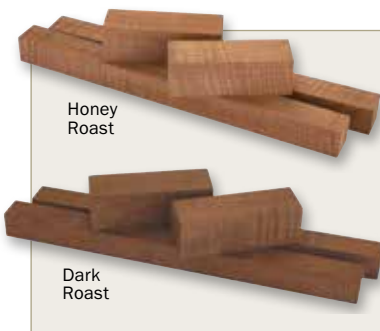

Quina

(*Myroxylon poruiferum*) The heartwood color is deep red, sometimes with purple highlights and high natural luster. Quina has a spicy scent, and is a source of balsam used in perfumes.

- 148657 2" x 2" x 12".....\$7.99



Redheart

(*Erythroxylon* spp.) Pale to dark red that will deepen in color with age. Grain is straight and tight. Machines well but has a tendency to burn. Turns well. Fresh cut material has a bright red look that will darken with exposure. Central America.

- 154011 1/8" x 3" x 24".....\$21.50
- 154012 1/4" x 3" x 24".....\$27.50
- 154013 3/8" x 3" x 24".....\$26.50
- 154014 1/2" x 3" x 24".....\$31.50
- 154015 3/4" x 3" x 24".....\$34.50
- 148573 1" x 1" x 12".....\$4.99
- 152792 1 1/2" x 1 1/2" x 3".....\$3.99
- 838090 1 1/2" x 1 1/2" x 12".....\$9.25
- 06A36 2" x 2" x 12".....\$15.25
- 842804 2" x 2" x 18".....\$20.39
- 07A12 2" x 6" x 6".....\$26.09
- 838499 3" x 3" x 12".....\$45.99



Rosewood, Bolivian

(*Machaerium schelerxylon*) Commonly known as "Morado", this wood is deep, dark chocolate brown to purple black in color with occasional strips of even darker grain patterns. This species is hard and heavy with a fine texture with variable tones and when worked, exhibits a smell reminiscent of walnut. Machines well with sharp tools. Excellent for turning. South America.

- 06A83 1/8" x 3" x 24".....\$14.09
- 06A84 1/4" x 3" x 24".....\$16.89
- 06A85 3/8" x 3" x 24".....\$19.39
- 06A53 3/4" x 3" x 24".....\$21.19
- 153483 1 1/2" x 1 1/2" x 3".....\$7.19



Rosewood, Burmese

(*Dalbergia olivera*) Like most rosewoods, the heartwood has variegated colors from burgundy to light brown. This south East Asian wood is hard and dense with medium fine texture and maintains its color well.

- 158901 3/4" x 3" x 24".....\$25.49
- 153991 1 1/2" x 1 1/2" x 12".....\$11.75
- 153992 2" x 2" x 12".....\$15.29



Rosewood, Honduran

(*Dalbergia stevensonii*) Heartwood color can range from a deep brownish-purple to a light-brown. Most common is a brownish-mauve color. Sapwood is a striking contrast of creamy white. Central America.

- 838073 1 1/2" x 1 1/2" x 12".....\$12.99
- 838075 2" x 2" x 12".....\$28.99
- 841783 2" x 2" x 24".....\$45.99

MORE WOOD & KITS!
VISIT YOUR STORE OR
www.woodcraft.com



Rosewood, Yucatan

(*Dalbergia yucatanensis*) Yucatan Rosewood is a hard, light-reddish cinnamon brown wood with darker-reddish brown stripes from the regions of Central and South America. It turns well and has fewer allergenic properties than other *Dalbergia*, such as Cocobolo and Honduras Rosewood. Commonly used in the region for furniture, musical instruments, and sports equipment.

- 152890 1 1/2" x 1 1/2" x 3".....\$4.25
- 844924 1 1/2" x 1 1/2" x 6".....\$5.99
- 149788 1 1/2" x 1 1/2" x 12".....\$11.50
- 847341 1 1/2" x 1 1/2" x 24".....\$13.50

Thermally Modified (Roasted) Figured Maple

Roasted or Thermally Modified Wood-a process that uses high heat in a controlled atmosphere so the wood resists warp, movement, retains stiffness, strength and integrity without using chemicals. This TM Figured Maple, offers stability and resistance to humidity and temperature changes. We offer both Honey Roasted (HR) and Dark Roasted (DR) Wood.

- 159429 3/4" x 3/4" x 5" pen blank....HR, 2-pc.\$4.09
- 159430 3/4" x 3/4" x 5" pen blank....DR, 2-pc.\$4.09
- 159838 3/4" x 3" x 24" HR.....\$21.49
- 159839 3/4" x 3" x 24" DR.....\$27.09
- 159425 (A) 1 1/2" x 1 1/2" x 18" HR.....\$15.29
- 159426 (B) 1 1/2" x 1 1/2" x 18" DR.....\$16.39
- 159427 2" x 2" x 6" HR.....\$9.69
- 159428 2" x 2" x 6" DR.....\$9.69



Spalted Tamarind

(Tamarindus indica) Spalted Tamarind has a spectacular heartwood with back ground colors of ivory, yellow and black lines, giving it a landscape effect. Turns and finishes well. Bug and worm holes may be present on some blanks, no two are alike. Laos.

- 157773 3/4" x 3" x 24"\$23.99
- 845477 1 1/2" x 1 1/2" x 3" \$4.09
- 842800 1 1/2" x 1 1/2" x 12" \$8.99
- 842328 3" x 3" x 12".....\$40.29
- 840038 3" x 6" x 6".....\$31.99



Sycamore

(Platanus occidentalis) Sycamore has a whitish to light yellow sapwood with a darker reddish brown heartwood. The quartersawn face exhibits rays with a distinct dark "fleck" or "flake" figure due to its interlocked grain.

- 150997 1 1/2" x 1 1/2" x 12" \$5.69
- 150998 2" x 2" x 12".....\$8.19
- 150999 2" x 4" x 4".....\$5.59
- 151000 2" x 6" x 6".....\$12.79
- 149863 3" x 3" x 12".....\$14.29
- 152689 3" x 6" x 6"..... \$17.39



Turner's Grab Bag #2

Premium exotic and domestic stock 2" square, in 3" to 12" lengths. Each pack will contain 8 to 12 pieces (4 1/2 to 5 1/2 lbs).

- 150257 \$27.99



Tupelo

(Nyssa aquatica) A premier power carving stock, ours is cut "below the water line" by an experienced carver and logger. Great for detailing and texturing. Cream to light tan in color. Southeast United States.

- 159526 3" x 6" x 12"\$20.99
- 17B53 4" x 4" x 12"\$17.50
- 17B54 4" x 6" x 12"\$25.25
- 17B55 4" x 6" x 18"\$37.50
- 17B58 4" x 8" x 18" \$48.99



Walnut, Black

(Juglans nigra) USA.

- 50W04 1/16" x 3" x 24"\$7.09
- 50W05 1/8" x 3" x 24".....\$8.69
- 50W06 1/4" x 3" x 24".....\$11.39
- 50W52 3/8" x 3" x 24".....\$13.79
- 130830 1/2" x 3" x 24".....\$12.79
- 131562 3/4" x 6" x 36".....\$34.99
- 131601 3/4" x 4" x 48"\$30.39
- 159414 1 1/2" x 1 1/2" x 3".....\$2.59
- 50W60 2" x 2" x 30".....\$35.99
- 07A14 2" x 6" x 6".....\$18.75
- 07A26 2" x 8" x 8".....\$26.75
- 131554 3" x 3" x 12".....\$24.69
- 153327 3" x 3" x 36".....\$91.99



Wenge

(Millettia laurentii) Dark brown in color with very close grain and fine black veins. Fairly straight grained with coarse texture. Works fair with hand and machine tools and is an excellent turning stock. Used for interior or exterior joinery. Africa.

- 127615 3/4" x 3" x 24".....\$25.29
- 159409 1 1/2" x 1 1/2" x 3" \$4.09
- 131132 2" x 2" x 24".....\$27.79



DymaLux® Turning Blanks 1 1/2" dia. x 6"

DymaLux produces these blanks from Grade A Birch Veneers that are first dyed in stunning colors, dried and then injected with a plastic-like resin adhesive. When these veneers are laminated together under enormous amounts of heat and pressure, the material becomes an extremely dense, rock hard, waterproof, heat resistant Birch laminate that finishes beautifully with no added product. Just sand it to a beautiful shine and glassy feel. Common uses for DymaLux include pistol and bow grips, knife handles, game calls, billiard tables and cues. Blanks are doweled for easy turning. Made in the USA.

- 161807 Camo Supreme \$14.99
- 161808 Americana \$14.99
- 161809 Green Hornet \$14.99
- 161810 Rosewood..... \$14.99
- 161811 Dreamsicle\$14.99
- 161812 Walnut.....\$14.99
- 161813 Citrus.....\$14.99
- 161814 Chocolate Mint.....\$14.99



Yellowheart

(Euxylophora paraensis) Fine straight grained hardwood with bright yellow color throughout the wood. Machines well and is an excellent turning stock. Great for adding accents to projects. Central America.

- 124026 1/8" x 3" x 24".....\$10.49
- 124027 1/4" x 3" x 24".....\$11.79
- 124029 3/4" x 3" x 24".....\$14.59
- 131615 3/4" x 4" x 48"\$28.59
- 124031 2" x 2" x 24".....\$16.59
- 124032 2" x 6" x 6".....\$16.39

Zapote

(Pouteria sapota), also known as Chico Zapote, is

a very hard, strong, dense wood. Its color varies from a deep, solid reddish-brown to a light reddish-orange, and it often displays a combination of both colors. Sapwood is cream in color and makes for a nice contrast against the red hues. It is normal for Zapote to have some minor checking and/or gum pockets.

- 841829 2" x 2" x 12".....\$9.99
- 841849 3" x 6" x 6".....\$28.99



Finished samples used to demonstrate Veneer glue-up

Skateboard Veneers

Rock Hard Maple, 7-ply

Rock Hard Maple (*Acer saccharum*) is the hard, strong, and tough veneer



Basswood Grab Bag #1

Contains approximately 10 lbs. (5 1/2+ bd. ft.) of various sized pieces. A preferred wood for carving. Canada and USA.

- 149262 \$24.99

Turning Kits sold separately

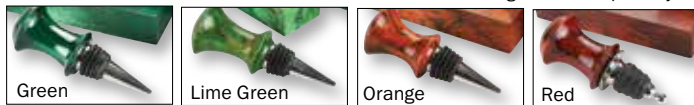

Stabilized

Spalted Tamarind

(Tamarindus indica) Spalted Tamarind has a spectacular heartwood with background colors of ivory, yellow and black lines. Turns and finishes well. Due to the nature of the species, bug and worm holes may be present on some blanks and no two are alike. Turning blanks have been stabilized by injecting an acrylic resin to help eliminate checking and

cracking due to expansion or contraction, then they are dyed a range of vibrant colors. Use adequate dust collection equipment and wear a personal respirator or mask when working spalted woods. Native to Laos.

- | Green | Lime Green | Orange | Red | Yellow |
|--|--------------|--------|--------|--------|
| 3/4" x 3/4" x 5" pen blank, 1 piece |\$6.99 | | | |
| 161527 | 161531 | 161535 | 161539 | 161543 |
| 1" x 1 1/2" x 5" knife scales, 1 piece |\$20.99 | | | |
| 161528 | 161532 | 161536 | 161540 | 161544 |
| 1 1/2" x 1 1/2" x 3", 1 piece |\$10.50 | | | |
| 161529 | 161533 | 161537 | 161541 | 161545 |
| 1 1/2" x 1 1/2" x 6", 1 piece |\$25.50 | | | |
| 161530 | 161534 | 161538 | 161542 | 161546 |

Alabama
Birmingham/Pelham:
205-988-3600
2215B Pelham Parkway N.
Pelham, AL 35124

Arizona
Phoenix/Chandler:
480-539-9663
3002 N Arizona Ave. Ste. 12
Chandler, AZ 85225
Tucson:
520-742-9663
Oracle Plaza Shopping Ctr
6230 N. Oracle Road #100
Tucson, AZ 85704

California
Orange County:
714-963-9663
10770 Talbert Avenue
Fountain Valley, CA 92708
Sacramento:
916-362-9664
9523 Folsom Blvd.
Sacramento, CA 95827
San Francisco Bay Area:
San Carlos:
650-631-9663
40 El Camino Real
San Carlos, CA 94070
Ventura:
805-658-9663
3860 East Main Street
Ventura, CA 93003

Colorado
Colorado Springs:
719-266-9889
750 West Garden of the
Gods Road #130
Colorado Springs, CO
80907
Denver:
303-290-0007
6770 S. Peoria St.
Centennial, CO 80112
Loveland:
970-292-5940
3718 Draft Horse Road
Loveland, CO 80538

Connecticut
Hartford/Manchester:
860-647-0303
249 Spencer Street
Manchester, CT 06040
Norwalk:
Woodworker's Club
203-847-9663
215 Westport Avenue
Norwalk, CT 06851

Delaware
Wilmington/New Castle:
302-323-0400
Shoppes of New Castle
166 S Dupont Hwy, Ste. H
New Castle, DE 19720

Florida
Jacksonville:
904-721-9796
11160 Beach Blvd.,
Suite 121
Jacksonville, FL 32246
Orlando:
407-260-5002
8155 So. US Hwy. 17-92
Fern Park, FL 32730
Tampa/Clearwater:
727-532-6888
2864 Roosevelt Blvd.
Clearwater, FL 33760

Georgia
Atlanta:
770-587-3372
8560 Holcomb Bridge Rd.
Suite 115
Alpharetta, GA 30022
West Atlanta:
770-485-5636
351 Thornton Rd.,
Suite 102
Lithia Springs, GA 30122
Hawaii
Honolulu:
808-841-9876
1311 Kalani Street
Honolulu, HI 96817
Idaho
Boise:
208-338-1190
Overland Park Shop Ctr.
7005 West Overland Rd.
Boise, ID 83709
Illinois
Chicago Area:
Woodridge:
630-435-9663
7440 Woodward Ave.
Suite A 107
Woodridge, IL 60517
Indiana
Indianapolis:
317-578-3400
7330 East 86th Street
Indianapolis, IN 46256
Kansas
Kansas City/Lenexa:
913-599-2800
8645 Bluejacket Road
Lenexa, KS 66214
Kentucky
Lexington:
859-231-9663
3028 Blake James Drive
Lexington, KY 40509
Louisville:
502-671-0900
1850 So. Hurstbourne
Parkway, Suite 148
Louisville, KY 40220

Maryland
Rockville:
Woodworker's Club
301-984-9033
11910-L Parklawn Drive
Rockville, MD 20852

Massachusetts
Woburn:
781-935-6414
185 New Boston Street
Woburn, MA 01801
Walpole:
508-668-2413
3 Walpole Park South
Walpole, MA 02081
West Springfield:
413-827-0244
239A Memorial Avenue
W. Springfield, MA 01089

Michigan
Detroit Area:
Canton:
734-981-6808
42102 Ford Road
Canton, MI 48187
Sterling Heights:
586-268-1919
39245 Van Dyke Hwy.
Sterling Hts, MI 48313
Grand Rapids:
616-957-9663
4265 28th St. SE., Suite C
Grand Rapids, MI 49512
Saginaw:
989-249-6662
3005 Bay Plaza Drive
Saginaw, MI 48604

Minnesota
Minneapolis/
Bloomington:
952-884-3634
9125 Lyndale Ave. South
Bloomington, MN 55420

Missouri
St. Louis/
Maryland Heights:
314-993-0413
2077 Congressional Drive
West Port Area
St. Louis, MO 63146

New Hampshire
Portsmouth/Newington:
603-433-6116
25 Fox Run Road
Newington, NH 03801

New York
Rochester:
585-292-9690
Henrietta Plaza
1100 Jefferson Road
Rochester, NY 14623

North Carolina
Charlotte/Matthews:
704-847-8300
1725 Windsor Square Dr.
Matthews, NC 28105
Raleigh:
919-781-1911
4317 Pleasant Valley Rd.
Raleigh, NC 27612

Ohio
Cincinnati:
New Location!
513-407-8371
Tri-County Towne Center
11711 Princeton Pike,
Suite 271
Cincinnati, OH 45246
Cleveland/
Oakwood Village:
440-232-7979
Hawthorne Valley
Shopping Center
23226 Broadway Ave.
Oakwood Village, OH 44146
Columbus:
614-273-0488
1077 Bethel Road
Columbus, OH 43220
Dayton:
937-438-1282
Cross Pointe Centre
175 East Alex-Bell Rd #264
Dayton, OH 45459
Toledo:
419-389-0560
5311 Airport Highway
Toledo, OH 43615

Oklahoma
Oklahoma City:
405-748-8844
9301 N. May Avenue
Oklahoma City, OK 73120
Tulsa:
918-384-0100
5511 E. 41st Street
Tulsa, OK 74135

Oregon
Eugene:
541-685-0677
1052 Green Acres Rd.
Delta Oaks Shopping Ctr.
Eugene, OR 97408
Portland/Tigard:
503-684-1428
12020 So. W. Main Street
Tigard, OR 97223

Pennsylvania
Allentown:
610-351-2966
Parkway Shopping Center
1543 Lehigh Street
Allentown, PA 18103

Canonsburg:
New Location!
724-916-4403
102 Four Coins Dr. Ext.
Suite 3
Canonsburg, PA 15317
Harrisburg:
717-409-8173
3831 Union Deposit Rd.
Harrisburg, PA 17109
Philadelphia/
Downingtown:
610-873-5660
417 Boot Road
Downingtown, PA 19335

South Carolina
Greenville:
864-627-8760
1327 Miller Road
Greenville, SC 29607

Tennessee
Chattanooga:
423-710-8001
5824 Brainerd Rd.
Chattanooga, TN 37411
Knoxville:
865-539-9330
8023 Kingston Pike
Knoxville, TN 37919
Nashville:
615-599-9638
209 South Royal Oaks Blvd.
Suite #164
Franklin, TN 37064

Texas
Austin:
512-407-8787
10901 IH35 North
Austin, TX 78753
Dallas/Plano:
972-422-2732
601 West Plano Parkway
Suite 145
Plano, TX 75075
Fort Worth:
682-334-1025
754 Grapevine Highway
Hurst, TX 76054
Houston North:
281-880-0045
Cypress Station Square
60 FM 1960 West
Houston, TX 77090
Houston Southwest:
281-988-9449
11707 South Sam Houston
Parkway West
Houston, TX 77031
San Antonio:
210-545-5885
13719 San Pedro
San Antonio, TX 78232

Utah
Salt Lake City/Sandy:
801-566-5652
8932 South State Street
Sandy, UT 84070

Virginia
Leesburg:
703-737-7880
Battlefield Plaza Shop. Cntr.
1067 Edwards Ferry Rd., NE
Leesburg, VA 20176
Norfolk:
757-466-1166
Shops at Janaf, Suite 152
5802 East Va. Beach Blvd.
Norfolk, VA 23502
Richmond:
804-355-3945
9862 West Broad Street
Glen Allen, VA 23060
Roanoke:
540-366-7144
1445 Towne Square Blvd.
Roanoke, VA 24012
Springfield:
703-912-6727
Ravensworth Shopping Cntr.
5248 Port Royal Road
Springfield, VA 22151

Washington
Seattle:
206-767-6394
5963 Corson Ave, Ste. 120
Seattle, WA 98108
Spokane:
509-892-9663
212 N. Sullivan Rd. Ste. C
Spokane Valley, WA 99037

West Virginia
Parkersburg:
304-485-4050
4420 Emerson Avenue
Parkersburg, WV 26104

Wisconsin
Appleton/Fox Cities:
920-730-9663
4731 Michael's Drive
Appleton, WI 54913
Madison:
608-273-8868
6594 Monona Drive
Monona, WI 53716
Milwaukee/New Berlin:
262-785-6770
14115 West Greenfield Ave.
New Berlin, WI 53151



Xstrap Heavy-Duty Ratchet Tie Down
Haul your finds home with this Heavy-Duty Ratchet Tie Down. 1,000-lb. capacity with 3,000-lb. break strength and heavy-duty straps will keep your load where you put it. Ratchet mechanism engages easily and cinches smoothly. Bright orange color makes straps easy to see. Ideal for toolbox, garage or truck.
162615 2-pack.....\$14.99



LOOPER Multi-Purpose Carrying Straps
Organize, hang, carry and more – each Looper has a molded red handle for hanging and carrying and a reinforced elastic band. Loop the elastic through itself and around your item (like an extension cord) and then hang it out of the way. Add a handle to a bunch of bags to help you carry them in. Add a Looper to a bucket handle to hang it out of the way or from a ladder while working. The possibilities are endless. Includes two small and two larger Loopers.
162616 4-pack.....\$8.99



PERFORMANCE TOOL 700W Variable Speed Portable Shop Blower
The Performance Tool Portable Shop variable-speed shop blower will help you keep your bench, floor and even sidewalks clear of debris. The unit features six speeds, a 9" nozzle and optional 9" extension. Extension cord required (not included). Ideal for home, shop, garage, yard and more!
162504\$49.99

Ordering Information

**Orders Received By 12pm EST
Are Shipped The Same Day!**

Woodcraft's Guarantee

We're absolutely confident that you'll be satisfied with your purchase from Woodcraft! If you're not, return it anytime within 90 days, and we will gladly replace the product, give you credit, or refund your money, whichever you prefer. Woodcraft's Guarantee does not apply to power tools, which are subject only to manufacturers' warranties. Special-order items or manufacturer drop ships are subject to a 25% restocking fee.

Ordering By Mail

Simply place your order using the included order form and mail to the address indicated. If an order form is not included in this catalog simply order by telephone - call 800 225-1153

Ordering By Telephone

Order toll-free by calling 800 225-1153 from 8:00am to 12 midnight EST Monday-Friday and 8:30am to 5:00pm on weekends. If for some reason you can't reach us on our 800 numbers, call 304-428-4866.

Ordering By FAX

Complete our order form, and FAX it to us at 304-428-8271.

Ordering On The Internet

Visit us at www.woodcraft.com! You can place your order online, check its current status and track your shipment. Tracking and account info is available even if you ordered by phone or mail!

Shop At Our Stores

Woodcraft Stores are located in most major US cities!
Visit www.woodcraft.com to find the location nearest you.

Ordering Questions? email: custserv@woodcraft.com

Please call our Customer Service Dept. at
800 535-4482 from 8:30am to 5:00pm EST, Mon.-Fri., or write to:

Woodcraft, c/o Customer Service Dept.
P.O. Box 1686
Parkersburg, WV 26102-1686

Product Support email: tech@woodcraft.com

Need more information on any of our products?
Call our WOODCRAFT HOTLINE at 800 535-4486
from 8:30am to 6pm EST, Monday-Friday

Pricing

Woodcraft's goal is to maintain the published prices in this catalog for the period of time shown. However, due to unanticipated changes and/or typographical errors pricing may increase, or decrease, without notice. To obtain current pricing prior to ordering please visit www.woodcraft.com or call 800 225-1153. Retail store pricing may vary from the Internet or Catalog pricing.

Shipping & Handling

Woodcraft ships packages, depending on shipping package weight, via UPS Mail Innovations (a combination of UPS and USPS), UPS Sure Post (a combination of UPS and USPS), UPS Ground, UPS Second Day Air or UPS Next Day Air delivery plus a minimal handling fee. Delivery time is usually 2 to 6 business days for shipments to the contiguous 48 States. UPS Ground, Second Day Air or Next day Air offer faster delivery than Mail Innovations or UPS Sure Post which are more economical choices. Our Customer Service Department 800 225-1153 can assist you in determining your shipping cost for your order. Alaska and Hawaii are shipped via UPS Ground unless otherwise indicated. For products marked "Ships Direct from Manufacturer" the order will ship from the manufacturer's location within 5 business days. For faster delivery see Express Rates. Shipments outside the contiguous US are charged actual shipping expenses plus a minimal handling fee.

Express Rates - Yes, we ship overnight!*

In-stock orders received by Noon EST Monday through Friday can be air shipped that same day. Woodcraft does not ship on Saturday, Sunday or the following holidays: New Year's Day, Memorial Day, Independence Day, Labor Day, Thanksgiving Day, Christmas Eve and Christmas Day. If you order Friday before Noon EST, a UPS Next Day Air package will arrive on Monday. If you order Friday after Noon EST, a UPS Next Day Air package will ship on Monday and arrive on Tuesday. Mail Innovations and Sure Post may consist of a combination of UPS Ground Package and USPS delivery. Mail Innovations and Sure Post deliver Monday through Saturday. UPS Ground, UPS 2nd Day Air and UPS Next Day Air only deliver Monday through Friday. *Products marked "Ships Direct from Manufacturer" are not eligible for rush shipping. Flammable or hazardous items cannot be shipped by air. If your order contains a flammable item the entire order will be sent by ground.* Orders being shipped to AK, HI and any of the territories or possessions of the USA are shipped by UPS Ground shipping. Please contact our Customer Service Dept. for more information on 2nd Day or Next Day Air shipping options.

Freight Shipments

Items weighing more than 150 lbs., or of an unusual size, must be shipped by common carrier. These are charged based on our actual discounted rates plus a minimal handling fee. If the shipment is to a residence or if lift gate service is required, additional fees may be charged by the freight company. Truck shipments are tail gate deliveries. The driver will not take the item off the truck. It is your responsibility to arrange for your item to be removed from rear of the truck. Woodcraft's Customer Service Department at 800-535-4482 will gladly contact the freight company that services your area and prepare an estimate prior to completing your order. Shipments outside the contiguous US are charged actual shipping expenses.

162 Credit Card Orders: 800 225-1153

Free Technical Advice: 800 535-4486

www.woodcraft.com

D/S = Drop Ship Direct from Manufacturer

Your in-stock order will be shipped from the manufacturer to your doorstep! All Direct from Manufacturer items ship by ground to the 48 contiguous states. Items cannot ship to Alaska or Hawaii, PO Boxes, APO addresses or any of the US Territories. Express and overnight shipping are not available for these products. Manufacturer's Warranty: Because these items are purchased and shipped directly from the manufacturers, the manufacturer's warranty supersedes any offered by Woodcraft.

Non US Orders

We accept US funds only, and for your convenience we recommend you use a credit card or bank money order. Personal checks or money orders are not accepted unless drawn on a US bank. Orders being shipped outside of the USA and Canada are shipped by the carrier of your choice. Our Customer Service Dept. will contact you with options (land, sea and air) and the cost prior to processing your order. Taxes and duty are your responsibility and are not included in our quotes. Products marked "Ships Direct from Manufacturer" cannot be shipped outside the US.

Mail Preference

We occasionally make our customer list available to carefully screened companies whose products may interest you. If you prefer not to receive their mailings, please let us know. When contacting us, enclose your mailing label.

NOTE: California's Proposition 65 entitles California consumers to special warnings for products that contain chemicals known to the state of California to cause cancer and birth defects or other reproductive harm. As such, where applicable, a warning will be included on products sold in the state of California.

Returns/Exchanges & Sharpening or Engraving Services

Returns will be refunded in full, including shipping and return postage (at ground rates only), with exceptions noted below.

Domestic US Orders - If for any reason you are not satisfied with a product (except for power tools and items direct shipped from manufacturer, which are covered only by the manufacturer's warranty, as described below), please contact Woodcraft's Customer Service Dept., 800 535-4482, for assistance with a return authorization and shipping instructions for the product. PLEASE DO NOT RETURN THE ITEM TO US WITHOUT AUTHORIZATION.

Power Tools: These products are covered by the manufacturer's warranty, which supersedes any offered by Woodcraft. Returns of these products require pre-approval from Woodcraft Customer Service, and they may be subject to a restocking fee. A minimum 15% Restocking Fee applies to the return of CNC machines and 3D printers. Customer pays return shipping charges.

Ships Direct from Manufacturer (D/S): Products identified with "Ships Direct from Manufacturer" are shipped directly from the manufacturer and are covered by that manufacturer's warranty, which supersedes any offered by Woodcraft. "Ships Direct from Manufacturer" returns require pre-approval from Woodcraft Customer Service and may be subject to a restocking fee. Customer pays return shipping charges. Click on the "Ships Direct from Manufacturer" link on the specific product page for more details.

International Orders - If for any reason you are not satisfied with a product, contact us by email immediately. Please do not return the item to us without authorization.

Engraving & Sharpening: Please contact Woodcraft Order entry by calling 800 225-1153 for assistance with Engraving and Sharpening Services. Selected items for Sharpening or Engraving services may also be sent to:

Woodcraft Supply, LLC
406 Airport Industrial Park
Parkersburg, WV 26104-9778

ORDER FORM

All in stock orders received by 12pm EST are shipped out that same day!

Shipping & Handling

Woodcraft ships packages, depending on shipping package weight, via UPS Mail Innovations (a combination of UPS and USPS), UPS Sure Post (a combination of UPS and USPS), UPS Ground, UPS Second Day Air or UPS Next Day Air delivery plus a minimal handling fee. Delivery time is usually 2 to 6 business days for shipments to the contiguous 48 States. UPS Ground, Second Day Air or Next day Air offer faster delivery than Mail Innovations or UPS Sure Post which are more economical choices. Our Customer Service Department 800 225-1153 can assist you in determining your shipping cost for your order. Alaska and Hawaii are shipped via UPS Ground unless otherwise indicated. For products marked "Ships Direct from Manufacturer" the order will ship from the manufacturer's location within 5 business days. For faster delivery see Express Rates. Shipments outside the contiguous US are charged actual shipping expenses plus a minimal handling fee.

Woodcraft Express Shipping – Yes we ship overnight! Express Rates

In-stock orders received by Noon EST Monday through Friday can be air shipped that same day. Woodcraft does not ship on Saturday, Sunday or the following holidays: New Year's Day, Memorial Day, Independence Day, Labor Day, Thanksgiving Day, Christmas Eve and Christmas Day. If you order Friday before Noon EST, a UPS Next Day Air package will arrive on Monday. If you order Friday after Noon EST, a UPS Next Day Air package will ship on Monday and arrive on Tuesday. Mail Innovations and Sure Post may consist of a combination of



WOODCRAFT
Helping You Make Wood Work[®]

Woodcraft Supply, LLC
P.O. Box 1686
Parkersburg, WV 26102-1686

Please copy numbers from the address panel on back page and fill in:
Customer Number _____ & Key Code _____

Ordered By: _____

1704 WC

Name _____ Please print

Address _____

City _____ State _____ Zip _____

Daytime Phone No. _____ In case we have a question about your order.

Email Address _____

We'll email you when your order is picked and shipped. You can check delivery progress online.

Order Toll-Free 800 225-1153
Operators available 8:00AM-12 Midnight EST, M-F

8:30AM-5:00PM Weekends

For Customer Service call 800 535-4482 from 8:30AM to 5PM, M-F.
email: custserv@woodcraft.com

For Technical Advice call 800 535-4486 from 8:30AM to 6PM, M-F.
email: tech@woodcraft.com

Fax Your Order 1-304-428-8271

Ship to: If different than ordered by. Please print.

Name _____

Street _____

City _____ State _____ Zip _____

Gift Card Message _____

_____ From _____

60A60	2	Product Name	10	small	\$00.00	\$000.00
Stock Number	Qty.	Name of Product	Page	Size or Style	Price Each	Total Price



New Shipping & Handling Policy
Woodcraft Supply, LLC, only charges discounted shipping costs plus a minimal handling fee. Please use our toll-free order number 800 225-1153 to get a discounted shipping estimate. Save a stamp; our Order Entry Department will be happy to assist in entering your order when you call. You can also get discounted shipping rates plus handling by visiting woodcraft.com.

Sales Tax We are required by law to collect sales tax in certain states because of our retail presence. For orders shipped to any of the following states, add general state sales tax listed plus any additional county or local sales tax:

AL* 4%	HI* 4%	MD 6%	OH* 6.25-7.75%	VA* 5.3%-6%
AZ 5.6%	ID 6%	MI 6%	OK 4.5%	WA* 7-9.6%
CA*† 7.5%	IL 6.26%	MN* 6.88%	PA* 6-8%	WI 5%
CO* 7.5%	IN 7%	MO* 4.225%	RI 7%	WV* 6-7%
CT 6.35%	KS 6.5%	NC* 6.75-7.25%	SC* 6%	TX* 6.25%
FL* 6%	KY 6%	NE* 5.5%	TN* 7%	
GA* 4%	MA 6.25%	NY* 4-8.875%	UT* 4.7-8.35%	

Method of Payment:

- U.S. Funds Only
- American Express
 - Discover
 - MasterCard
 - Visa
 - Check or Money Order (Do not send cash)

Subtotal	
Shipping & Handling	See chart to the left.
Rush Shipping	See page 162
Sales Tax	See chart
Grand Total	

Questions? See Ordering Information, page 162



For These Services, Contact Customer Service
800 535-4482 from 8:30AM to 5PM, M-F.
email: custserv@woodcraft.com

CARD NUMBER

CARD SECURITY CODE

CARD EXPIRES

SIGNATURE

UPS Ground Package and USPS delivery. Mail Innovations and Sure Post deliver Monday through Saturday. UPS Ground, UPS 2nd Day Air and UPS Next Day Air only deliver Monday through Friday. Products marked "Ships Direct from Manufacturer" are not eligible for rush shipping. Flammable or hazardous items cannot be shipped by air. If your order contains a flammable item the entire order will be sent by ground.

Orders being shipped to Alaska, Hawaii and any of the territories or possessions of the USA are shipped by UPS Ground. Please contact our Customer Service Department 800 225-1153 for more information on 2nd Day or Next Day Air shipping options.

Freight Shipments

Items weighing more than 150 lbs., or of an unusual size, must be shipped by common carrier. These are charged based on our actual discounted rates plus a minimal handling fee. If the shipment is to a residence or if lift gate service is required, additional fees may be charged by the freight company. Truck shipments are tail gate deliveries. The driver will not take the item off the truck. It is your responsibility to arrange for your item to be removed from rear of the truck. Woodcraft's Customer Service Department at 800 535-4482 will gladly contact the freight company that services your area and prepare an estimate prior to completing your order. Shipments outside the contiguous US are charged actual shipping expenses.



WOODCRAFT GIFT CARD

Not sure what to get the woodworker in your life? Give them the freedom to get just the tools they want. Available in any dollar amount!
To order, call 800 225-1153, visit your local Woodcraft Store, or woodcraft.com.



Woodcraft is a member of the Direct Marketing Association and follows best industry practices in regards to mailing list maintenance and consumer privacy.

New Products

HOMERIGHT® Finish Max Fine Finish HVLP Sprayer



Paint and stain just about anything with the Finish Max HVLP Sprayer. We say anything because we sprayed undiluted chalk paint, and while we can't recommend you do that, the sprayer does have the power to do it. The Finish Max will handle any solvent, or water-based product – latex paint, milk paint, chalk paint, furniture paint, stains and finishes. Features include precision volume control and adjustable spray pattern, plus it comes with a viscosity cup, cleaning brush and the best instructions we've seen for getting the most from your sprayer. It's easy to set up, use and clean and comes with a manufacturer's Two-Year Warranty. For painting furniture, we recommend using the HomeRight Large Spray Shelter (162466); for smaller accessories use the Small Spray Shelter (162467).



162465\$69.99



A



B

HOMERIGHT® Spray Shelters

HOMERIGHT® Spray Shelters provide an enclosed spraying area that helps reduce overspray and drift – airborne finish that didn't make it to or stick to the piece being painted – something even HVLP sprayers have to a certain degree. Both shelters come in their own storage bag and have some unique features. **Small Shelter** is approximately 2½' x 3' x 3¼' when open. This is a three-sided shelter with a floor and rear vents to handle the air pressure the spray gun generates. It just pops open – no assembly required – and refolds when not in use. **Large Shelter** measures approximately

8½' x 8½' x 6' when set up. It is large enough to accommodate a buffet or similar sized project, and features include a mesh screen the drops over the opening to protect a newly painted or finished project. Setup is easy with two fiberglass supports inserted through channels to support the shelter and stakes for use outside – not unlike a tent for campers. This shelter does not have a floor, so a drop cloth is recommended to protect your shop or garage floor.

162466 (A) small shelter\$24.95
162467 (B) large shelter \$54.99



A



B



DAP® Weldwood® Contact Cements: Original, Nonflammable/Low VOC And Spray

DAP® Contact Cements meet the stringent requirements of the professional user. All are water- and heat-resistant when dry and can be used on an incredible range of materials: decorative laminates, veneers, paneling, wood, rubber, foam or cork to itself, particleboard, medium density fiberboard, drywall, wood, glass, metal or fiberglass; just to name a few. The **Original** solvent-based formula offers a 15-20 minute dry time, with 1½- to 2-hour open time; the **Non-flammable** low VOC, waterborne formula offers a 30-40 minute dry time, with a 2½-3-hour open time; and the **Spray** offers a 1-10 minute dry time before bonding and an open time of up to 2 hours.

161421 (A) Original, quart.....\$12.99
161422 (B) Nonflammable, quart..... \$21.99
161423 (C) Spray Adhesive, 16 oz.....\$12.99

TITEBOND® Quick & Thick Multi Surface Glue



Titebond® Quick & Thick Glue stays where you put it, and squeeze-out doesn't run nor drip. Ideal for vertical applications and filling small gaps. For wood, pottery, ceramics, glass, fabrics and most craft materials. Nontoxic, paintable and sets in 15 minutes. Available in 8 oz. bottles only.

162166\$4.99



Images not to scale



A



B



C

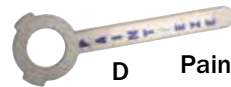

D

EZE-Solutions Paint-EZE Dispensers And Accessories

Nobody likes painting furniture and small jobs out of a can with all the drips, runs and mess around the rim. EZE-Solutions Paint-EZE™ Paint Dispensers solve the problem. Simply decant the paint into one of these Paint Dispensers using the EZE-Solutions Funnel (868140), and squeeze out exactly what you need where you need it. These no-mess, no-hassle, reusable containers not only act as dispensers but can also be used to store and mix paint. Two sizes are available, 16 oz. and a 32 oz. NOTE: Be sure to use the EZE-Solutions Wrench to tighten the dispensing end cap on the bottle. This helps prevent the bottle from leaking, and a tight cap keeps the paint from spilling out prematurely. All dispensers (bottles) and accessories are reusable, durable and ecologically friendly, because they conserve paint and keep it usable.

868136 (A) 16 oz. dispenser\$6.50
868137 (B) 32 oz. dispenser.....\$6.99
868140 (C) funnel\$6.50
868138 (D) wrench\$9.99

STAR 10 Paint Stripper

Star 10 is environmentally friendly and is safe to use on metal, wood and fiberglass, which means you can strip just about anything. Star 10 is comprised of three products: Phase 1 Paste to remove 99% of all finishes; Phase 2 Liquid for shellac, lacquer and stains; and Star 10 Aerosol, for vertical surfaces like doors and cabinets.



Phase 1 Paste	Phase 2 Liquid
812107 qt.\$24.99	812103 qt.\$21.99
812108 gal.\$64.99	812104 gal.\$49.99
812106 14 oz. Aerosol\$19.99	

BEHLEN Rockhard™ Waterborne Brushing Varnish

H. Behlen & Bro. wood finishing products come from a 128-year tradition of quality and expertise in finishing and furnituremaking. Since 1888, Behlen's products have been the top choice of professional and amateur craftsmen for easy controlled application and beautiful results. Continuing this tradition, Behlen has introduced Rockhard™ Waterborne Brushing Varnish in three sheens: Flat, Satin and Semi-Gloss. It's all about performance, and this new brushing varnish performs with the best. The low VOC urethane/acrylic blend is easy to use, fast drying, non-yellowing and has excellent leveling characteristics, as well as being tough enough to use on any interior surface. Plus the water white formula will let the true beauty of the wood/color shine through.



161404 flat (shown)\$25.99
161405 satin\$25.99
161406 semi-gloss\$25.99



Workshop Glue Injector Bottles, 6-pack

Six injector bottles with Luer Lock adapters and storage caps. Handy to have around, these bottles make good applicators for water-based glues and as oilers for camellia oil or other light machine oil. For pinpoint delivery, add Luer Lock needles.

159179\$9.99
LUER LOCK SS Tip Pack, 20 Gauge, 20 Pieces
159014\$4.99
LUER LOCK SS Tip Pack, 18 Gauge, 20 Pieces
159015 (A)\$4.99



See Page 122

New Products

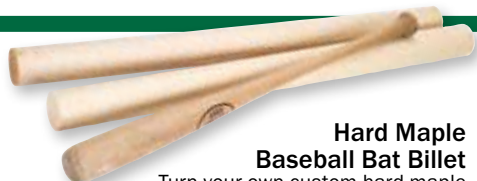

Hard Maple Baseball Bat Billet

Turn your own custom hard maple baseball bat with these hand selected trophy grade baseball bat dowels.

160198 2 3/4" D x 37" L.....\$24.49



Finished pieces are for display only

Whiskey Wood® Bourbon Whiskey Barrel Staves

These White Oak pieces come from genuine used Bourbon Whiskey Barrels that have some charring caused by firing the barrel prior to aging the whiskey for four or more years. Staves have been dried and brushed to remove excess char. Staves are, of course, bent to make the barrel, but we have cut out and milled pieces to remove much of the bend.

(A) Knife Scales, 3/8" x 1 1/2" x 5", 2-piece

162057 Cooperage Select.....\$9.29
162058 Black & Tannin.....\$9.29
162059 Distillery Reserve.....\$9.29

Pen Blanks, 3/4" x 3/4" x 5", 2-pc.

162060 Bourbon Stave.....\$9.19
162061 Rum Stave.....\$9.19
162062 Tequilla Stave.....\$9.19
162063 Red Wine.....\$9.19
162064 Red Wine Infused.....\$12.29

Turning Blank, 1" x 1 1/2" x 5"

162065.....\$9.19

(B) Cutting Board Kits

Reg. SALE:

162066 small 3/4" x 4 1/2" x 17"....\$24.99 **\$18.74**
162067 large 3/4" x 7 1/2" x 17"....\$39.99 **\$29.99**

Mimosa

Mimosa (*Albizia julibrissin*) is native to Asia and is widely planted as an ornamental tree. The color can vary from a light brown to a deeper golden, even a reddish-brown. It is quite easy to turn, and just a little oil brings out the full beauty in this wood.

851995 2" x 2" x 12".....\$8.99
162655 2" x 2" x 24".....\$16.99
852486 2" x 4" x 4".....\$7.99
852487 2" x 6" x 6".....\$11.99
162656 3" x 3" x 12".....\$19.99
162657 3" x 6" x 6".....\$19.99



Reclaimed

Antique French Oak

Cut between 1700 and 1800 for use in the construction of factory buildings and houses, Antique French Oak was actively being used during the French Revolution from 1789 to 1799. During a remodel of a French mill, we obtained a limited quantity of stock that we are offering in three sizes. Oak comes with a Certificate of Authenticity.

162054 3/4" x 3/4" x 5", 2-piece.....\$20.39
162055 1" x 1 1/2" x 5".....\$20.39
162056 1 1/2" x 1 1/2" x 3".....\$20.39



M.POWER Double-Sided Credit Card Diamond Stone With Handle

M.POWER'S Double-Sided Credit Card Diamond Stone features Diamond Cross™ technology that combines an unparalleled abrasion rate, outstanding durability and ergonomics. A stainless steel core makes the double-sided 300/600-grit stone 100% rustproof. Stone comes with a clever removable grip and M.POWER'S Three-Year Guarantee.

161391.....\$22.50



M.POWER 5N1 Double-Sided Diamond File With Handle

M.POWER'S 5N1 Double-Sided Diamond File features Diamond Cross™ technology that combines an unparalleled abrasion rate, outstanding durability and ergonomics. The double-sided 300/600-grit stone is 1" wide by 5" long, making it useful for sharpening scissors, gardening shears and loppers, knives of all kinds, circular saw blades and lawn mower blades. It can be used indoors and outside without fear of corrosion, thanks to its stainless steel core. Comes with a clever grip handle and M.POWER'S Three-Year Guarantee.

161392.....\$22.50



M.POWER Double-Sided Diamond Router Bit Sharpener With Handle

M.POWER'S Router Bit Sharpener is the world's first diamond stone specifically designed to sharpen router bits using exclusive Diamond Cross™ technology. A stainless steel core makes the double-sided 300/600-grit stone 100% rustproof. Stone comes with a clever removable grip and M.POWER'S Three-Year Guarantee.

161390.....\$19.95



M.POWER Diamond Stone Holder

M.POWER'S Diamond Stone Holder grips any brand of diamond credit card, solid surface diamond bench stone or double-sided interrupted surface bench stone. Two strong rare-earth magnets instantly lock to the metal base of the diamond stone as the non-slip rubber holder grips the work surface.

161394.....\$11.99



Submarine

Inertia Pen Kit

Dive the depths of pen making with the Submarine Inertia Pen Kit. From the bow to stern, small details have been added to create a realistic looking submarine. To accommodate touch screen devices, the submarine's bow contains a soft tip non-marring stylus. The Submarine is part of the Inertia Series of pen kits that require just a flick of the wrist to extend the refill to write or retract it when finished. Kit requires a blank of wood or man-made material and a mandrel, all sold separately.

162196.....\$19.99

151257 10.5mm pen maker's bit.....\$8.39

162605 bushings.....\$6.50



P-40 Warhawk

Inertia Pen Kit

One of World War II's most famous fighter planes was the P-40 Warhawk. Capture a piece of history and turn a P-40 Warhawk Pen today, so you can soar through that pile of paperwork building up on your desk that needs to be signed. The P-40 kit is part of the Inertia Series of pen kits. With just a flick of the wrist, the ink refill extends to write. To retract the ink refill, flick the wrist again. Kit requires a blank of wood or man-made material and a mandrel, all sold separately.

162195.....\$19.99

151257 10.5mm pen maker's bit.....\$8.39

162605 bushings.....\$6.50



Fireman's Click Ballpoint Pen Kit – Gunmetal & Chrome

First responders and firefighters make the conscious decision every day to work under some of the most dangerous conditions imaginable. The Fireman's Pen Kit pays homage to all of the brave men and women who put their lives at risk every day to protect and save the lives of others. Thank you for all you do! Pen blank, and mandrel sold separately.

NOTE: Due to the wall thickness of the brass tube it will be necessary to use a 3/8" pen mill pilot shaft.

162554.....\$19.99

149127 10mm pen maker's bit.....\$8.99

160834 bushings.....\$4.99



PowerFlex Titanium 9" Shop Scissors With Ergonomic Grip

Cut veneer, caning, stencils, leather and more. These titanium bonded shears are three times harder than regular steel and hold a sharp edge longer. For right- or left-handed users, deliver clean cuts. Overall Length: 9".

162302.....\$19.99

New Products



RIKON 8" Low Speed Buffer Model 81-608

This 1/2 HP Rikon Buffer is perfect for polishing surfaces of woods, metals, plastics, hardware, rocks, jewelry and more! At 1,750 RPM, it is excellent for maintaining sharp edges on chisels and blades, putting buffed finishes on woodturnings, or just keeping other shop hand tools and home furnishings in tip-top, rust-free, polished condition. The long lasting, spiral sewn cloth buffing wheels are positioned on 5 1/2" long shafts to give ample space for maneuvering buffing projects. Shipping weight, 26 lbs. 5-year warranty.

866004 \$159.99

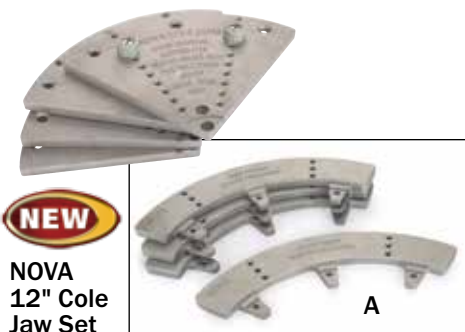

NOVA 12" Cole Jaw Set

& Cole Jaw Accessory Extensions

Expand the range and capacity of standard NOVA Chucks with this new accessory – the NOVA 6040 Large Cole Jaw Set that features a 12"/304mm bowl diameter capacity and is designed for the re-chucking of bowls and platters to remove chuck marks, to add decoration or to reshape the bottoms of bowls and platters previously turned. This set also possesses a unique feature that enables it to be added to the NOVA 6039 Cole Jaw Extension Kit (sold separately) to increase the capacity from 12"/304mm to 15"/381mm. Suitable for lathes with a minimum 16" swing diameter but **NOT** for the Standard Nova 10" JSCOLE or Mini 8" 6006 Cole Jaws.

161469 6040 12" cole jaw set \$89.99

161470 (A) 6039 cole jaw acc. extens. \$39.99

NOVA Flexible Point Drive Center

Designed to mount perfectly in your Nova four jaw chucks, the Nova Flexible Point Drive Center features a spring-loaded center point that allows easy setup of your workpiece between centers and is less likely to split your workpiece, compared to standard spurs. The multi-tooth design spreads the pressure over the entire surface of the turning stock, which provides a positive drive force. With light or heavy tailstock pressure, the Flexible Point Drive Center will stop if a catch occurs, minimizing damage while being able to power through the heaviest of cuts. Available in three sizes:

162028 9019, 1/2" \$39.99
162029 9020, 7/8" \$39.99
162030 9021, 1 1/4" \$49.99

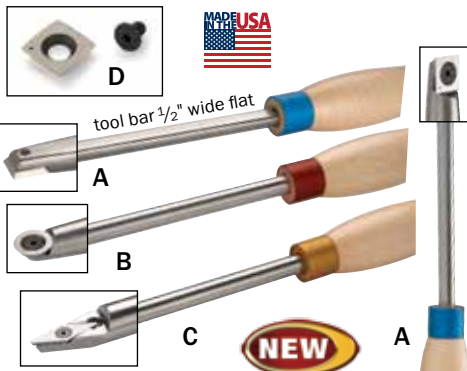

The Axe Carbide Woodturning Tools

The Axe™ replaceable carbide tip woodturning tools from Carter Products® are setting a new industry standard in the turning world. Made in the USA, the unique design of these tools features a 16" solid Maple handle. Ergonomically shaped, the handles have two large flats incorporated to provide positive registration in the hand while providing hours of comfortable turning. Another feature of these tools is the 5/8" round 303 stainless steel tool bar. A 1/2" flat has been machined onto the tool bar to provide a secure purchase on the tool rest.

You no longer need to worry about sharpening your turning tools. To maintain razor-sharp cutting edges, simply loosen the setscrew and rotate the cutter to a new edge when one becomes dull. Additionally the design of the cutters does not require you to "find the bevel" like traditional turning tools. Place the tool onto the rest flat and parallel to the ground, advance the tool slowly into the workpiece, and begin cutting. 16" handles.

162508 (A) with sq. & rad. sq. cutters \$99.99

162509 (B) with round cutter \$99.99

162510 (C) with diamond cutter \$99.99

162511 replacement cutter, square \$14.99

162512 (D) repl. cutter, radiused sq. \$14.99

162513 replacement cutter, round \$17.99

162514 replacement cutter, diamond \$18.99

Shown as a finished kit,
turning blanks sold separately



Wall Street II Ballpoint Pen Kit With Carbon Fiber Coating

The sleek, smooth and refined lines of this pen provide a distinct feel in your hand. Utilizing single-tube construction, this pen features the easiest assembly of any kit we offer. Nib/nib holder, center ring and the top finial/clip are both preassembled. Simply turn the body, press in the top finial/clip assembly, screw the ink refill mechanism on the nib assembly, push the two halves together, and you are finished. Kit features a smooth single twist mechanism and quality Parker style refill. Requires a wood or man-made pen blank, 27/64" drill bit, pen mandrel and bushings, all sold separately

162552 chrome w/carbon fiber coating .. \$12.99

162553 gunmetal w/carbon fiber coating \$12.99



SORBY Patriot Wobble Chuck

The Robert Sorby Wobble Chuck provides the turner the opportunity to experiment with a multitude of offset turning techniques, such as creating quirky trinket boxes, offset goblets and ornamental spoons. The steel body measures 2" in diameter and is equipped with a 1 3/4" dovetail spigot used to secure it neatly in any standard 2" (50mm) jaws of a four-jaw chuck. Turning stock can be held by using one of three different methods: (1) use the supplied 1" wood screw; (2) remove the wood screw and secure stock to the chuck like a faceplate; (3) or use both methods together. The body of the chuck is split at an angle; when the top half is rotated it causes the workpiece to be tilted. The amount of tilt varies by the amount of rotation. Registration marks on the body allow for repeatability.

856141 \$99.99



Hold Fast® Lathe Buffing Extenders

Utilizing a Hold Fast 8" Lathe Buffing Extender makes buffing and polishing deep bowls or vessels easier than ever! With two options to choose from, 1" x 8 TPI or 1 1/4" x 8 TPI, we've got you covered. Each extender is threaded to accept any buffing accessory or bowl buff that uses a 3/8" threaded bolt fastening system like the Beall Bowl Buffs. Buffing Extenders include a no-lock spindle washer for easy removal.

162260 1" x 8 TPI \$25.99

162261 1 1/4" x 8 TPI \$25.99



NOVA Modular Lathe Tool Rest System

The Nova Modular Lathe Tool Rest System is a flexible, mix and match system of posts and bars used to create the ultimate customized tool rest to match your lathe. These rests feature a hardened stainless steel rod attached to a cast steel body. The smooth stainless steel rod allows the tool to effortlessly glide across the tool rest, providing complete control, while the curvature of the rest provides a safe and comfortable outlet for your hand to move across. All parts are sold separately for complete customization.

162031 (A) 5/8" x 3 1/4" post \$9.99

162032 (B) 1" x 5" post \$11.99

162033 (C) 1" x 8" post \$13.99

162034 (D) 4" x 101mm tool rest bar \$21.99

162035 (E) 6" x 150mm tool rest bar \$26.99

162036 (F) 12" x 300mm tool rest bar \$36.50

Visit Your Local Store or
woodcraft.com for full instructions.

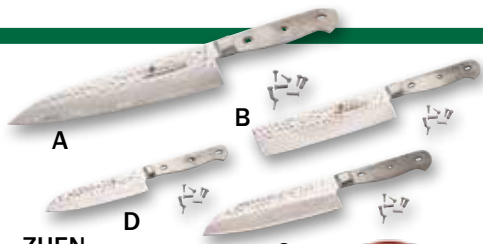

ZHEN Hammered Surface Damascus Knife Blanks

ZHEN Hammered Surface Damascus Knife Blanks are forged in Japan utilizing years of knowledge and skill and then imported to Taiwan. The blades are forge welded using 66 layers of steel around a single core layer of VG - 10 stainless steel (HRC60-62). Each blade has its own unique surface pattern and edge that remains extremely sharp. The hammered or tsuchime surface finish acts like a series of hollow-ground cavities that reduce slicing drag. Hone your blades weekly with a steel or ceramic rod to keep them sharp, or sharpen with a whetstone at an angle of 15°-20°. Scale material (handle) and epoxy sold separately.

- 161800 (A) chef's knife\$89.99
- 161801 (B) nakiri knife\$89.99
- 161802 (C) large santoku knife \$81.99
- 161803 (D) small santoku knife \$51.99



ZHEN Chopping Knife Damascus Santoku Blank

ZHEN Premium Damascus Knife Blade Blanks are made in Japan by forge welding 66 layers of steel together around a core layer of VG - 10 steel (HRC60-62), giving you a high quality blade with its own unique surface pattern and an edge that remains extremely sharp. Use this knife with a rocking action that makes chopping chores a breeze. Blade length is 6³/₄" x 5⁵/₆₄" thick (171mm x 1.98mm), with an overall length of 11¹⁵/₁₆". Handle material sold separately.

- 161804 \$81.99



ZHEN Cheese Knife High Carbon Steel Blank

This super sharp cheese knife blade blank is constructed from 440C high carbon stainless steel, for longer life and improved stain resistance. The sharpened fork ends allow you to pick up your favorite cheese or meat while keeping your fingers clean. Blade length is 4³/₄" x 1¹/₁₆" thick (120mm x 1.6mm), with an overall length of 9¹/₄". Handle material sold separately.

- 161806 \$19.99



ZHEN AUS 10 Chopping Knife 3-Layer Santoku Blank

Designed for the chef at heart, this ZHEN Santoku Chopping Knife would make a great gift for the cook in your family. Although excellent for slicing and downward push cuts, this knife blade is best used by taking advantage of the beautiful rocking action allowed by the deep belly that makes chopping chores a breeze. AUS 10 steel (HRC59-61) forged three-layer blade length is 6³/₄" long x 1¹/₁₆" thick (171mm x 1.98mm), with an overall length of 11¹⁵/₁₆". Handle material sold separately.

- 161805 \$37.99



These knives are sharp, and even sharper with your custom handle!

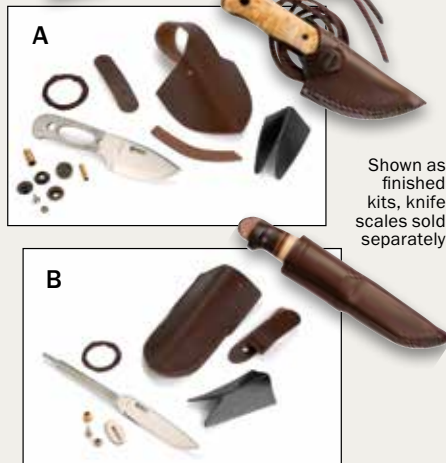

WoodRiver® Waxed Nylon Thread

WoodRiver® professional saddle stitching polyester thread, coated with pure beeswax. Dark brown.

- 162626 \$3.99

Shown as finished kits, knife scales sold separately



HELLE Fixed Blade Knife Kits

Since Steinar and Sigmund Helle began producing knives at their farm in Homeland, Norway, in 1932, Helle knives have represented the very best traditions of Norwegian craftsmanship. Today, much of their production is still done by hand.

The triple laminated stainless steel blade core is made of high alloy steel for a lasting, durable and razor-sharp edge. Helle also has added two layers of tough stainless steel (18/8) to protect the blade against breakage and corrosion. Kits include all knife parts, sheath pieces, fasteners and stitching thread. Handle material and sewing needles for stitching sold separately.

- 162484 (A) Måndra, 5⁷/₈" overall \$134.99
- 162485 (B) Harding, 8¹/₄" overall \$106.99
- 162486 (C) Helle GT, 9³/₄" overall \$129.99

WoodRiver® Stitching Needles

WoodRiver® blunt needle with an extra-large eye. Easy threading with a larger gripping surface. 10 in a pack. 3⁵/₆₄" x 2".

- 162627 \$3.99

Shown as finished kits, wood sold separately



Camillus Tyrant Fixed Blade Knife Kit

For over 135 years Camillus Cutlery has been supplying the world with innovative, reliable, quality-made knives that stand the test of time. The Tyrant is constructed from 1¹/₈" Carbonitride Titanium Q2 cutlery-grade steel and has been through-hardened to hold a fine edge. Shape, mount and finish your custom handle to create a truly one-of-a-kind, high-quality knife. The 7¹/₄" overall length and 3" blade make this a great general-purpose hunting, fishing or camping knife. Kit includes blade, screw-together rivets, and fitted black leather sheath with built-in sharpener. Scale material (handle) and epoxy sold separately.

- 162378 \$57.99



Camillus HT-7 Fixed Blade Knife Kit

Since 1876, Camillus Cutlery has been producing and supplying the world with innovative, reliable, quality-made knives. The HT-7 is constructed from 5³/₃₂" Titanium Bonded Cutlery-grade steel and has been through-hardened to hold a resilient edge. Shape, mount and finish your custom handle for a truly one-of-a-kind, high-quality knife. The 7" overall length and 3¹/₄" blade make this a great general-purpose hunting, fishing or camping knife. The kit comes with blade, screw-together rivets, and fitted black nylon sheath. Scale material (handle) and epoxy sold separately.

- 162377 \$16.99



Camillus Bushcrafter Fixed Blade Knife Kit

Camillus Cutlery ... unparalleled, unprecedented and unleashed, since 1876. The Bushcrafter is made in the USA from the highest quality 1095 high carbon steel. The 1¹/₈" thick steel blade has been through-hardened to hold an edge and heat-colored to create a flint grey finish. Shape, mount and finish your custom handle for a truly one-of-a-kind, high-quality knife. 8¹/₂" overall length and 4" blade help to make this a great general-purpose hunting and survival knife. The kit comes with blade, screw-together rivets, and fitted leather sheath with strap that doubles as a bow drill string. Scale material (handle) and epoxy sold separately.

- 162379 \$84.99



Custom Koozie Turning Kit

Kit includes all the parts you need to turn a custom beverage holder for a 12 oz. to 16 oz. bottled or canned beverage. Requires 3¹/₂" x 3¹/₂" x 6" blank. Includes (1) custom cup ring, (1) koozie, and detailed instructions.

- 162632 (A) blue \$6.99
- 162633 (B) red \$6.99
- 162634 (C) brown \$6.99

On Sale Now!

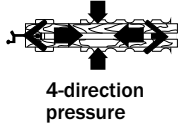
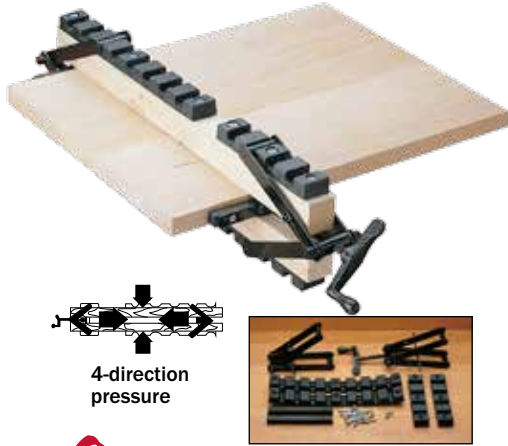

Save \$6⁵⁰
\$24⁹⁹

WoodRiver® 4-Way Clamping System

- Applies Equal Pressure On All Four Directions
 - Includes 2 Clamps, 2 Short Bars, 2 Long Bars, Screws (2 x 4s Not Included)
- 125392 • reg. \$31.50



Save \$12⁵⁰
\$19⁹⁹

Bessey Angle Clamp

- Holds And Aligns Material At 90° Angle
 - Die-Cast Jaws Coated To Protect Work
 - Clearance Provided For Adding Fasteners
 - Adjust Automatically To Wood Thickness
 - Includes Two Table Mounting Brackets
- 03W52 • reg. \$32.50



Save 25%

2" - 5" Heavy-Duty Casters

- Load Rating Is 132 lbs. To 300 lbs.
 - Choose From Fixed Base, Spindle And Double Locking Casters
- reg. \$12.25 - \$22.99
SALE \$9.18 - \$17.24



Save \$19
\$29⁹⁹

Pfeil Swiss Made Scorp

- Width Of Offset Blade 1 1/4"
 - Overall Length 7"
 - Roughing-Out Tool For Making Bowls, Spoons, And Similar Concave Shapes
 - Hand-Sharpened
- 11V51 • reg. \$48.99



Save \$18⁵⁰
\$19⁹⁹

Japanese "Kugihiki" Flush Cutting Saw

Allows The Cutting Of Dowels, Pegs, Through Tenons And Excess Trim Without Marring The Surrounding Surface

12F24 • reg. \$38.50



Save \$5
\$19⁹⁹

Winbag

- Positioning Window And Door Frames
 - Lifting Doors On Or Off Hinges
 - Leveling And Adjusting Appliances
 - Use As A Soft Shim For Delicate Surfaces
 - Range: 3/32" To 2" Gaps
 - Weight Capacity: 300 lbs.
 - Bag Size: 6 1/4" W x 5 3/4" L
- 862541 • reg. \$24.99

Save \$6
\$27⁹⁹



Snappy® Set of 3 Plug Cutters

- 1/4", 3/8" & 1/2"
 - Hex Drive Shank
 - Hardened Steel For Long Life
 - Tight Fit; No Glue Needed
 - Match Wood Grain To Conceal Screw
 - Tapered Sides And A Chamfered End For Easy Start
- 146723 • reg. \$33.99



Save \$2
\$7⁹⁹



WoodRiver®

4-Piece Set Of Palette Knives

- Great For Mixing Putty, Epoxy And Color, As Well As Making Small Repairs
 - Durable Wood Handles
 - Flexible, Yet Tough, Stainless Steel Blades
 - Easy To Clean And Almost Maintenance Free
- 153921 • reg. \$9.99

Save \$3
\$29⁹⁹ each



General Finishes Enduro-Var Top Coat Quarts

- Water Based Urethane
- Looks More Like An Oil Varnish Than A Water Coating
- Ambers Slightly
- Very Durable Coating
- High Water Resistance



151026 Glossreg. \$32.99
 151028 Semi-Glossreg. \$32.99
 151030 Satinreg. \$32.99

On Sale Now!

Save **55%** *Limited Quantities!*

Purpleheart Dimensioned Lumber

(*Peltogyne spp*)

- Central And South America
- Medium To Hardwood With Tight, Fairly Straight Grain And Moderate To Coarse Texture
- Bright Purple When Cut, It Darkens To A Deep Purplish-Brown
- Boards Are Surfaced Four Sides

	reg.	SALE
153701 3/4" x 3" x 24".....	\$12.99	\$5.84
153702 3/4" x 3" x 36".....	\$14.99	\$6.74
839670 3/4" x 4" x 24".....	\$15.99	\$7.19
839671 3/4" x 4" x 36".....	\$18.99	\$8.54
153699 3/4" x 5" x 24".....	\$18.99	\$8.54
153700 3/4" x 5" x 36".....	\$25.99	\$11.69



Receive A **FREE**

KREG® Multi-Mark Marking Gauge

When You Purchase The KREG® Cabinet Hardware Jig, Drawer Slide Jig & Concealed Hinge Jig Together!

The **KREG® Cabinet Hardware Jig** is great for updating your cabinets or furniture as well as new hardware installation on your building projects. The **KREG® Drawer Slide Jig** takes the guesswork out of installing drawer slides. This easy-to-use jig holds slides in position as you drill mounting holes in the cabinet, and it supports drawer boxes while mounting slides to the drawer. Mounting Concealed hinges requires drilling a large hole at a very specific position and depth. The **KREG® Concealed Hinge Jig** takes the guesswork out of drilling those holes, and allows you to do it using your drill motor and the carbide-tipped bit that comes with the jig.

162005 Cabinet Hardware Jig	\$24.99
162006 Drawer Slide Jig	\$24.99
162007 Concealed Hinge Jig	\$29.99
150872 Multi-Mark Marking Gauge..	\$14.99 Value – FREE When You Buy All 3 Jigs!

(Clamps Shown Sold Separately)

Save **40%**
\$3419



3-Piece Padauk Turning Pack

- African Padauk (*Pterocarpus soyauxii*) From Tropical Africa
- 3 Sizes For A Variety Of Turning Projects

- 3" x 3" x 12"
- 3" x 5" x 5"
- 2 1/2" x 6" x 6"

162648 • reg. \$56.99

Save **\$15**
\$149.99



Arbortech Turbo Plane

- Universal Freehand Wood Shaping Tungsten Carbide Toothed Blade
- Can Be Used In A Number Of Ways To Create Different Profiles And Finishes
- Specifically Designed To Be Laid Flat With A Rotary Planing Action
- Has No Cutting Edge On The Outer Perimeter, Which Makes It Safer And Easier To Use

154591 • reg. \$164.99

Save **\$5**
\$14.99 each

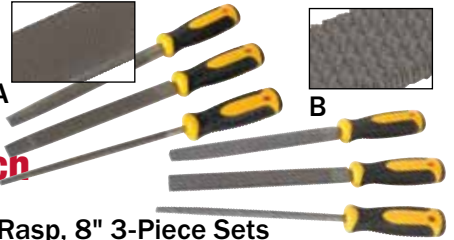

Double-Cut Wood File and Rough-Cut Rasp, 8" 3-Piece Sets

- Sets Each Contain Round, Half-Round And Flat (No Safe Edge) Profiles
- File Set Has Double-Cut Teeth
- Rasp Set Has Aggressive Rough-Cut Individual Teeth
- Comfortable Plastic Handle With A Rubberized Grip
- Tools In Both Sets Are 12 1/2" In Overall Length, With 7" (Length Of The "Belly") Of Teeth

162413 (A) 3-Piece File Set.....	reg. \$19.99
162414 (B) 3-Piece Rasp Set.....	reg. \$19.99

Save **\$50**
\$99.99



Super-Duty Universal Mobile Base PM-3500

- All-Steel Construction Uses Tubular Steel Rails To Adjust To Various Rectangles
- Heavy-Duty 1,500-lb. Capacity Accommodates Most Woodworking Machinery
- Foot Operated Steel Locking Levers With 3" Non-Marring Ball Bearing Wheels And Casters
- Adjusts From 18 1/4" x 23 1/2" To 28" x 33 1/2"

865291 • reg. \$149.99



Save **15%**
\$17.84 each

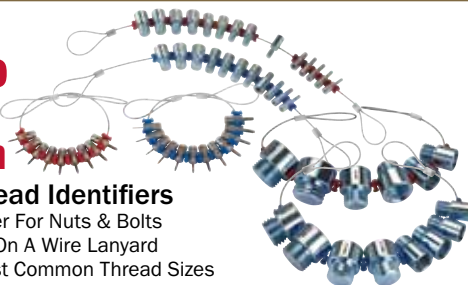

Thread Detective/Thread Identifiers

- Easy-To-Use Thread Identifier For Nuts & Bolts
- Gliding Gauges Assembled On A Wire Lanyard
- Include A Range Of The Most Common Thread Sizes
- All SAE/Inch Have Red Spacers, And Metric Have Blue Spacers

162452 Mini SAE/Inch, 1-64 – 5x40	reg. \$20.99
162453 Mini Metric, M1.2x0.25 – M3.5x0.35	reg. \$20.99
158931 SAE/Inch, 6-32 – 1/2"x20	reg. \$20.99
158932 Metric, M4x0.7 – M12x1.75	reg. \$20.99
160072 JUMBO SAE/Inch, 5/8" -11 – 1"x12	reg. \$20.99
160073 JUMBO Metric, M4x1.5 – M20x1.5	reg. \$20.99



Catalog items with this logo can be laser engraved.

PRSRT STD
 US POSTAGE
PAID
 WOODCRAFT
 SUPPLY, LLC

Customer Number

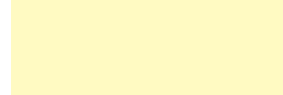
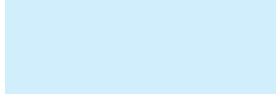

*TOGETHER, WE CAN
 CREATE ANYTHING®*

Sale

Sale prices good March 24 through April 27, 2017, unless otherwise noted.



*Excludes CNC Machinery & Industrial Machinery.

Save **\$150**
\$849.99

NOVA 1624 Type II Wood Lathe

Teknatool's newest lathe is packed with features and quality that you'd expect from a much more expensive lathe! Well designed, with high quality components and great capacity, this lathe has the ability to meet the needs of any turner for a lifetime. Includes: NOVA 1624 II Lathe, Stand, Spur Drive Center, Live Center, 3" Faceplate, 12" Tool Rest and Manual.

Specifications:

- 16" Of Inboard Capacity
- 29" Of Outboard Capacity
- 1 1/2 HP Custom Designed Motor
- 24" Between Centers
- 8 Speeds (214 - 3,600 RPM)
- Forward & Reverse Motor Function

- Cam Operated Belt Drive
- 1 1/4" 8 TPI Spindle
- 24-Position Spindle Index With Spindle Lock
- True 360° Swivel Head

*Shipping weight 260 lbs.

*SHIP. WGT: Items weighing more than 150 lbs., or of an unusual size, must be shipped by common carrier. These are charged based on our actual discounted rates plus a minimal handling fee. If the shipment is to a residence or if lift gate service is required, additional fees may be charged by the freight company.

Save **\$40**
\$129.99

WoodRiver® Benchtop Spindle Sander

- Motor: 3 1/2 Amp, 120-Volt, Single Phase
- Sanding Height: 3 5/8" With 5/8" Stroke
- 4 1/2" L Drums: 1/2", 3/4", 1", 1 1/2", 2" & 3"
- Includes: 6 Sanding Sleeves & Table Inserts; 5 Rubber Sanding Drums & Drum Washers

157889 reg. \$169.99
 149375 120-Grit Assortment Pack.....\$11.99